

The

Wireless World

6^D

THE PRACTICAL

RADIO & TELEVISION JOURNAL

Thursday, August 3rd, 1939.



HIGH VOLTAGE EFFECTS

VALVE VOLTMETERS OF ALL TYPES.

Miniature Valve Voltmeter Type 105X

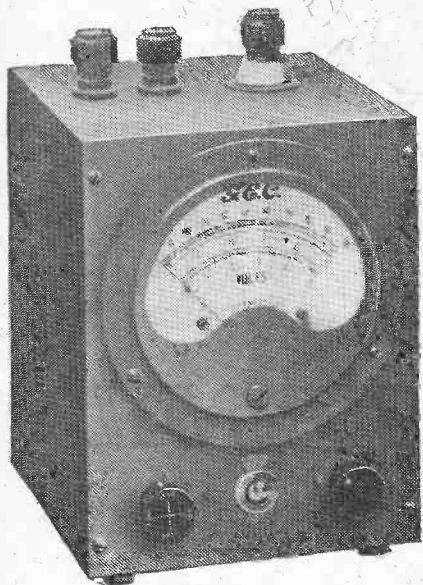

A simple, inexpensive, accurate Valve Voltmeter, completely self-contained, operating from a 3-volt torch battery fitted within its case.

A highly sensitive microammeter is used in conjunction with a diode rectifier, the diode making the circuit substantially independent of valve characteristics, and permitting valve replacement without disturbing the calibration.

The battery voltage is kept constant by means of a rheostat and a voltage range selector switch is provided.

Of robust construction, this instrument is ideal for general test purposes on Radio, Audio or Power frequencies in the Laboratory, Test Room or Workshop, wherever voltage measurement with negligible current consumption is essential.

SPECIFICATION :

VOLTAGE RANGES

Three Ranges: 0/5v, 0/25v and 0/100v.

FREQUENCY RANGE

20 cycles/p.s. to 10 megacycles/p.s.

ACCURACY

5v. Range $\pm 3\%$. 25v. and 100v. Range $\pm 2\%$.

INPUT IMPEDANCE

100v. Range, $\frac{1}{2}$ megohm. 25v. Range, $\frac{1}{2}$ megohm.
5v. Range, 50,000 ohms.

INPUT CAPACITANCE. 15 μ F.

DIMENSIONS. $7\frac{1}{2}'' \times 5\frac{1}{2}'' \times 4\frac{1}{2}''$

NETT WEIGHT. 4 lbs. 12 oz.

FINISH. Grey Enamel.

PRICE—£12-2-0.

Acorn Triode H.F. Valve Voltmeter Type 106X

An instrument for precision measurement of low voltages at very high frequencies.

The Acorn Valve Voltmeter is of the Anode Bend type. The valve, a G.E.C. acorn pentode connected as a triode and the by-pass condensers, are built into a brass head piece, which is on the end of a self-supporting flexible metal tube, so that the valve can be brought within one or two inches of the point at which voltage is to be measured. The input impedance is very high being due only to valve losses. Input capacitance is approximately 3.5 μ F. It is calibrated in R.M.S. values for sinusoidal wave form. Since the electrode clearances are very small the electron transit time is low compared with any frequencies up to 50 megacycles/sec., thus the damping imposed by use of a valve of this type is very small compared with the conventional type of valve, the impedance of which may go down as low as 10,000 ohms at 50 megacycles/sec.

SPECIFICATION :

VOLTAGE RANGES. Three ranges : 0-1v, 0-3v, and 0-15v.

FREQUENCY RANGE. 20 cycles/sec. to 50 megacycles/sec.

ACCURACY. $\pm 2\%$ of full scale deflection on each range. Calibration to $\pm 1\%$ at 800 p.p.s.

INPUT IMPEDANCE. Approx. 700,000 ohms at 50 megacycles/sec., due only to valve losses.

INPUT CAPACITANCE. Approx. 3.5 μ F. with head ; 3.0 μ F. without head.

POWER SUPPLY. 4v. 1a. Accumulator connected externally. 90v. H.T. Battery housed in case. (Supplied with contact.)

DIMENSIONS. $14'' \times 7\frac{1}{2}'' \times 7''$ overall, excluding valve head and tube.

NETT WEIGHT. 18 $\frac{1}{2}$ lbs. including H.T. Battery.

FINISH. Grey Enamel.

We shall be pleased to send full details of these instruments and other Voltmeters for use up to the highest radio frequencies and also details of other H.F. measuring apparatus, on receipt of details of your requirements.

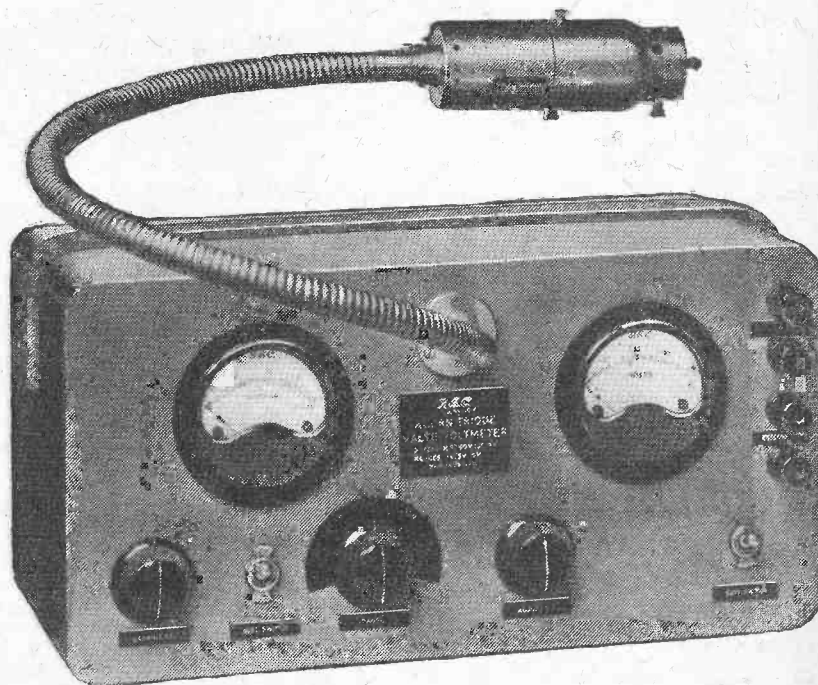

PRICE—£32-9-0.

SALFORD ELECTRICAL INSTRUMENTS LTD.

PEEL WORKS, SALFORD, 3.

Telephone: BLACKFRIARS 8888 (3 lines)

Telegrams and Cables: "SPARKLESS, MANCHESTER"

PROPRIETORS: THE GENERAL ELECTRIC Co. Ltd., OF ENGLAND

The Wireless World

THE PRACTICAL RADIO JOURNAL
29th Year of Publication

No. 1040.

THURSDAY, AUGUST 3RD, 1939

VOL. XLV. No. 5.

Proprietors : ILIFFE & SONS LTD.

Editor :
HUGH S. POCKOCK.

Editorial,
Advertising and Publishing Offices :
DORSET HOUSE, STAMFORD STREET,
LONDON, S.E.1.

Telephone : Waterloo 3333 (50 lines).
Telegrams : "Ethaworld, Sedist, London."

COVENTRY : 8-10, Corporation Street.
Telegrams : "Autocar, Coventry."
Telephone : 5210 Coventry.

BIRMINGHAM :

Guildhall Buildings, Navigation Street, 2.
Telegrams : "Autopress, Birmingham."
Telephone : 2971 Midland (3 lines).

MANCHESTER : 260, Deansgate, 3.
Telegrams : "Iliffe, Manchester."
Telephone : Blackfriars 4412 (4 lines).

GLASGOW : 26B, Renfield Street, C.2.
Telegrams : "Iliffe, Glasgow." Telephone : Central 4857.

PUBLISHED WEEKLY. ENTERED AS SECOND CLASS MATTER AT NEW YORK, N.Y.

Subscription Rates :

Home and Canada, £1 10s. 4d.; other countries, £1 12s. 6d. per annum.

As many of the circuits and apparatus described in these pages are covered by patents, readers are advised, before making use of them, to satisfy themselves that they would not be infringing patents.

CONTENTS

	Page
Editorial Comment	93
Distortionless Detection	94
Problem Corner	96
Totalitarian Suppression	97
Danger—High Voltage!	99
New Apparatus Reviewed	102
Five-Metre Signals and the Weather	103
Four-Band Transmitter (concluded)	105
Television Programmes	106
News of the Week	107
Mastering Morse	109
Random Radiations	110
Letters to the Editor	111
Unbiased	112
Short-Wave Stations of the World	113
Recent Inventions	114

EDITORIAL COMMENT

Weather and Wireless Forecasting U-S-W Conditions

EVERYONE knows that weather is a strictly localised affair, and that, as often as not, the area affected by a given set of conditions is extremely limited. The propagation of wireless signals, on the other hand, is a matter of comparatively enormous distances, covering areas in which a wide diversity of weather conditions are likely to exist. Except in relation to atmospheric interference due to near-by thunderstorms, it seems profitless to attempt to trace any definite connection between the two phenomena.

But ultra-short-wave signals are an obvious exception. The range of these is normally so limited that even at ranges considerably beyond that usually obtained it is quite possible that the path of the signals may lie in an area over which more or less similar weather conditions exist. A study of the relationships between these conditions and ultra-short-wave propagation would therefore seem to be worth while, and, indeed, some connection has already been observed by various investigators.

In an article printed elsewhere in this issue, a contributor traces a distinct relationship between favourable conditions for long-range 5-metre transmission and the existence of a "negative temperature gradient" in the upper atmosphere. In other words, successful transmission by means of the "extended ground wave" may be expected when the temperature of the air at a height of some 3,000 ft. is higher than at ground level. The writer of the article goes on to describe the meteorological conditions likely to give rise to this abnormal temperature effect.

Usually matters of propagation are considered to be of most purely academic interest, at any rate in the early

stages of an investigation, and one is often tempted to dismiss the subject, however interesting it may be in itself, as something about which nothing can be done. In the present case, however, there is the obvious difference that, if our contributor's conclusions prove to be justified, anyone with a nodding acquaintance with meteorology stands at least a chance of forecasting the conditions likely to obtain for ultra-short-wave working—or television reception—at ranges beyond those normally expected.

Curbing Interference Establishing a Principle

ANOTHER session of Parliament is closing without any sign of the anti-interference legislation that is so urgently needed. Installation of radiating appliances is meanwhile proceeding unchecked, and, unless something is done quickly it will become quite impossible to ensure interference-free reception even to a fair proportion of broadcast listeners.

We are told that these protracted delays are due to the difficulty in reconciling conflicting interests and to assessing, on a precise quantitative basis, the nature and amount of permissible interference from various sources. *The Wireless World* has repeatedly urged the need for a stop-gap Bill to establish the general principle that, to borrow an expression from an article in this issue, those who knowingly cause interference "place themselves outside the community of the nation." The article from which we have quoted describes anti-interference methods in Germany; we do not suggest that the practices of that country should be applied here, but the fact that something can be done on quite simple lines surely contains a moral for us.

Distortionless Detection

NEGATIVE FEED-BACK AND THE DIODE

By J. E. VARRELL

ONE of the greatest difficulties in the design of high-quality apparatus is the detector circuit. The difficulties are well known. The detector should be linear and, since all known rectifiers act as square law detectors on low input amplitudes, a fairly high input is desirable. An RMS value of some 4 volts is about the best compromise between low output from the RF amplifier and high input to the detector. The detector output has a DC component on which is superimposed the desired AF signal, and if this is applied directly to an AF amplifier, the bias will vary with the signal strength. This is the case with the grid detector, and although, given the correct signal strength, the correct bias can be obtained, the large signal required for linear detection may overload the stage on a fully modulated signal. This circuit, therefore, although capable of giving good results on the correct input signal, is a compromise between high level detection and low input voltage to the triode.

If a separate diode, with a blocking condenser C₁ and resistance R₁ (Fig. 1), are introduced, the above disadvantages are avoided. However, non-linear distortion is now caused by the low AC load (R₁ and R₂ in parallel). At all modulation depths above the ratio of AC-to-DC loads, harmonic distortion is produced. For a detector load of 0.25 megohm, and a value for R₁ of 2 megohms, this means distortion on all carriers with greater than 89 per cent. modulation. This is a tolerable performance, but the distortion does

It is well known that distortion occurs in the diode detector because the AC value of the load resistance is lower than the DC value. In this article a method of obtaining equality of the values, and so removing the distortion, by the application of negative feed-back is described.

reproduction is impossible. The AVC voltage may be obtained from a separate diode, and the IF transformer primary, in which case the distortion is greatly reduced, but not eliminated. Various methods have been introduced to reduce or eliminate distortion.

Fig. 2.—Here direct coupling to the AF stage is shown, the DC component of the detector output being compensated by feed-back.

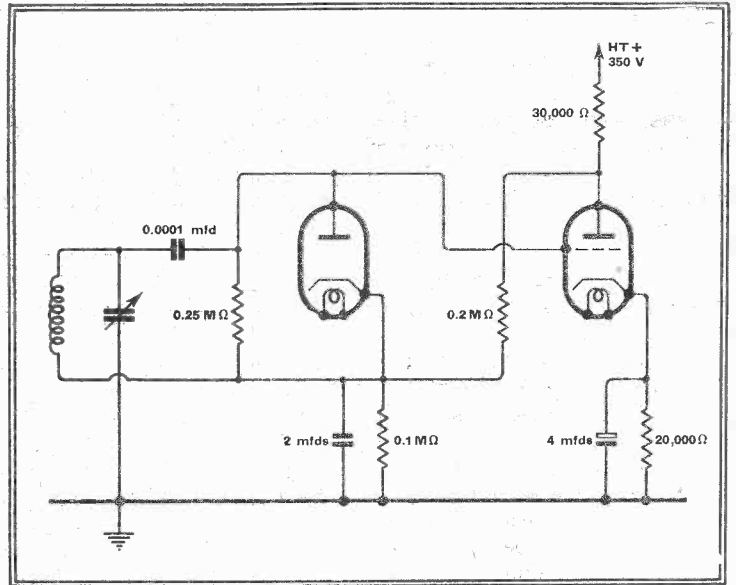

tion. AVC distortion can be eliminated by isolating the AVC circuit entirely.¹ This, however, entails an additional valve or valves, and frequently an additional HT supply. The effect of the low AC load can be largely offset by biasing the diode,² but the value of bias is critical and varies with signal strength, thus either a compromise must be made or a complex circuit evolved to give bias proportion to signal strength. The distortion caused by

local-station reception, and in the USW receiver for television sound, both of which are usually fitted with reaction. The disadvantage of the DC component being applied to the grid remains if a leaky grid detector is used.

What is required is a DC voltage equal to this DC component, that can be utilised to cancel it. Feed-back provides the solution to many of the problems in radio to-day, and will solve this one. Cathode feed-back reduces the amplification of a stage by producing a voltage across the cathode resistor proportional to the applied grid volts. The effective voltage existing between grid and cathode is thereby reduced, resulting in a decrease in amplification. If a cathode resistor is introduced, and shunted by a condenser, it produces a feed-back to any steady voltage change, but no AC feedback. The effect of a variable DC component in a diode detector output can be largely offset by this means, without affecting its AF amplification.

Fig. 1.—This diagram shows the usual arrangement of a diode detector and AF stage.

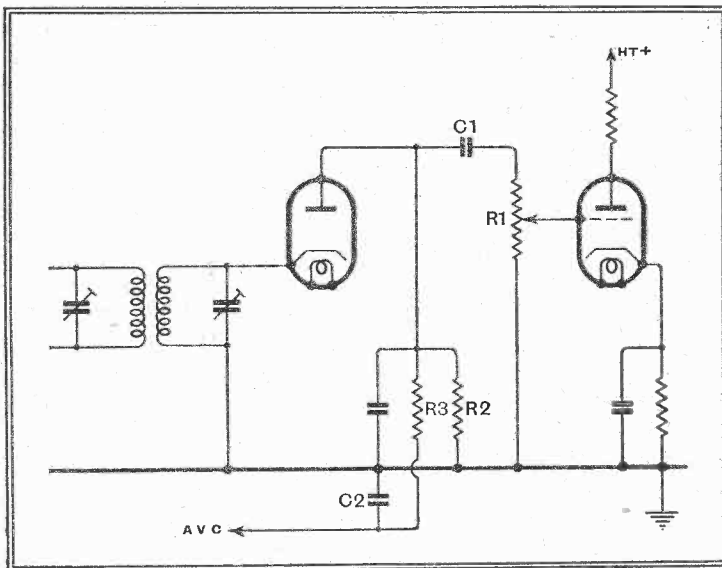

exist, and harmonic generation is the most unpleasant type of distortion. If an AVC circuit, R₃, C₂ is introduced in shunt with the diode load, the value of R₃ may be as low as 0.5 MΩ, in which case good

the shunt circuit C₁ R₁ may be eliminated by using the negative feed-back de-

¹ The Wireless World, June 12th, 1936.
² The Wireless World, March 9th, 1939.

³ The Wireless World, Jan. 1st, 1937.

Distortionless Detection—

flowing through the valve gives a potential across the cathode resistance. The operating point of the valve on its characteristic will be a point of equilibrium between current, volts across the valve, and grid-to-cathode voltage. If the grid volts decrease, due to a signal, a very small change in valve current will result in a large change of voltage across the cathode resistance. Thus the operating point of the valve is only slightly altered.

The effect can be increased by obtaining the steady voltage from the valve anode (see Fig. 2). Thus a decreasing grid voltage results in a decrease in current, which gives rise to a decrease in cathode potential and an increase in anode potential, which in turn increases the DC volts in series with the grid. The action is self-compensating, and a large increase in signal strength results in only a small change in grid-to-cathode potential. The resistance values can be calculated from the valve curves for any given operating bias, and the values given are for a medium impedance triode of mutual conductance 3.5 mA/V, and anode AC resistance 11,500Ω, using an HT source of 350 volts.

The curve of Fig. 3 shows the change in steady grid-to-cathode potential for a series of signal strength values. A change of as much as 10 volts in the value of DC component of the rectified output only moves the grid operating point approximately 0.5 volt. Since such a value is larger than ever required, because its AF component would overload the stage, the changes experienced in practice are negligible. If no reaction is required a potentiometer may be used as the diode load to form a volume control. If reaction is desired an RF choke and condenser in the valve anode circuit can be provided.

Equalising the Diode Loads

When the detector output is too large the load can be tapped, since a volume control would affect the reaction. The coil is unearthed, but, since it is at a steady RF potential, the tuning condenser may be earthed (if so, the condenser from diode cathode to earth should be non-inductive).

The applications of this circuit are limited, but it will be found useful in

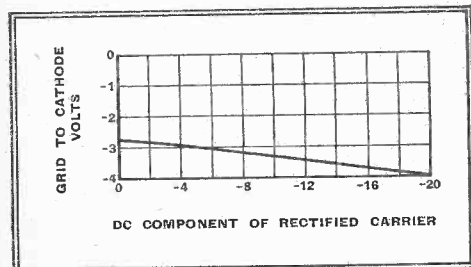

Fig. 3.—This curve shows the amount of compensation obtainable with the circuit of Fig. 2.

certain high-fidelity feeders where AVC is not required. The second circuit to be described is intended to prevent distortion

when AVC is taken from the same diode as the signal. As already pointed out, the cause of this distortion is that the AC load to the diode is lower in value than the DC load. The AVC shunt circuit is between

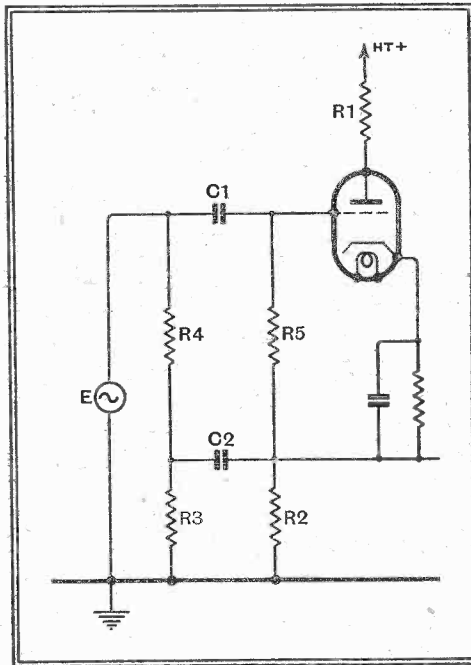
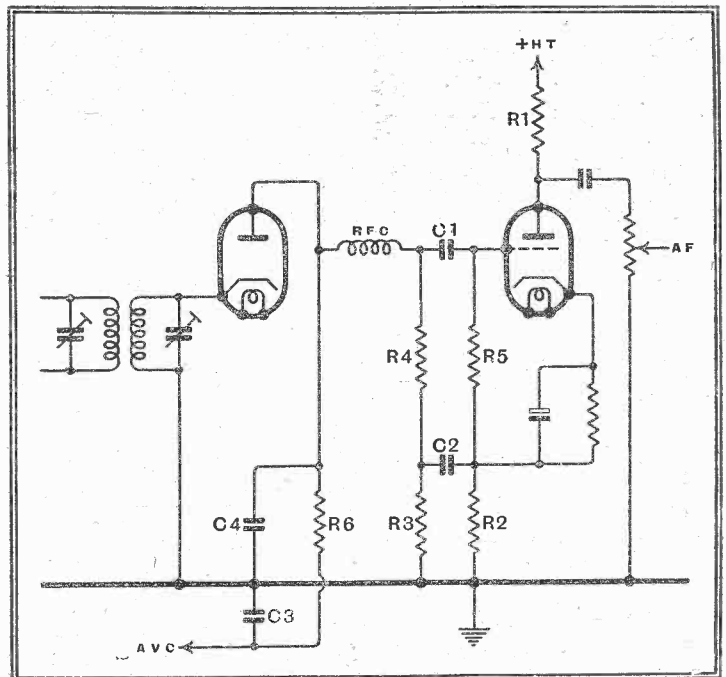

Fig. 4.—This diagram illustrates the basic circuit of the negative feedback system adopted for equalising the AC and DC load resistances.

the diode anode and earth, and its value is in shunt with the DC load. The only method by which its effect can be nullified is by making the normal AC load to the diode equal to or greater than its DC load.

A choke is the most obvious solution, but a little consideration will show the difficulty of this method. It is in the lower register that full modulation occurs, and if the AC load is to be greater than the DC, the choke impedance

Fig. 5.—A practical distortionless diode detector is shown here. The price that must be paid for the equality of AC and DC loads is lower AF stage gain.



must be about 0.5 MΩ at 50 c/s. A choke of about 1,600 H is required. However, feedback again provides the solution.

Consider the circuit of Fig. 4. An alternating voltage E is applied to the grid of the valve via the blocking condenser C1, and leak R5. The alternating current component through R2 thus caused produces a voltage across R2 in phase with E. This reduces the grid-to-cathode voltage, and thus the amplification of the

stage. It also alters the potential across R5, the grid resistance. The effect, as far as the source E is concerned, is equivalent to increasing the value of R5, because the current flowing through it has been reduced.

If a condenser C2 and resistance R3 are shunted across the cathode, the AC component of the cathode voltage is obtained, and the apparent value of R4 will be increased. If R4 and R5 are very much greater than R2, and the value of R2 and R3 in parallel $\left(\frac{R_2.R_3}{R_2+R_3}\right)$ be called Rk, the effective values of R4 and R5 are increased by a factor approximately equal to

$$I - \frac{Rk.g_m}{I + Rk.g_m + \frac{R1+Rk}{R_a}}$$

where R_a and g_m are the valve's anode AC resistance and mutual conductance respectively.

A little consideration will show that a high apparent AC resistance can be obtained, and the DC resistance remains at a value of R3 + R4. The practical circuit is given in Fig. 5. If the values given to the resistances are R1 = 30,000Ω, R2 = 5,000Ω, R3 = 10,000Ω, R4 = 200,000Ω, R5 = 0.5 MΩ, the value of Rk is 3,333Ω; and a valve of g_m = 3 mA/V, and R_a = 10,000Ω is used. For the purpose of calculating AC resistance, R4 and R5 may be considered in parallel, i.e., 143,000Ω. The AC value of the diode

load, calculated from the formula given, will be $\frac{43}{3}$ times this value, that is, 473,000Ω. The DC load is 210,000Ω, and in spite of the parallel path of C1 and R5, an AC resistance well in excess of the DC value is obtained. Distortion will start when the AC load becomes less than the DC load, and an AVC bias circuit R6, C3 can be introduced in parallel with the existing load such that the AC load is reduced.

Distortionless Detection—

The lowest permissible value of R6 to general distortion is that value required to make the AC load equal to 210,000Ω. This value is 378,000Ω, and hence the AVC circuit should be designed to provide a load on the detector circuit of not less than 378,000Ω. Since there is no disadvan-

positive potential instead of to earth. This positive potential, obtained from any convenient cathode circuit and suitably decoupled, should be in magnitude equal to the delay required. The diode D2 then shunts the condenser C3 and maintains the AVC line at earth potential until the detector DC output exceeds the delay. This

addressed envelope should be sent to Col. H. Ashley Scarlett, D.S.O., 60, Pattison Road, Hampstead, London, N.W.2.

Henry Farrad's

PROBLEM CORNER

No. 31.—Tone Control Causes Distortion

An extract from Henry Farrad's correspondence, published to give readers an opportunity of testing their own powers of deduction:—

100, Quality Street,
Raisley.

Dear Mr. Farrad,

I have a loud speaker giving very good response up to 8,000 cycles or more; and to make the most of it I am adopting the principle of tone correction, compensating for the selectivity of the receiver by raising the amplification of the upper frequencies. Fortunately, we are not much troubled by heterodyne whistles here.

The enclosed circuit diagram will show you how I have arranged it. The output valve is of the 6L6 class, which was running quite normally and successfully until tone correction was introduced, which I did by substituting a 0.25-henry coil and 2,500

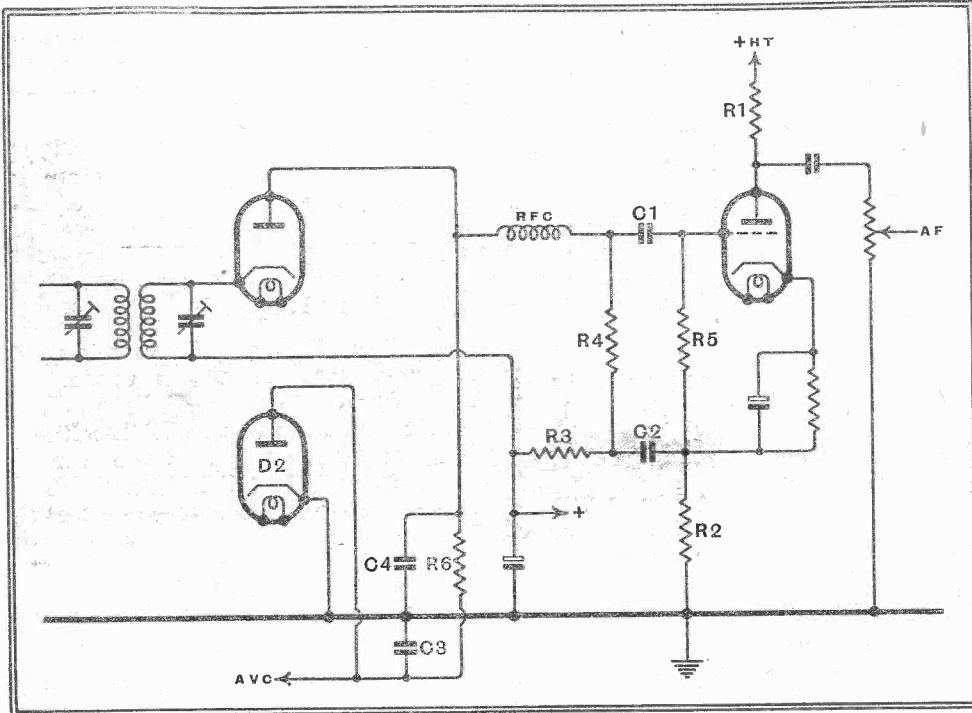

Fig. 6.—This diagram illustrates the method of obtaining delayed AVC. An additional diode D2 is used.

tage in an AC load a little higher in value than the DC load, values of 0.5 MΩ for R6 and 0.1 μF for C3 are suggested. Under these conditions the circuit will provide distortionless detection on carriers up to nearly 100 per cent. modulation. The small unavoidable distortion on 100 per cent. modulation which remains is due to the reservoir condenser C4, and the curve at the bottom end of the diode characteristic. This latter distortion is largely reduced if the AC load is greater than the DC (as in the example worked out), because the effect is equivalent to a reduction in modulation depth, and the point of curvature is avoided by the carrier envelope. Two points must be borne in mind when using this circuit. One is the reduction in stage gain. The amplification is reduced to a value of approximately

$$\frac{R_1 g_m}{1 + R_k g_m + \frac{R_1 + R_k}{R_a}}$$

in the example given, from a gain of 22.5 times to a gain of 6.3. The other is that the volume control, usually inserted after the diode, must be placed in the anode circuit of the AF stage. This is no disadvantage since the cathode feed-back prevents the stage from overloading on the largest fully modulated carrier likely to be received in practice.

If delayed AVC is required, the circuit should be modified to that in Fig. 6. The diode circuit is returned to a point of

circuit causes distortion until the diode D2 becomes non-conducting due to the bias produced on the detector diode.⁴ This, however, produces a muting action which in some cases is desirable, and for signals on which the AVC becomes effective the circuit is distortionless.

⁴ *The Wireless World*, May 13th, 1939.

Index and Binding Case

The index for Volume XLIV of *The Wireless World*, January to June, 1939, is now available from the Publishers, Dorset House, Stamford Street, London, S.E.1., price 4d., post free, or with binding case price 3s. 1d., post free.

FIVE-METRE COMPETITION

THIS annual event, organised by the Golders Green and Hendon Radio Scientific Society, will be held on September 17th next, not September 10th, as previously notified.

Eight positions in the country about Watford, Berkhamsted and St. Albans will be selected, and each receiving group visits them in rotation. The transmitter, operating under the call sign G5CDP, will send out eight different code words at suitable times, marks being awarded according to the number of code words correctly received.

The second part of the competition is to locate the transmitter by direction finding. For particulars of entry a stamped and

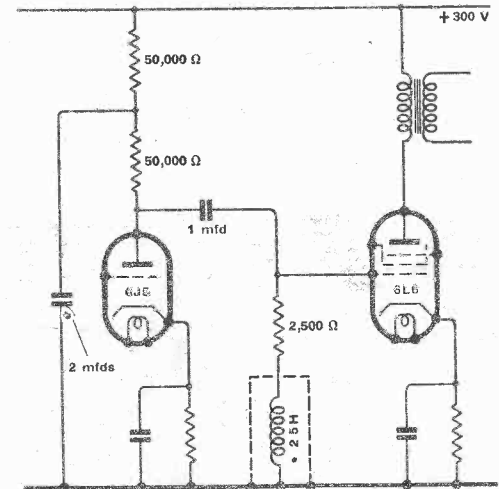

How Mark Linyer arranged his tone-control circuit.

ohms (including the resistance of the coil) for the grid leak, at the same time increasing the capacity of the coupling condenser. The valve in the tone-control stage is a 6J5. At low frequencies the impedance of the 0.25-henry coil is negligible, so the coupling is practically the resistance only; but at 8,000 cycles it is about 12,500 ohm., giving approximately a threefold increase in amplification. This seems to be about right to compensate for the loss in the RF tuning circuits, and the balance of tone is quite good; but the quality is very poor indeed if the volume is turned up.

I have checked the components, connections and the currents and voltages; and everything seems O.K. Can you help me to trace the cause of the distortion?

Yours sincerely,
Mark Linyer.

Can you? Henry Farrad's solution is on page 104.

Totalitarian Suppression

ANTI-INTERFERENCE METHODS IN GERMANY

IN spite of the fact that a definite law against man-made interference of radio reception does not, as yet, exist in Germany, there have been few difficulties in dealing with the problem. If a German should interfere with the radio reception of his neighbours by operating apparatus required for his own work or pleasure, and should he refuse to have the interference removed at once and at his own cost, he will be considered as "one who places himself outside the community of the nation," as the saying goes, and will be publicly declared as such.

Broadcasting, of course, occupies a special position in Germany. It is the official mouthpiece of the authorities. A new law comes into force as soon as it has been broadcast. A change of government policy may be announced any moment by a speech in the broadcasting programmes, and will have immediate effect. For that reason the German authorities have decided that every owner of a radio listening licence must have the right of clear reception of his local station. In districts remote from a station he is entitled to the Deutschlandsender programme, and at least one Regional transmission. Apparatus which interferes with

IN Germany, those who knowingly cause interference with broadcast reception are considered to place themselves "outside the community of the nation." This article describes the working of the anti-interference service conducted by the German Post Office.

this, provided the listener's set is in order and is connected to a reasonably good aerial and earth, must be suppressed.

The process employed is simple. The complaining listener rings up the Post Office and asks for the radio department. He can also write a letter or a postcard.

A few days later the Post Office will send a man in uniform to investigate on the spot. This expert first gives the receiver a thorough examination and then investigates the aerial, earth and mains connection. If all seems in order he next enquires about the nature of the interference heard, and then attempts to trace it.

He will even come back a second day with special searching apparatus at the reported time of occurrence of the interference which has been observed by the listener. In the event of failure to trace the source of interferences, householders in the vicinity of the complainants' residence are circulated with leaflets explaining the nature of man-made interference. This leaflet also contains a list of possible sources of interference which might be in use in an ordinary household: hair-dryers, thermostatically controlled elec-

A Post Office engineer investigating the radiation of interference from a Berlin dentist's apparatus.

By Our Berlin Correspondent

tric irons, vacuum cleaners, coffee-mills, etc. If one of the neighbouring householders suspects that he may be using interfering apparatus, he can either test it himself or call upon the Post Office ser-

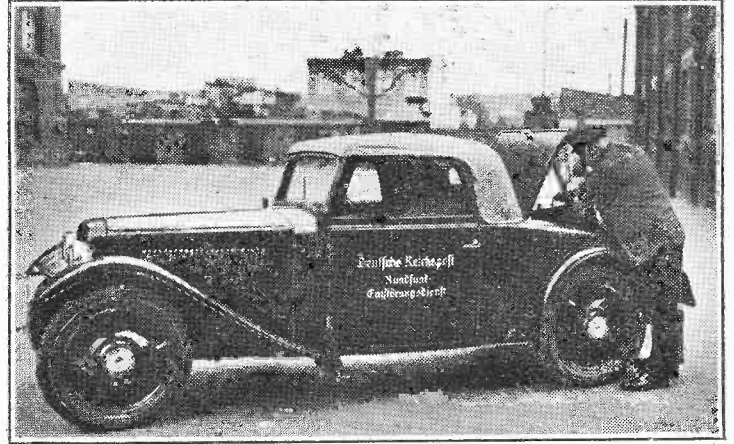

One of the German Post Office anti-interference cars, of which 250 are at work daily in various parts of the country.

vice. The Post Office then passes him on to a radio dealer, who does the job of suppressing the appliance.

Electricity supply companies, railways and large factories frequently cause interference with reception in certain districts. Here again the Post Office's anti-interference department is a great help. It energetically organises the immediate suppression of the trouble. Should this prove difficult from a technical point of view, the Post Office Research Institute is called in for consultation. Once the appropriate methods have been decided upon, a specialist firm completes the job. The Post Office consultation service is free of charge.

Growth of the Service

Before this service was taken over by the Post Office the amateur radio clubs and the broadcasting companies used to operate a similar service. But with the growing number of listeners in out-of-the-way places it was found that the investigators spent too much of their time in travelling. The Post Office, on the other hand, already had a complete, nation-wide network covering the whole country, and on October 1st, 1932, it took over the task. In the first five years of operation the total number of complaints received numbered 1,160,000. All of these were dealt with, and 700,000 sources of interference were eliminated.

During the last quarter of 1937 the Post Office investigated 66,170 complaints, and the anti-interference department's records show that these were due to the causes given in the table overleaf.

For purposes of interference suppression Germany is sub-divided into 1,000

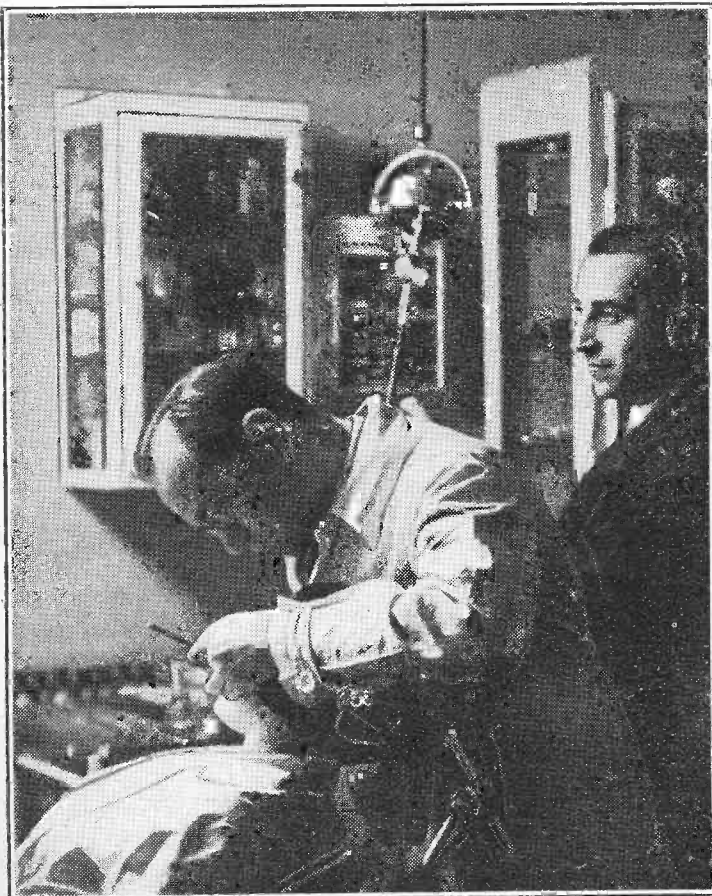

Totalitarian Suppression—

postal districts, each with a central depot fully equipped to deal with even the most difficult cases. A staff of 3,400 specially trained "searchers" is employed, and there is a fleet of cars numbering 250 in daily use.



Hair dryers, widely used in Germany, were responsible for much interference until most of the larger manufacturers began to fit suppressors.

During the past few years it has been possible to reduce the interference by high-frequency medical apparatus quite considerably. In cases where interference elimination would become too costly or would prove to be technically impossible, the doctors and hospitals are asked to work at special times, and especially to refrain from operating at the times of the news broadcasts and of the main evening programme.

Co-operation of the electrical industry has been obtained by the Post Office, and already a number of household apparatus such as have already been mentioned in this article are supplied to the public complete with interference suppressors without extra charge. In other cases an extra charge of 5 per cent. is made for "suppressed" apparatus.

	Per cent.
Faulty receivers	32
Small electric motors for domestic and small-scale industrial purposes	29
Atmospherics and untraced causes	15
Electric supply companies' lines and apparatus	11.5
Electric railways	4
Electrical massage apparatus	3
Improper use of reaction by neighbours	2
Medical apparatus	2
Official institutions	1.5

I have already pointed out that anti-interference is a comparatively easy matter in Germany, due to the official status of broadcasting and the various laws which protect it. Even though no anti-interference law exists, it is already an accepted principle that the owner of the interfering apparatus is liable to pay in full the cost of elimination. At some future

time this will, no doubt, become law. The co-operation of the electrical manufacturers is very valuable, and it is hoped that not only the biggest but also the medium and smaller firms will join in the habit of supplying apparatus that does not cause interference with broadcast reception.

My own practical experience of listening in Germany shows that conditions in Berlin are certainly much better than in London. Of course, London is bigger, but it seems scandalous that its inhabitants cannot all expect to be able to receive the local stations without serious man-made interference.

Five-metre DX

Good Results with Portable Equipment

OWING to a short vacation, the writer has no personal observations to record this week, but several interesting reports are to hand. G6XM, at Farnborough, Hants, submits a list of 41 stations heard and worked on 56 Mc/s from June 14th to July 12th. Included in this list are three Italian stations, I1FA (heard on two occasions), I1SS and I1BE, and one French station, F8AA, in Boulogne. Of the remainder, G2BI, in Colne, Wiltshire, and G6CW, in Nottingham, share honours as DX signals.

G6XM was active during the 56-Mc/s Field Day and made contact with eleven

different stations, of which five were portables. An interesting point concerning this report is that all signals were received on a two-valve det.-AF straight set.

Using a close-spaced rotary beam consisting of a director, radiator and reflector, G2QY operated a portable station from near Elstree during the 56-Mc/s Field Day, and with 10 watts input contacted G5TX, in the Isle of Wight, at 83 miles. This station was heard also by G6CW, in Nottingham, at 100 miles.

Given a favourable situation it seems that surprisingly good results can be obtained with a low-power transmitter and a well-designed aerial system.

In contrast to this is the unfortunate location of G5MP, in Hythe, Kent, who in a report states that during the early part of June, when the five-metre band was "open" for DX, while harmonics of commercial stations IBE, IRJ and IRX were received at great strength, no amateur stations could be heard on the five-metre band. Despite this, G5MP later received a card from an Italian amateur reporting reception of his signals at strength S9. Two other stations, G6DH and G5MQ, were apparently also heard on this occasion by the same Italian amateur. Apparently hills immediately north of G5MP preclude hearing any five-metre stations but those just along the coast.

Reception from the south is good, as this station reports hearing several Italian amateurs on June 24th and 25th last. These signals were audible only for very short periods and the early afternoon seems to be the best time, for G5MP reports reception at 3 p.m. G.M.T., whilst it will be recalled it was at about the same time that G6YL, in Northumberland, reported reception of Italian stations on June 25th last. Italian signals have, however, been heard and stations contacted at times as late as 8 to 9 p.m. G.M.T.

Incidentally, G6YL is only 38 miles from the Scottish Border and informs us that the distance to I1IRA is about 1,060 miles. Since Italian amateurs are not listed in any call book we could only give the minimum possible distance in these notes in *The Wireless World* of July 20th last.

Another long-distance Continental station heard in this country on five metres recently is CS3VA, in Lisbon, reception being reported via G6YL by both G5AX and G5CM at 1,170 and 980 miles respectively. No time is stated, but the date was July 19th.

CS3VA was again heard on July 24th, calling G6YL, at which station the tone-modulated signals were R5 at 5 p.m. G.M.T. and remained audible until 6 p.m. G6DH reports hearing this station also at exceptional strength. G2MC.

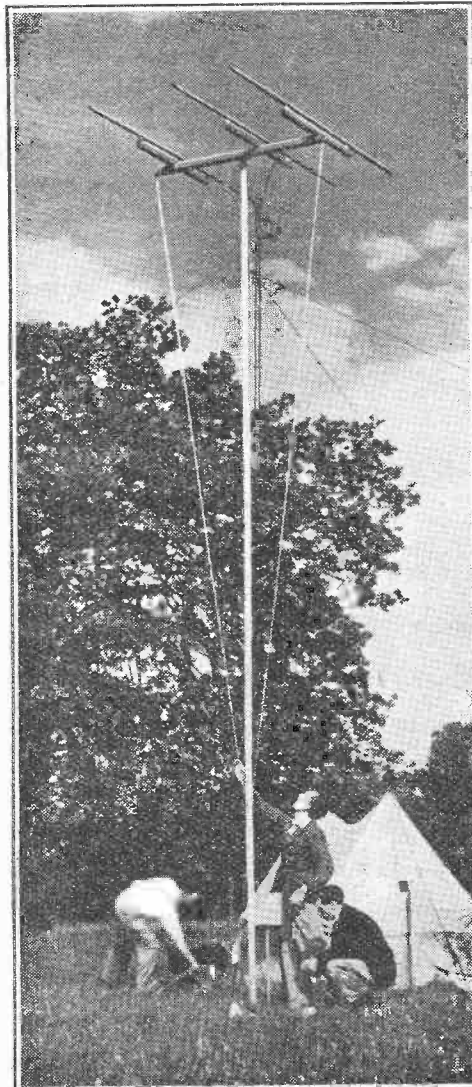

Portable station erected by G2QY for the recent 56-Mc/s field day. The aerial is a close-spaced rotary beam with open-wire transmission line to the radiator (centre element).

High-voltage Problems.—I.

By M. G. SCROGGIE, B.Sc., A.M.I.E.E.

Danger—High Voltage!

WHAT LIES BEHIND THIS WARNING

THE exact number of television receivers in use in this country is not known, but 20,000 is perhaps not an excessive estimate. One does not have to be wildly optimistic to foresee 100,000 in the next year or two, and the number may ultimately be much greater still. The voltage required in present-day televisions is 4,000 to 6,000, but already some are being run at 25,000. Although the general public need not know anything about this, those who design and handle television receivers and their components, those who test and service them, and those who make them at

THANKS to increasing interest in television, and, to a lesser extent, in amateur transmission, a greater number of readers than hitherto must sooner or later become acquainted with higher voltages than those existing in normal receiving apparatus. Now high voltage is not merely "the same as before, only more so," and so arrangements have been made to publish a short series of articles dealing with the various phenomena and effects particularly associated with it.

non-engineering readers, is the number of times the working stress has to be multiplied in order to cause breakdown. For example, it may be found that 10,000 volts is necessary to break down a certain type of condenser. If it is actually used for 10,000 volts, that is to say, with a factor of safety of 1, it is on the very edge of breakdown and is practically certain to fail sooner or later. Bearing in mind that a condenser is liable to deteriorate if worked near the breakdown voltage, that the 10,000 volts may be subject to occasional momentary higher peaks, and that unfavourable climatic conditions may

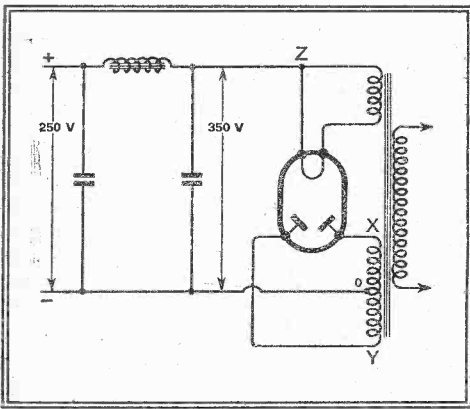

Fig. 1.

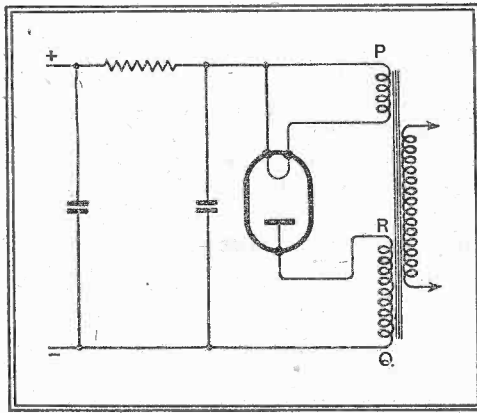

Fig. 2.

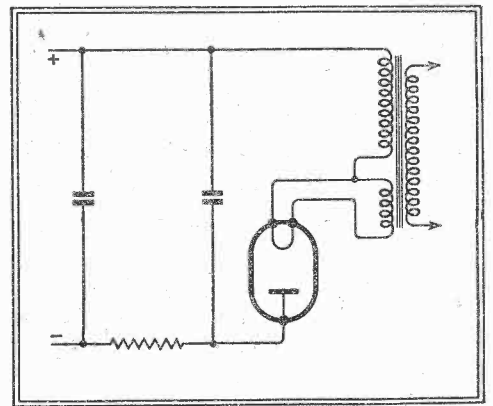

Fig. 3.

The familiar rectifier circuit used for supplying valves involves a peak voltage across the transformer as high as 4 times the DC voltage delivered, so is not favoured for high voltage systems. The half-wave circuit, Fig. 2, which brings the maximum potential inside the transformer. In the voltage doubler circuit, the transformer voltage is still further reduced.

home, must sooner or later get used to dealing with voltages at least ten times greater than they have been accustomed to. Then circumstances have caused the authorities to reverse their attitude towards amateur transmitting, and actually encourage people to familiarise themselves with the use of transmitting apparatus, which generally involves fairly high voltages. Even public address gear sometimes comes within this description.

It may be said that this tendency involves only a change in degree, not in kind; just the same thing as before, only more so. But that argument may be difficult to sustain when a person who used to get mere shocks on 500 volts is killed by 5,000. Moreover, there are some effects produced by thousands of volts that are not even slightly present at hundreds—such things as corona, which sets in quite suddenly at a critical voltage. People beginning to deal with high voltages are asking for trouble—apparatus breakdown or personal injury—if they do not allow an ample factor of safety. The death of an American amateur recently was due simply to a failure of the insulation between two

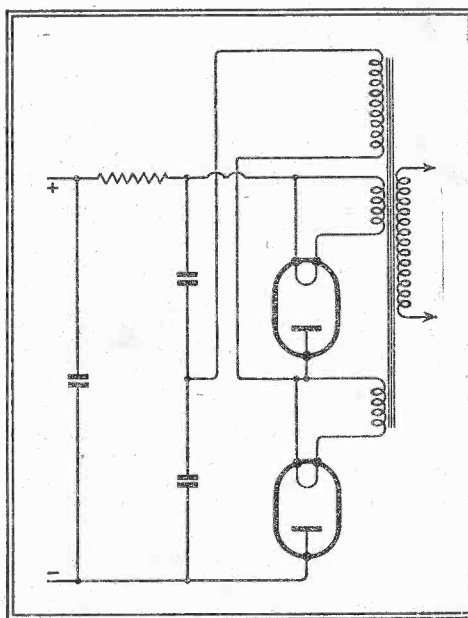

Fig. 4.

windings of a transformer. The question is, what is ample without being extravagant?

Factor of safety, for the information of

occur, it is prudent to use a condenser requiring two or even three or more times the working voltage to break it down. The factor of safety is then two or three respectively.

It must be remembered that although the voltage applied to a television tube is, say, 5,000, it is not the highest voltage in the receiver. The type of power unit used in most sound receivers is connected as in Fig. 1, and gives an output of 250 volts DC. But 100 volts may be dropped in the smoothing choke (loud speaker field), making 350 across the reservoir condenser, with ripple peak values going up to perhaps 450. This requires 350 volts RMS, and in this full-wave circuit there is a winding each side of the centre tap, making 700 RMS between X and Y, or practically 1,000 volts peak. For cathode-ray tube power this circuit is avoided, and because of the small current to be supplied a simple half-wave circuit with resistance smoothing is adequate (Fig. 2). The voltage across PQ is, say, 6,000 DC, but as the point R is alternating between about +6,000 and -6,000, the voltage between PR alternates between nearly zero and 12,000. To keep such an

Danger—High Voltage!

The uncomfortable voltage out of the transformer the rectifier can be reversed (Fig. 3) so that interwinding insulation for 12,000 volts is not needed. Only the rectifier and the leads to it are called upon to stand this tension. The transformer voltage can be almost halved by using a voltage-doubler circuit (Fig. 4); but whatever scheme is used, the peak voltage across the rectifier during the non-conducting half-cycle is approximately double the peak voltage of the transformer winding feeding it, and therefore 2.8 times the RMS voltage of that winding.

Electrical Stresses

What exactly is a breakdown due to voltage? The minute details of what happens in this event still give scientists material for research and discussion; but in general respects the mechanical analogy of applying a stress—tension or compression—to a piece of material till it breaks is quite a fair one. Of course, no engineer loads his structures close to the breaking point. But however small the stress—lb. weight or volts as the case may be—there is a certain amount of strain, which as an engineering term has a different meaning to the common one. It means the resulting sag, bend, stretch, etc. The electrical equivalent is the charge. When a difference of voltage, or potential, is applied between two conducting objects a positive charge is moved on to one and an equal negative charge on the other. The greater the

some cases and quite large in others. The amount of charge due to any given voltage is a measure of the *capacity*: Every object—even a speck of dust in space—has some capacity, but the amount is only considerable when the space between it and some other object at a different potential is relatively small, as in a condenser. The capacity of a condenser depends mainly on the dimensions, but also on the nature of the insulating material between the two oppositely charged plates. Just as rubber “gives” more than a piece of steel of the same size and shape, so mica allows a greater electrical displacement than air, other things being equal. The number of times greater is called the dielectric constant.¹ It is interesting to compare electrical and mechanical stress and strain; voltage corresponds to force or weight, which may be steady or vibratory (direct or alternating); charge (measured in coulombs—ampere-seconds) to stretch; current to rate of stretch due to applied load; resistance to friction; capacity to “stretchability.”

In diagrams or mental pictures it is helpful to imagine each unit of positive charge to be connected by a “line of force” to its negative partner. The greater the intensity of the electric field, the greater the density of these lines—that is to say, the number of them per square inch or centimetre. If in Fig. 5 (a) we suppose there is a plate 1 sq. cm. in area raised 10 volts, we might agree to represent the resulting electrical strain by 10 lines. Applying only 5 volts

the maximum electrical stress can easily be found by dividing the voltage by the closest spacing. Actually that gives the average across the space, which is the same as the maximum only when the field is quite uniform. Theoretically that is only so when the space is between two infinitely large parallel plates. Elsewhere the intensity is not uniform, so the maximum—which is what matters—must be greater than the average. In Fig. 5 we have conveniently ignored “edge effect.” Although the spacing between the edges and parts not exactly opposite is greater, so that the intensity is less, it is not zero;

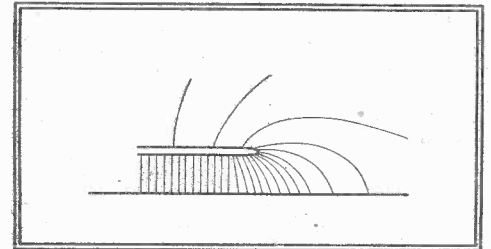

Fig. 7. Owing to the diverging field the electrical stress at sharp angles is much greater than the average.

and, therefore, there are some lines spreading out as in Fig. 6. Even the wiring and the battery itself are not exempt. In fact, if the wire is carelessly allowed to approach closely, the local intensity is very great. At sharp corners or points, as shown enlarged in Fig. 7, the density of lines is enormous actually at the point; so the field strength is very much greater than average here and much less farther along the lines. For instance, 10,000 volts across a gap of 1 cm. is a field of 10,000 V/cm. between infinite parallel plates, but between a point and a plate it may be 100,000 volts per cm., or even more, close to the point.

What may have seemed an irrelevant theoretical discussion is now, literally, coming to the point. Air under normal atmospheric conditions will stand up to about 30,000 volts per cm. If there is a difference of potential of 7,500 volts between two parts in a television receiver, it might be supposed that 0.5 cm. spacing would be allowing a factor of safety of 2, the intensity being only 15,000 volts per cm. But as we have seen, the local intensity might easily be above the breakdown limit.

Why Insulators Fail

We have not yet considered what electrical breakdown actually is. Air is normally a very good insulator, in spite of the fact that largely owing to ultra-violet light and other radiation there is a certain amount of ionisation that causes a slight leakage. As the electrical stress is increased, these ions are attracted or repelled more violently; and at a certain speed they begin to knock electrons out of molecules of the air gases, producing more ions. These in turn are available for producing more, until a strongly ionised—and therefore conducting—path is

Diagrams explaining the meaning of electrical stress or field intensity.

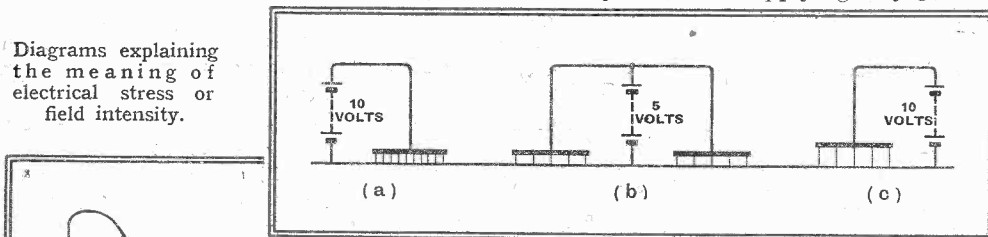

Fig. 5

to the same plate (b) there are, of course, five lines. If a second similar plate is connected the area is doubled and the total number of lines brought up to 10, but, of course, the number of lines per sq. cm. is as before. Restoring the voltage to 10, and doubling the spacing, the capacity or charge per volt is halved (c). So as the density of the lines is only half what it was in (a), in spite of the voltage being the same, it is clear that what has just been called the “intensity of the electric field” is not just volts. If it is reckoned in volts per cm. spacing, however, it works out all right, because the spacing being doubled one would have to double the volts to keep the density of lines the same as before. This is quite in agreement with our mechanical analogy, because it is not the total load in lb. that must be taken into consideration in deciding what is safe, but the intensity in lb. per sq. in. of the material.

One might jump to the conclusion that

¹ More correctly it is with reference to a vacuum: but air is almost the same.

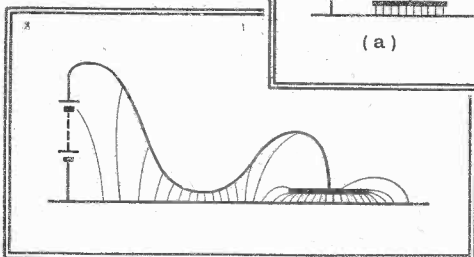

Fig. 6

voltage, the greater the charge; and normally these two are proportional to one another, just as is expressed in the mechanical equivalent by Hooke's Law—strain is proportional to stress. But in both cases the law holds good only so far; beyond that there are irregularities which finally lead to breakdown—the point where no stress at all can be maintained. The mechanical piece breaks and lets the weight go; the space between the charged objects breaks down and lets the electricity across the short-circuit between the two.

If you lay a penny on a span of the Forth Bridge, the strain is not noticeable. But if you lay it on a bridge made of a thin steel rule the strain is easily visible. Similarly the charge due to a certain voltage may be too small to be measured in

Danger—High Voltage !

forced through the region of greatest stress, narrowing the gap and increasing the stress farther on ; until finally a spark jumps across the whole gap, and the heat produced causes the ionisation to be so intense as to constitute a short-circuit. The effects on the other insulating materials will no doubt be discussed in a later article, but the general result is the same, except that it may be permanent instead of self-healing when the stress is removed.

Under some conditions, especially with points or very thin wires, there is an intermediate stage in which the air is not absolutely broken down but there is a considerable discharge, accompanied by a bluish glow, a rustling noise, and a smell of ozone. This is called corona (or brush discharge), and apart from the loss of power is a dangerous condition because it is liable to be the forerunner of a flash-over. The ozone also provokes deterioration of some materials.

Fig. 8, from information given in F. W. Peek's *Dielectric Phenomena in High-Voltage Engineering*, shows the minimum peak voltages that spark across air gaps. It is seen that owing to the more uniform stress a higher voltage is needed to spark across a given gap when small spherical electrodes are used in place of points, and still more for spheres so large as to form almost parallel plates. The graph also shows the experimental fact that very small gaps—1 mm. and less—are abnormally strong in proportion to their length due to the reduced scope for ionisation by collision.

When the pressure of air or other gas is reduced it is electrically weaker ; as in neon tubes, where moderately high voltages pass currents through very long spaces.

If the electrodes are wet, or roughened, corona starts at consider a b l y lower voltages. There are other circumstances that tend to increase the risk, so the spacings

Fig. 8. Maximum sparking distances with different voltages and types of electrode.

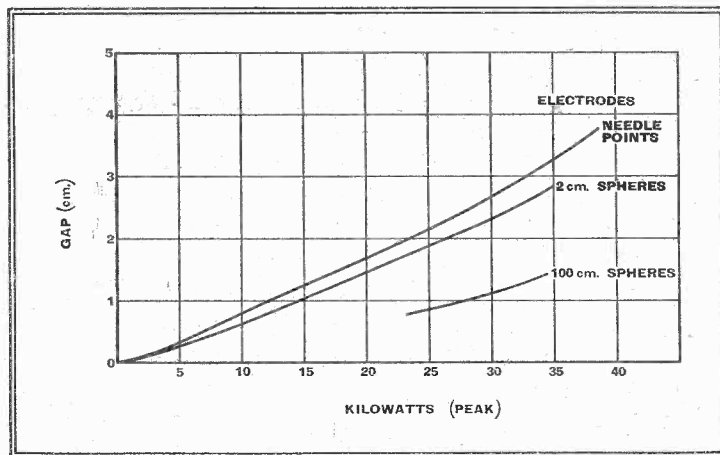

shown in Fig. 8 should be multiplied several times for safety. Particularly avoid such things as loose strands of flex projecting around terminals.

Sometimes a space is filled partly with air and partly with some insulating material having a higher dielectric constant. Although this material may itself be stronger electrically than air, the effect of the high dielectric constant is a lower electrical stress across the part of the space occupied by it, throwing the main burden on the air, which may then break down and transfer the entire stress to the

solid insulation, breaking it down. Composite insulation is therefore liable to be weak. An exception is the use of high di-electric constant material as the innermost layer round a thin high-voltage cable, to lessen the local electrical intensity. But care should be taken in using condensers in series for high voltages. Suppose a 0.5 mfd. condenser is needed to stand 5,000 volts, and only 2,500-volt condensers are available. It need hardly be said that if two of these are connected in series they must be of equal capacity, 1 mfd. each. Even so, the risk is somewhat greater than with a single 5,000-volt condenser ; and, if the circuit permits, it is wise to shunt each condenser by an equal resistance, in order to equalise the stresses imposed.

Cumulative Deterioration

In air, it matters little whether the electrical stress is steady, low frequency, or high frequency, if the peak voltage is the same. The only exception is with momentary surges ; if the peak is over within a few microseconds, it is possible for it to rise considerably above the normal breakdown voltage ; then if it sparks at all it may do so when the voltage has fallen well below the peak or even below the normal sparking voltage, like a sort of delayed retribution. Solid insulation, as in condensers, is more affected by the time it is subjected to stress. A condenser that stands 5,000 volts for a second or less is liable to be broken down by perhaps 4,000 volts DC continuously, or 2,500 volts peak AC. This is because of cumulative deterioration ; and the reason an alternating voltage is so much worse is that the charge continually flowing in and

at 2,000 volts and therefore appeared to be as safe as could be desired, large numbers broke down in service on this continuously pulsating voltage of about 600 peak, with possibly occasional surges.

Considering personal risks now ; one often hears it said that such and such a source is very high voltage "but hasn't much current behind it." This may be rather a puzzling statement in the light of Ohm's Law, according to which the greater the voltage applied to a given resistance the greater the current. Whether everybody who uses the expression has a clear idea of what they mean by it is uncertain, but there are two possible explanations. The voltage produced by a small spark coil may be capable of sparking across half an inch in air so that according to Fig. 8 it is at least 15,000. But it is capable of giving no more than a smart shock if the terminals are touched by the hands, whereas with the same voltage from a television power unit across the first reservoir condenser the odds would be heavily in favour of a fatality. The reason for this is that the internal impedance of the small coil is so large that, when the comparatively low resistance of the human body is connected, the voltage actually across the latter, and hence the current, drops to a harmless level. Similarly one may emerge alive from a shock taken across the cathode-ray tube itself, if there is a high smoothing resistance in series to limit the current.

The explanation that covers other cases depends on the fact that a certain quantity of electricity is necessary to inflict death or any other injury. Quantity is current multiplied by time. A current that would infallibly be fatal if prolonged can be tolerated if it is sufficiently brief. It would be safe to discharge through oneself a 0.01 mfd. condenser charged to 20,000 volts, whereas 10 mfd. charged to 10,000 volts certainly would not. As "Free Grid" has complained, the stroking of cats sometimes generates voltages high enough to produce visible sparks without punishing the stroker ; the capacity is too small.

Reservoir condensers charged to several thousands of volts are likely to be dangerous, even long after the power has been switched off ; so before working on the apparatus one should discharge them. The method of doing so by short-circuiting the terminals with a stout screwdriver is not the right one, however ; because if the voltage is, say, 6,000 and the total resistance less than an ohm, the momentary current is over 6,000 amps, and may be enough to weld the screwdriver to the terminals, and perhaps permanently damage the condenser internally. A resistance of about 10,000 ohms bridging wire prongs held at the end of an insulating rod is a safe method. An interesting comparison is a lightning flash, which can pass such an enormous current as 100,000 amps at many millions of volts, with disastrous effects ; yet the same charge could be dissipated with no fuss or noise, at the very non-celestial rate of a few milliamps, if spread over a few minutes.

out constitutes an alternating current which tends to heat the condenser, reducing its defensive powers. If the electrodes are not very firmly clamped, they vibrate mechanically due to the alternating electrical attraction ; and in time that also tends to cause weakness. The effect of a sudden surge, due perhaps to switching, is then likely to finish it off. An example occurs to mind in which 0.1 mfd. buffer condensers were connected across XZ and YZ in Fig. 1, the transformer voltage being only 250-0-250. Although these condensers all stood "flash" tes:

New Apparatus Reviewed

MILLER TYPE 100-LR PICK-UP

THIS component is a very fine example of the instrument maker's art, and its design and performance are more than equal to the advances of present-day recording technique. It is produced by the Lansing Manufacturing Co., Los Angeles, California, and is obtainable in this country through British Acoustic Films, Ltd., Woodger Road, Shepherd's Bush, London, W.12. The price including royalties is £42.

The principle of operation is similar to that of the d'Arsonval moving coil galvanometer, and since the transverse magnetic field is uniform there is no possibility of amplitude distortion. The sapphire stylus is ground to an angle of 40 degrees, with a radius at the point of 0.002 inch. It is set in the apex of a duralumin conical shell, turned from the solid.

The suspension consists of a metal ribbon under a tension of 7 kilograms exerted by a

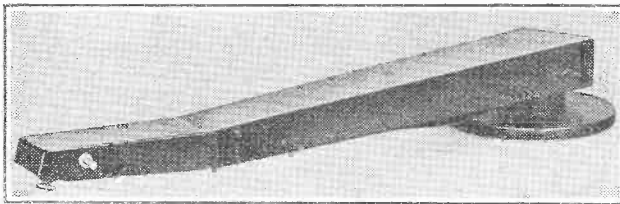

The tone arm of the Miller pick-up is balanced and adjustable for needle pressures between 6 and 30 grams.

the moving parts is 85 milligrams, or about one-quarter the weight of a steel needle.

A very light pressure is required to keep the stylus in contact with the groove wall, and the pick-up is, therefore, well suited for playing back from acetate discs, or even wax masters. The tone arm which is designed for tangential tracking has double pivots, and is fitted with a micrometer weight adjustment with a range of 6 to 30 grams.

The output impedance is 50 ohms, and

the EMF developed on an average record is of the order of 0.01 volt RMS. It will be seen from the curve taken in our laboratory, that the frequency response is a close approximation to the characteristic supplied by the makers of the test record. Correction for the drop in amplitude in the bass must be made in the amplifier. This is as it should be, for when compensation is made in the pick-up, harmonic distortion is generally present.

A NEW MIDGET TRIMMER

THE ceramic trimmer condensers made by the United Insulator Co., Ltd., 12-16, Laystall Street, London, E.C.1, are now available in a small size known as the Bijou type. They are of the same design as the standard type and have optically ground stators with a silver electrode fixed directly

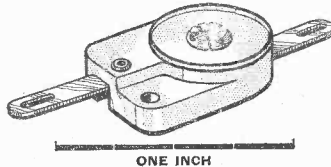

United Insulators' Bijou type ceramic trimmer.

on the surface. The length of the body is, however, less than 1/4 in.

The Bijou trimmers are available in single or double types with "Calit" stators and "Tempa S" or "Conda F" rotors. The former are made with capacity ranges of 1.5 to 5.5 and 2.0 to 8.0 micro-mfd., and the latter in three ranges of 3 to 20, 6 to 36 and 15 to 45 micro-mfd.

The Wireless Industry

ROTARY converters with AC outputs up to 250 watts are described in a leaflet obtainable from Charles F. Ward, 46, Farringdon Street, London, E.C.4. These machines can be supplied with built-in all-wave filtering and also with an extended shaft for operation as self-excited alternators.

The works of Electrical Sound and Television Patents, Ltd. (Sinclair Speakers), Pulteney Terrace, Copenhagen Street, London, W.1, will be closed for annual holidays from August 5th to 14th. The apparent change of address is the result of an alteration of street name.

The Retail Credit Finance Corporation Ltd. was established in 1929, and not as stated in the advertisement in last week's issue.

Cathode-Ray Tubes, by Manfred von Ardenne. Translated by G. S. McGregor, M.C., and R. C. Walker, B.Sc., A.M.I.E.E., A.M.I.Mech.E. Pp. 530+xiii. Published by Sir Isaac Pitman and Sons, Ltd., London. Price 42s.

THIS book is a translation of the earlier "Die Kathodenstrahlröhre und ihre Anwendung in der Schwachstromtechnik," by the same author; it is, however, more than a translation, for it has been largely rewritten and much new material has been included. It is virtually a new book, but many of the illustrations are the same.

In spite of its great length, there are only four chapters, headed "The Cathode-ray Tube," "Accessories," "The Cathode-ray Tube and Auxiliary Equipment for Making Measurements," and "The Cathode-ray Tube as an Operating Unit." Each chapter is thus almost a book in itself.

The first chapter deals with the tube itself and is concerned with the production of cathode-rays, focusing, deflection, control, and with tube construction. The second chapter covers associated apparatus such as the voltage-supply equipment, time-bases, amplifiers, and photography.

The remainder of the book is devoted to the use of the tube with the necessary accessories and the applications discussed cover an enormous range from the examination of components to sound-film recording and television. This last section is the least satisfactory, for it is the one part of the book that has not been rewritten "since the author has discussed this subject in considerable detail in the light of present-day experience in his book *Television Reception*, which was published in 1936."

The rest of the book, however, contains an enormous amount of material and there are few problems connected with the CR tube which it will not help to solve. It is well printed and bound and beautifully illustrated.

W. T. C.

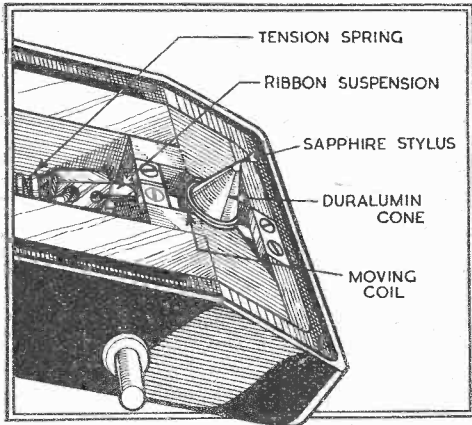

Underside of Miller pick-up head with cover removed.

coil spring inside the pick-up head. It is so adjusted that no longitudinal vibration can be excited, and resonances in a lateral direction are quite negligible when the stylus is under the control of the record groove. The needle point impedance is extremely low, and the effective mass at the stylus is only 24 milligrams. The total weight of all

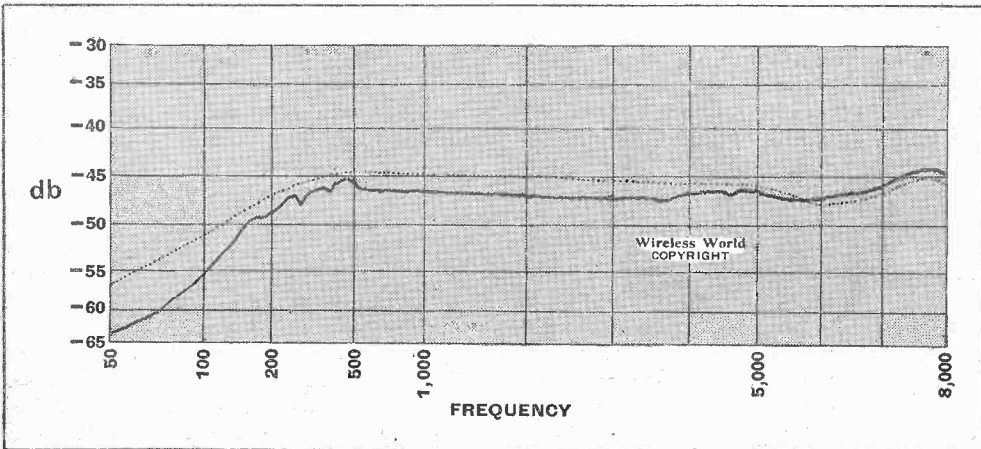

Output characteristic of the Miller 100-LR pick-up. The dotted curve represents the maker's calibration of the test record. Zero db corresponds to 1 volt R.M.S.

Five-metre Signals and the Weather

EFFECT OF UPPER AIR TEMPERATURE ON U-H-F PROPAGATION

By D. W. HEIGHTMAN (G6DH)

THOUGH the exact connection was rather obscure, it has been apparent to experimenters on 56 Mc/s that there must be some relation between weather conditions and the propagation of these frequencies, at distances in excess of the optical range. We find that on some days (and nights), even when using transmitting aerials well under 50 feet high, that signals are receivable over distances considerably greater than one hundred miles. The fact that the signals can be received at night, their high frequency, general lack of any pronounced skip and comparative steadiness rules out the possibility of bending in layers ionised by the sun's radiation. We, therefore, conclude that under certain conditions the signals are refracted in the lower atmosphere in a manner similar to light waves.

It should be mentioned that we are not here concerned with the intense E-layer bending, which on some summer days is sufficient to refract signals of over 60 Mc/s at distances between 500 and 1,000 miles. Quite probably, however, the lower atmosphere bending here described would contribute to the raising of the apparent E-layer limit by giving the stations an effectively increased height and allowing the signals to just "skim" the ionised layer.

Prior to the following observations it had been noticed that best conditions resulted when there was a sudden drop in

AFTER discussing the conditions under which long-range transmission may be effected on 5-metre wavelengths, the author traces a direct relationship between these conditions and the temperature of the upper atmosphere relative to that prevailing on the ground.

weather and 56-Mc/s conditions. For the first ten days there was a wind between east and north, giving warm sunny days and cool to cold evenings. On the 10th to 11th the wind went round to the south-west and rain came. U-H-F conditions were excellent for the first ten days, particularly in the evenings, falling off on the 10th and becoming bad on the 11th. Poor conditions prevailed until the 21st—22nd when the wind again went round to north-north-east. On the 22nd radio conditions were excellent, gradually falling off until the 25th when they became poor again, corresponding with the change of the wind to westerly and southerly directions.

It became obvious to the writer that more detailed information on weather conditions was necessary before any definite conclusions could be drawn. Copies, for the month of June, of the very comprehensive reports issued daily by the Air Ministry were therefore obtained.

From the "Upper Air Section" of these reports, which have charts showing air temperature from ground up to 24,000 feet or so, one thing immediately became apparent, i.e., that on any day extended ground-wave signals had been observed there was an inverse temperature gradient somewhere between ground level and 3,000 to 4,000ft. That is to say, whenever the air temperature between 1,000 and 4,000ft. exceeded ground temperature conditions for U-H-F propagation were good. More normally the air temperature

drops off at a fairly steady rate with increasing height. Fig. 1 gives the general form of the upper air temperature chart (a) for normal days producing poor conditions and (b) an "inversion" day giving excellent conditions.

From the data on the weather reports and the writer's 56-Mc/s log, Fig. 2 was produced. This shows the difference be-

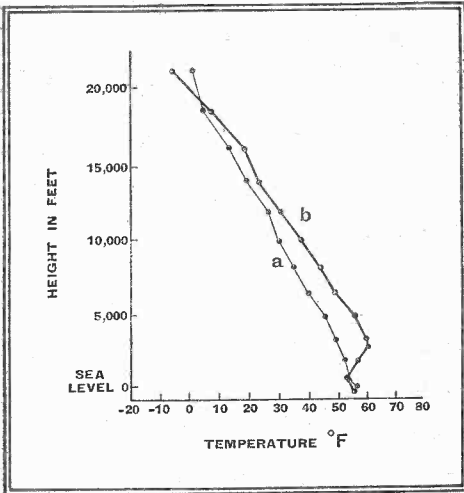

Fig. 1.—General form of upper air temperature curves for normal and "inverted" conditions.

temperature, when the wind was in a northerly to easterly direction and also during foggy weather. Poor conditions prevailed during rain at mid-day, and when the wind was warm from southerly to westerly directions.

The month of June this year provided excellent comparative conditions in

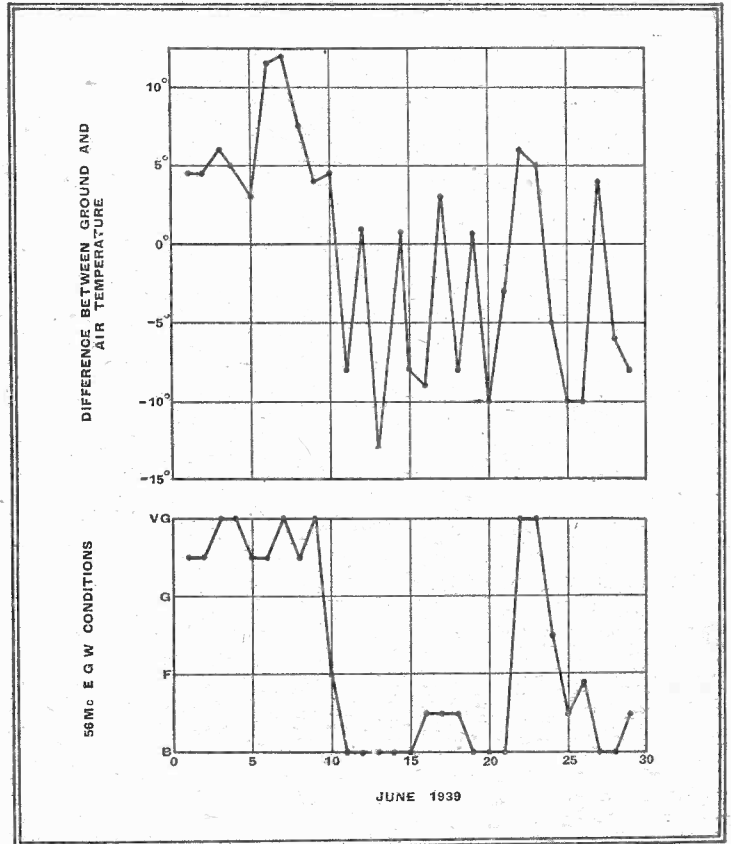

Fig. 2.—The upper curve shows differences above and below ground temperature at heights of 1,000-4,000ft. (Most observations taken at Mildenhall.) Corresponding conditions on the 5-m. band are shown in the lower curve. Abbreviations: VG, very good; G, good; F, fair; B, bad; EGW, extended ground wave.

tween the upper air temperature (1,000 to 4,000ft.) and ground temperature compared with observed conditions for the whole month. Inspection of this chart leaves little doubt as to the direct relation between air temperature and U-H-F conditions, especially if it is remembered that the weather report figures are for 6 hours GMT, while most of the radio observations were made at around 22 hours the previous night. There is, unfortunately, a lack of consistent activity on the part of 56-Mc/s experimental stations which makes the determining of conditions rather difficult.

Unfortunately the writer possesses very little knowledge of meteorology, having been in the past rather inclined to treat it as a subject to be ignored as far as radio conditions were concerned. In view of this fact it is not considered wise to discuss

Five-metre Signals and the Weather—

very fully here the weather conditions required for temperature inversion. During the last few weeks, however, quite a little has been learnt in this respect, and the B.B.C. shipping and general weather reports have taken on a new interest. It is now possible to forecast with reasonable accuracy, by simple weather observations and listening to the radio reports, as to whether or not 56-Mc/s conditions will be good on any particular evening.

Inversion of the temperature gradient, apparently, rarely takes place at mid-day and most frequently occurs in the late evening, during the night (particularly in the summer) and also during early morning. The Air Ministry reports deal with the temperatures at approximately 6 and 12 hours GMT. Taking the first ten days of June, every one of which showed inversion at 6 hours, not one had this effect at mid-day. What takes place is presumably this: During the day the sun's rays heat up the ground and consequently the lower atmosphere, this warm air tending to rise throughout the day. In the evening with a cold north-easterly wind blowing the air at ground level rapidly becomes cool and itself tends to keep low with the warmer air rising upward. This condition persists more or less until the next day when the air at ground level again becomes heated up. Obviously when the warm south-westerly winds blow the cooling effect will not take place and there will be no temperature inversion. It is also understood that during foggy weather (which gives good conditions) a layer of warm air exists over the fog layer.

Morning and Evening Conditions

Most amateur work has been done at night and hence experimental data is lacking for the early morning periods. Some daily tests made by the writer with G2OD, 83 miles distant, at 8 hours have, however, shown that conditions can be quite as good at that time as in the evenings. At the writer's station the television transmissions vary very considerably both from day to day and at different hours during the day, and it is very probable that the weather conditions also affect these signals. Meter tests are at present being made on these transmissions.

In the short time available it has not been possible to go fully into the actual mechanism of the above described propagation, but it is hoped that the matter can be dealt with more fully at a later date. Presumably the signals are refracted in the manner of light, and the condition necessary for downward bending is that they should be propagated from cold to warm air. A query that immediately arises is—what is the effect of this refraction on frequencies lower and higher than the 56 Mc/s amateur band on which observations were chiefly made? If the signals are refracted in the manner of light waves we should expect higher frequency signals to be bent to a greater extent than the 60 Mc/s ones. To obtain more data in this respect it is hoped to make some

tests on 112 and 224 Mc/s in the near future. Tests on 28 Mc/s have tended to show that signals of this frequency are not bent to as great a degree as the 56-Mc/s signals, though the tests were not very conclusive.

HENRY FARRAD'S SOLUTION

(See page 96)

THE 6L6 valve, when running normally with 300 volts on the anode, takes a grid bias of -12 volts (as can be ascertained from *The Wireless World Valve Data Supplement*), and it may therefore be assumed that the peak signal voltage for full output is nearly 12. The signal voltage given by

the previous stage is equal to the peak current variation multiplied by the coupling resistance. The latter is 2,500 ohms at medium and low frequencies; and, as the resistance between the valve and the 300 volts HT is 100,000 ohms, the former *must* be less than 3 milliamps (0.003 amp.). Irrespective of distortion, the maximum possible voltage available is therefore less than 7.5, and without bottom bend distortion is much less still, and so is quite insufficient for the full volume.

The output can be raised and the distortion reduced by increasing resistance and inductance in equal proportion; but, by the time it is enough, the increase in amplification at high frequencies is not maintained. It is evident that a large amount of amplification is needed between the tone correction and output stages.

Voigt HC Corner Horn

BASS CHAMBER FOR EXTENDING THE LOW-FREQUENCY RESPONSE

INTRODUCED originally to provide suitable loading for the Voigt loudspeaker unit at a price considerably lower than that of the full-sized corner horn, the HC horn has given excellent results down to 100 c/s, or perhaps a little lower.

To bridge the gap between the performance of these two horns, a bass chamber has now been designed for addition to the HC horn. The principle is similar to that of the big corner horn in that the radiation from the back of the diaphragm is collected and diverted through a branched conduit with outlets near the floor. It is reasonably

off having been lowered from 100 to between 45 and 50 cycles. The response in this region is best appreciated on sustained organ pedal notes, though it may be expected to increase also the realism of orchestral performances.

The modified corner horn is supplied complete in birch ply for £7 15s., and the work

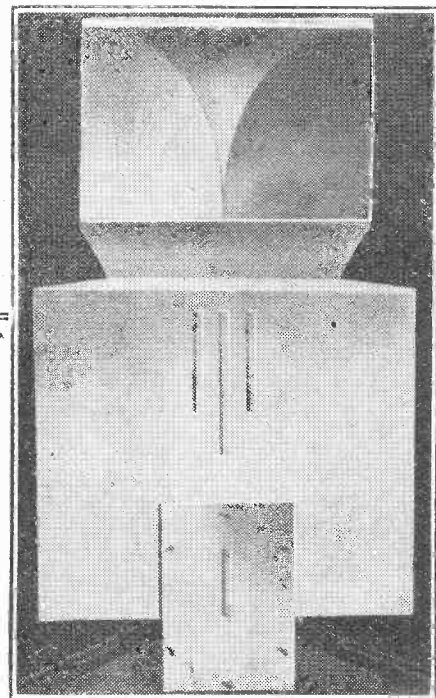
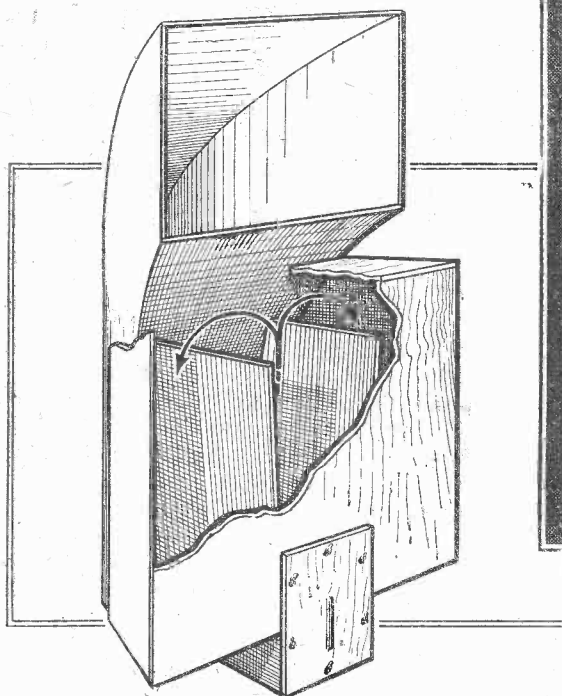

Voigt HC corner horn with the addition of a bass chamber for extending the low-frequency response. The radiation from the back of the diaphragm acts upon a divided air column with exits near the base of the cabinet.

easy to construct, and blue prints may be obtained, price 7s. 6d., by purchasers of moving coil units.

On test, a very considerable improvement in the bass response was observed, the cut-

off of adding the bass chamber to existing horns may be carried out at a cost of £5.

The address of the makers is Voigt Patents, Limited, The Courts, Silverdale, London, S.E.26.

Four-Band Transmitter

TUNING ADJUSTMENTS AND OPERATION

(Concluded from page 68 of the July 20th issue).

By S. K. LEWER, B.Sc. (G6LJ)

THE maximum RF power output from a transmitter is only obtained by correct adjustment of all circuits and accurate matching of the final stage to the aerial. These operations are explained in this article.

WHEN making tuning adjustments for the transmitter, it is very helpful to have a lamp-loop (a single loop of stout wire connected across a pocket-lamp bulb) and an absorption-type frequency meter in addition to the milliammeter. The lamp-loop serves as an indicator of RF current in any of the tuning coils when coupled sufficiently closely, and the absorption-type frequency meter is essential when it is desired to determine to which harmonic any particular circuit is tuned. Ordinarily, however, all the tuning adjustments can be made by observing the readings of the milliammeter when it is jacked into each of the circuits in turn.

The selection of the proper coils for operation on the four frequency-bands will be clear from a study of the table showing the circuit frequencies.

The adjustment of the four tuning condensers follows the normal procedure. First, the oscillator is tuned to give steady output as indicated by the fall in the anode current as the tuning control is varied, and by the use of the lamp-loop, and the buffer-doubler stage is tuned to give minimum anode current in the same way. The fall in anode current may not be very great, but it should be remembered that the circuits are already loaded by the capacity coupling, and the current at the tuning "dip" is made higher on account of the power taken out of the circuit in question.

The adjustment for neutralising is not at all critical, and it should be sufficient to vary the neutralising capacity by small successive amounts until no output is obtained from the KT8 stage when the crystal oscillator is detuned so as to cause it to stop oscillating. This test need only be made when 7 Mc/s output is required, since it is only in this case that the second KT66 is working as a straight amplifier. The power should be switched off, of course, each time the neutralising con-

denser is adjusted, unless a fully insulated type of construction is used.

The KT8 anode circuit, when not loaded in any way, will show a very substantial fall in anode current when it is tuned to resonance, and it is important to avoid running the valve more than momentarily in such a manner that the anode current has been depressed to 15 mA or less, since in this condition the

preliminary tests should be carried out with an artificial aerial. In this connection, the reader is referred to an article on aerial coupling systems which appeared in *The Wireless World* of March 9th, 1939.

The screen potentiometer R10 for the buffer-doubler will be found to afford sufficient control of the amount of power in its anode circuit, and care should be taken to avoid overdriving the KT8, particularly on the two lower frequency-bands. Overdriving is indicated by a fall in output when the amount of drive is increased.

It is important to keep a watch on the RF current passing through the crystal while adjustments are being made. The small lamp in series with the crystal, which should be of low current rating, such as 60 mA, will serve as an indicator of RF current through the crystal, but it must not be regarded as a fuse. Particularly when adjusting the tritet circuit, care should be taken to tune the oscillator cathode and anode circuits so that the lamp does not glow, or at least does not glow brightly. Heavy crystal current results in serious frequency drift due to the temperature rise, and there is also a danger of cracking the crystal.

Frequency Restrictions

The choice of crystal frequency is restricted in the case of a one-crystal four-band transmitter to a comparatively narrow part of the bands permitted by the P.M.G., since the harmonics of the 7 Mc/s crystal must lie within the limits of the three higher frequency-bands. Permits which have been granted recently are restricted to frequency limits such that there is no frequency in the 7 Mc/s band which has harmonics in the three higher ones, and in these circumstances two 7 Mc/s crystals are necessary for four-band operation, but those amateurs whose licences are of earlier date and who are permitted to operate within wider frequency limits, will find that one crystal frequency can be selected so as to meet the requirements for the four bands.

For telegraphy operation, the modulator power supply should be switched off and the secondary of the modulation transformer should be short-circuited by means of the switch S1. The keying should give clear cut operation, free from chirp, but if a chirp is found to be present, slight detuning of the buffer-doubler anode circuit to one side of the resonance or the other should overcome the trouble without appreciably reducing the output.

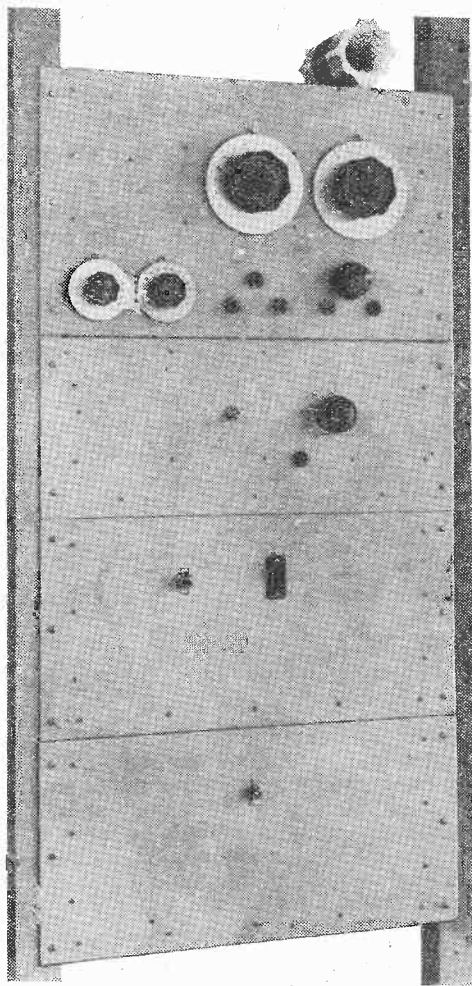

Complete assembly of transmitter showing RF chassis at the top, followed by the modulator, power supply for RF chassis and power supply for modulator.

CIRCUIT FREQUENCIES

Output	Crystal Oscillator		Buffer/Doubler Anode	P.A. Anode
	Cathode	Anode		
7	—	7	7	7
14	—	7	14	14
28	7	14	28	28
56	7	14	28	56

All frequencies are in Mc/s.

screen current is greater than normal and the consequent heating of the screen will give rise to screen emission. As soon as a load is put on the anode circuit, the anode current rises, and the dangerous condition no longer exists.

The adjustment of the aerial coupler will provide the current load in the ordinary way, although, of course, all

Four-Band Transmitter—

The keying circuit used here actually keys the oscillator besides the buffer and output stages. The transmitter is, therefore, quite silent while the key is up, and no change-over switch is required. The advantage which this affords by permitting "break-in" operation is very great, particularly in these days of severe con-

obtained have been completely satisfactory and the flexibility of the four-band operation has proved to be a very useful feature. The success achieved by any transmitter is, of course, dependent on the aerial systems in use, and proper attention must be given to their design, but these matters are outside the scope of this article. The transmitter described here,

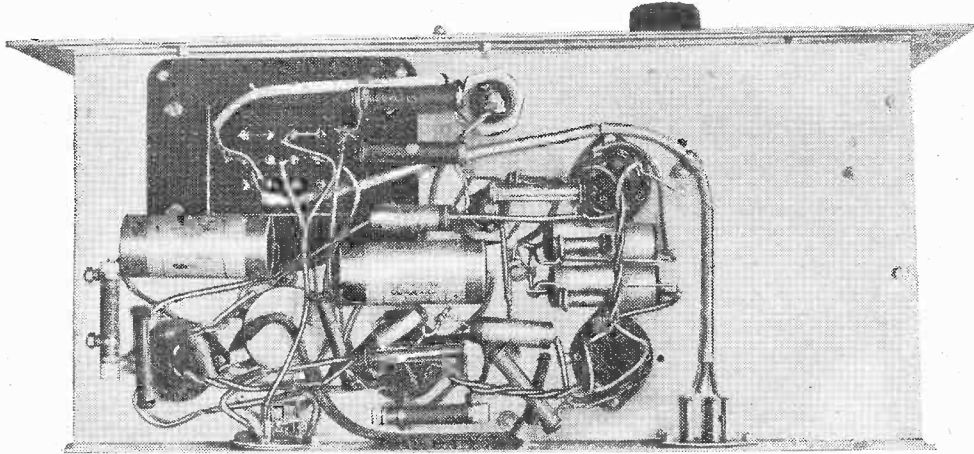

Under-chassis view of the modulator unit. The socket seen at the right carries the two-wire connection from the modulation transformer to the RF chassis. Ample space is available for fitting a further stage of amplification if it should be required.

gestion in the amateur bands, and the writer recommends that every opportunity should be taken to use this feature to the fullest extent.

For telephony operation, the key should be short-circuited by a switch suitably placed on the operating table, or the key plug may be withdrawn from the jack. The switch S₃ on the RF power supply should be opened for telephony working in order to reduce the voltage to a safe value, as previously explained. The modulation transformer secondary switch S₁ must be opened, and the gain control adjusted to give the desired depth of modulation.

The adjustment of the potentiometer R₂₄ for giving equal drive to the two KT66 modulator valves can be found with sufficient accuracy by removing each one of the KT66s from its socket in turn and adjusting the potentiometer until the same increment of RF output current in the aerial circuit occurs with either valve working singly. The increment of RF output is best measured by means of a hot-wire ammeter (or one of the thermo-junction type), or more crudely by estimating the increase in brilliancy of a lamp coupled to the output circuit when full modulation is applied. Of course, the gain control R₁₆ must not be altered while this comparison is being made.

Full modulation is obtained when the aerial current increases by about 20 per cent. while a pure tone of sinusoidal waveform is directed into the microphone. For average speech, the increment of aerial current is much smaller than 20 per cent., and care must be taken to avoid over-modulating at the momentary peaks which normally occur in speech, for such incorrect adjustment causes very serious interference with adjacent frequency channels.

Although the transmitter has not been used over a long period of time, the results

used in conjunction with suitable radiating systems for the four frequency-bands, will be found to meet most amateur requirements in this country and may be relied upon to give a lasting and satisfactory performance.

Principles and Practice of Radio Servicing, by H. J. Hicks. Pp. 305+x. Published by McGraw-Hill Publishing Co., Ltd., Aldwych House, London, W.C.2. Price 18s.

ALTHOUGH this book deals primarily with wireless servicing, quite a large part of it is devoted to circuit theory. It opens with chapters on the "Fundamentals of Magnetism and Electricity" and "Fundamentals of Radio." Save that the material is not arranged alphabetically, the treatment here is on the lines of an encyclopedia, many paragraphs consisting of definitions. These are followed by a chapter on valves.

The question of test apparatus is then tackled and is much better done, although the treatment of set-analysers is rather sketchy. Multi-range voltmeters and milliammeters are well described, however, as is also the calibration of an RF oscillator.

Chapters on the theory of RF and AF amplification follow, and it is unfortunate that several errors occur here. It is, for instance, stated that chokes are better than resistances for AF decoupling, whereas both theory and practice show that resistances are much better on account of the very low frequencies involved. The author also suggests as a cure for motor-boating the improvement of the regulation of the power supply by the use of a larger mains transformer, a mercury-rectifier, lower resistance smoothing chokes, and a choke input filter. Cases in which these expensive remedies will effect any substantial improvement are rare, however, for the important factor is the output impedance at very low frequencies, but not at zero frequency. This is governed chiefly by the chokes and condensers. In practice, the usual resistance-capacity decoupling circuits are much cheaper and much more effective.

The chapter on power supplies contains over five pages on three-phase supplies, which the average service man encounters quite rarely. The rest of the book is much more satisfactory and consists to a large extent of a description of portions of receiver circuits with a description of the symptoms of likely faults. All the ordinary problems are dealt with and there is a long chapter on Public Address Systems. The book concludes with a useful Appendix, in which are included tables of wire and drill sizes, valve characteristics, and underwriters' regulations. This data is, of course, all referring to American practice. W. T. C.

Television Programmes

Sound 41.5 Mc/s

Vision 45 Mc/s

An hour's special film transmission intended for demonstration purposes will be given from 11 a.m. to 12 noon each weekday. The National or Regional programme will be relayed on 41.5 Mc/s from approximately 7.45 to 9 p.m. daily.

THURSDAY, AUGUST 3rd.

3, "Here's Looking at Them," a revue. 3.30, Gaumont-British News. 3.40, "The Open Door," a duologue.

9, "Order to View," No. 4—a revue. 9.40, British Movietonews. 9.50, Blood Donors, a demonstration of the simple tests and minor operation to which volunteers are subjected. 10.5, Cartoon Film. 10.10, Film. 10.20, Music Makers: Catherine Clark, pianoforte.

FRIDAY, AUGUST 4th.

3-4.15, "The Day is Gone," an eerie play by W. Chetham-Strode.

9-10.30, Film, "Le Patriote."

SATURDAY, AUGUST 5th.

3, Nancy's Puppets. 3.10, Cartoon Film. 3.15, Model Trains. 3.25, British Movietonews. 3.35, Charles Heslop in "Percy Ponsonby Packs for Bank Holiday." 3.45, Film.

9, Beatrice Lillie. 9.15, Cartoon Film. 9.20, Bee-Keeping. 9.35, Albert Sammons playing Mozart's violin concerto in G. 10, "The Tram Conductor," a monologue. 10.10, British Movietonews. 10.20-10.30, Cartoons by Oscar Berger.

SUNDAY, AUGUST 6th.

9.5, "Mr Jones Dines Out," one-act comedy by Stuart Ready. 9.35, Film, "Zoo Babies." 9.45-10.20, Symposium on Swans.

MONDAY, AUGUST 7th.

3-4, O.B. from the White City of the International Sports Meeting.

9, A Gershwin programme by Eric Wild and his Band. 9.30-10.30, Western Film, "Galloping Dynamite."

TUESDAY, AUGUST 8th.

3-4.25, Nova Pilbeam in "Prison Without Bars," a tragic-comedy of youth by Peggy Barwell.

9, The Season's New Ballroom Steps. 9.20, Gaumont-British News. 9.30, Artificial Eyes—demonstration of the construction of a glass eye. 9.45, Film. 10, Cartoon Nonsense by "Nel." 10.15, Cartoon Film. 10.25-10.35, Mark and Michal Hambourg.

WEDNESDAY, AUGUST 9th.

3, Cartoon Film. 3.5, Renée Houston and Donald Stewart in Cabaret. 3.35, British Movietonews. 3.45, Pam Norris plays some children's tunes. 3.50-4.10, Film on Bermuda.

9, "Rule Britannia"—Ballads of Britain and of the Seven Seas. 9.45, British Movietonews. 9.55-10.25, A. P. Herbert's play, "Plain Jane."

NEWS OF THE WEEK

PAYING FOR TELEVISION

Sponsored Programmes?

THE possibility of introducing sponsored programmes into the B.B.C. television service has not been widely canvassed, probably because most of the "prophets" have overlooked the fact that such a course was considered permissible by the Television Committee in its report to the Postmaster-General in 1935.

"We see no reason," ran paragraph 65 of the Report, "why the provision concerning sponsored programmes in the existing Licence should not be applied also to the television service, and we think it would be legitimate, especially during the experimental period of the service, were the Corporation to take advantage of the permission to accept such programmes."

It is not unlikely that the Television Advisory Committee has borne this clause in mind in its recent report to the Postmaster-General and that the B.B.C. might, in certain circumstances, be prepared to act upon it.

Direct advertisement would be avoided, but the Corporation might be prepared to admit programmes containing a brief acknowledgment of a sponsor. Whilst the B.B.C., by the terms of its Charter, would not be permitted to accept payment for the inclusion of such programmes, the service would benefit in that the sponsors would presumably pay the artistes.

COLOUR TELEVISION

Mr. Baird's Latest Experiment

AS long ago as 1928, Mr. J. L. Baird demonstrated small flickering television pictures in colour at the British Association meeting at Glasgow and again in February last year, he demonstrated a mechanical-scanning system of coloured television to an audience at the Dominion Theatre, London.

Last week, at his laboratories in Sydenham, he used his latest apparatus which utilises a cathode-ray tube with a mechanical scanner to project pictures on to a screen three feet square.

Between the cathode-ray tube and the lens in the receiver a scanning disc with blue-green and orange-red filters revolves so that tinted pictures are thrown in sequence and combine on the screen to form the coloured picture.

The scanner in the transmitter, which was at the Crystal Palace, consists of a mirror-drum with thirty-four facets and a colour

THE WORLD'S LISTENERS

Denmark Leads Europe

THE annual figures issued by the Union Internationale de Radiodiffusion giving the increase in the number of listeners in the world during the preceding year shows that nearly half the world's receivers are in use in Europe. The approximate figures are: Europe 38,600,000, the rest of the world 39,400,000.

As there is no licensing system in the U.S.A., exact figures for that country are not obtainable. The figures, however, supplied by the Federal Communications Commission, place in U.S.A. as the most radio-minded country in the world with a total of 28,000,000 receivers. This figure gives a proportion of just over 215 sets per thousand inhabitants.

Denmark retains the second place with nearly 206 receivers per thousand. Great Britain has been relegated from the third to the fifth position with nearly 193 per thousand. The third and fourth places being taken by New Zealand and Sweden respectively. Germany is tenth on the list with 133 per thousand.

The approximate total of listeners in the world is given as 312,000,000. In arriving at this total, estimated figures for Russia, Brazil and China have had to be taken into account as no returns have been made by these countries.

disc similar to that used in the receiver.

A complete picture of 102 lines is produced by triple interlacing with a frame frequency of 16 $\frac{2}{3}$ c/s.

THE LISTENER AND HIS SET

WHILST it is hardly likely that readers of *The Wireless World* need demonstrations to show them whether or not they are getting the best from their receivers, they will doubtless be interested in a forthcoming broadcast entitled "The Ordinary Listener and his Set" to be given by Mr. R. A. Watson Watt.

During this talk, which will be broadcast Nationally on August 17th, recordings will be used to illustrate the effect of the maladjustment of a receiver on its performance. Recordings will also be employed to demonstrate the different methods of overcoming electrical interference.

CATERING FOR ALL TASTES. This year's Radiolympia poster, which is here reproduced in miniature, shows, in a way which previous posters have failed to do, the diversity of the Exhibition's appeal. This poster is but one way the R.M.A. is endeavouring to make people Radiolympia-conscious.

LET'S ALL GO TO THE RADIO SHOW

ADMISSION 1/- AUG 23rd - SEPT 2nd to 10 daily

EYES & EARS THE NAVY ARMY R.A.F.	RADIO THEATRE 4 SHOWS DAILY 4 TELEVISION IN THE MAKING KENTUCKY MINSTRELS I WANT TO BE AN ACTOR PICTURE PAGE FASHION PARADES VARIETY SEE YOUR FAVOURITE STARS
CINEMA BEHIND THE SCENES AT THE B.B.C. MODEL G.P.O. FACTORY EXHIBITS	

★ COME AND BE TELEVIEWED ★

RADIOLYMPIA

AMATEURS IN WAR TIME

Government Statement

AS was expected, the Postmaster-General, in reply to a question in the House of Commons, announced that it had been decided, after consultation with the Government Departments concerned, that it would be essential in time of war to close down the wireless transmitting sets used by experimenters. He added that he understood steps had been taken by the Admiralty and the Air Ministry to enrol a number of suitable wireless experimenters in special wireless units in time of emergency. These, of course, are the Royal Naval Wireless Auxiliary Reserve and the Royal Air Force Civilian Wireless Reserve.

During the Great War receivers as well as transmitters had to be surrendered. This procedure would not, of course,

be adopted in the event of war now, for broadcasting is counted as a national service, and would most certainly be invaluable to the Government for disseminating news and instructions.

WORLD MORSE CHAMPIONSHIP

75 w.p.m.!

IT is reported from the U.S.A. that, by "taking perfect copy for a period of 15 minutes at 75 words per minute," Mr. T. R. McElroy has retained his world championship for high-speed morse, and also set up a new record. The contest was conducted under the auspices of the Federal radio authorities.

Mr. McElroy acts as resident American buyer in Boston for the British firm of Webb's Radio.

THE "A" CODE

R.S.G.B. and A.R.R.L. Decision

THE Radio Society of Great Britain has now concluded a very thorough examination of the "A" Code, with a view to ascertaining whether this proposed new signal-code (which was described in *The Wireless World* for May 11th) could be brought into world-wide use to meet the needs of amateur transmitters.

After fully considering the draft code in all its aspects, and having had consultations with the American Radio Relay League on the subject, the R.S.G.B. Council has come to the conclusion that it cannot see its way clear to putting forward the "A" Code for inter-

national adoption. Both the R.S.G.B. and the A.R.R.L. incline to the view that new signal abbreviations for amateur use should take the form of additions to or modifications of the existing "Q" Code.

AIR RADIO SERVICE

BY means of a reciprocal arrangement with foreign air lines and ground stations, Imperial Airways has for some years offered facilities to passengers on the Empire routes for the receipt and despatch of radio telegrams in the air. This service was extended from Tuesday, August 1st, to planes on the Continental routes, with the

News of the Week— exception that telegrams cannot be sent from ground stations in the U.K., Ireland and France.

The arrangement will, of course, be subject to the exigencies of the radio service in regard to navigation.

RATIONALISING THE GERMAN INDUSTRY

Limiting Receiver Types : Interference Legislation

FULL details of the orders regulating the rationalisation of the German broadcast industry were officially published on July 29th. These regulations, issued by General Fellgiebel, who was recently put in charge of the entire German electrical communications industry, become law under the Four Year's Plan for economic independence.

The radio industry has been organised into twelve groups of manufacturers, the members of which will jointly manufacture receivers which must be for AC or AC/DC operation.

Apart from the People's Receivers, only the following sets may be manufactured by the groups: a high efficiency receiver (probably a small superhet) at a medium price; a large superhet; a car radio receiver and a high-quality set for the reception of the local station and the wired wireless service.

Portables and special purpose receivers may only be manufactured if there is a demand for them in Germany or, alternatively, if they are required for export. Public address amplifiers have been standardised at 20, 120 and 500 watts output.

Components must be chosen from those types which are also suitable for use in apparatus for National defence. Individual or hand-made construction must give place to mass production throughout the industry.

To prevent the selling of last season's sets at reduced prices, the industry has been ordered to continue the production of the new types for a longer period than hitherto.

The number of types of valves

has already been reduced from sixty-six to twenty-three and instead of 100 different loud speakers, there are now fourteen.

The number of types of resistances has been drastically reduced; from 1,000 to 17!

The immediate suppression of all sources of man-made interference is to be enforced which, with the introduction of television means that all motor cars must immediately be fitted with anti-interference suppressors.

Commenting on these developments, which seem to put an end to yearly progress, the official German Party newspaper states that a wireless set has now become a common instrument of daily use and therefore it was time to rationalise and standardise production to ensure quality with cheapness. The comment closes with the words, "we will thus have technically the best set in the world, and this set will be purchasable by the widest circle of people."

AFRICANS AND BROADCASTING

A SCHEME for establishing a broadcasting service in Uganda is envisaged in a recent report on the reactions of Africans to broadcasts through public-address equipment. The scheme is essentially educational, for it is pointed out that broadcasting is the only means of reaching the masses.

It is proposed to inaugurate the service either with a 20-kW medium-wave station or a 10-kW short-wave station and a 2-kW medium-wave transmitter. The provision of 300 communal receivers is also proposed.

VILLAGE RECEIVERS

SO far the most formidable obstacle in the path of popularising wireless in India has been the lack of an entirely satisfactory village receiver. Two models now being tested by the Research Department of All-India Radio are based on data gleaned from the use of seven experimental models installed in villages around Delhi by A.I.R. during the past three years.

Both the receivers cover the short and medium wavebands, thereby ensuring good reception throughout the year. The problem of village receivers is essentially that of economically maintaining and running battery-operated sets, for few villages have an electric supply.

AN INTERNATIONAL MEETING

MANY well-known names appear in the list of lecturers at the International Meeting on Physics, which is to be held in Zurich during the Swiss National Exhibition from September 4th to 17th. The second International Television Meeting will be held during this period and the following will be among the speakers: Mr. Blumlein (E.M.I.), Dr. von Okolicsanyi (Scophony), Dr. Strutt (Philips), Dr. Zworykin (R.C.A.), Dr. Lubszynski (E.M.I.) and Dr. D. M. Robinson (Scophony).

During the meeting devoted to high-frequency, Mr. T. L. Eckersley, of Marconi's, and Mr. W. T. Gibson, of Standard Telephones and Cables, will be among the speakers.

FROM ALL QUARTERS

Expedition's Transmission

THE eighth annual expedition of the Public Schools Exploring Society will be to Newfoundland. The party of forty-six boys under the leadership of Surg. Commander G. Murray Levick, R.N., left for Newfoundland on August 1st. During the period of the exploration, which will be from August 9th to September 6th, the transmitter at the base camp will be transmitting daily between 9 and 11 p.m. G.M.T. on 7.104 and 2.552 Mc/s under the call signs G8XY and G8XZ.

Wireless Beacon at Longstone Lighthouse

AUTOMATIC marine wireless beacons are to be installed at Longstone Lighthouse in the Farne Islands and on the Outer Gabbard Light Vessel, by the Marconi Company. The initials of Grace Darling, who lived in the Longstone Lighthouse, preceded by the distinctive letter M allotted to the beacons around the British Isles, have been used for the beacon's call sign, MGD.

Meteorological Stations

IT has been decided to establish wireless stations on the Islands of Minicoy and Ameni, off the south-west coast of India, which are entirely cut off from the mainland during the south-west monsoon. The islands' transmitters will send meteorological information to the mainland stations at Calicut and Malappuram.

American Enterprise

AN American broadcasting organisation is reported to have approached the Finnish Government with a view to purchasing or hiring a Finnish short-wave station or, alternatively, to constructing its own transmission line from Helsinki to Stockholm in order to meet American requirements for broadcasts from the 1940 Olympic Games. Since the suggestions involve a violation of the Finnish Communications Act, they have been turned down.

Programme Director Retires

WITH the retirement of M. Emile Brémond, Director of Programmes, the French State Broadcasting Service has suffered a big loss, for he has been responsible for the correlation of the programmes. He leaves the broadcasting service to undertake the direction of the French daily newspaper, *Le Progres de Lyon*.

Sponsored Programmes

DURING a recent discussion in the Norwegian Parliament on the State broadcasting organisation's budget for 1939-40, the question of sponsored programmes was raised. It was moved that the Norsk Rikskringkasting be notified that the majority of listeners and members of Parliament would appreciate the abolition of the present daily quarter-of-an-hour transmission of sponsored items. The Parliamentary debate has evoked strong protests from commercial organisations.

Greek Radio Tax

OWNERS of receivers in Greece must comply with a decree which demands that all receivers must be registered for taxation within a month. The tax so far as private houses are concerned, varies from 3s. 9d. to 11s. 3d., according to the value of the receiver; schools will have to pay 7s. 6d. Receivers in cafés, hotels and cars will be taxed at £1 2s. 6d., whilst owners of sets in yachts, trains and aeroplanes will have to pay £1 17s. 6d. per annum.

French Licence Fee

ACCORDING to statements which have appeared in various Parisian daily newspapers, the licence fee in France is likely to be increased from 50 to 70 francs next year.

Italo-German Television

THE German Post Office Television Company, which was formed some months ago, has taken over the complete technical operation of the studio equipment of the Italian television service, which opened on July 22nd, using a frequency of 44 Mc/s for vision and 40.5 Mc/s for sound.

The Berlin Radio Show

IT has been definitely stated that this year's Berlin Radio Exhibition, which opened last Friday, will be the last of the series which have been held annually for the past sixteen years. Next year there will only be a radio section at the International Transport Exhibition in Cologne.

Northants Television Development

LEADING radio dealers in Northants have formed the Northampton and District Television Development Association with a view to impressing upon the Government the necessity of television becoming an immediate national proposition.

Italian "Youth" Set

At the Rome Fair, a new "popular set" for youth has been introduced to take the place of the former model. It is called Radio-Roma and will be available to the public by September 15th.

Danish Radio Benevolence

To mark the tenth anniversary of the Danish radio benevolence fund (Dansk Radio Hjaelpfond) 500 free receivers are scheduled for distribution in the autumn. By that time the institution will have presented more than 3,200 sets to citizens who would not otherwise have had access to broadcast programmes. Incidentally, about 61,000 registered listeners (8½ per cent. of the total), are for social reasons exempt from payment of the annual licence fee. In this respect Denmark is believed to hold a world record.

Miscellaneous Advertisements

As announced last week, slight alterations in our printing arrangements are necessary with the approach of August Bank Holiday. Miscellaneous advertisements, therefore, intended for the issue of August 10th must be received not later than first post tomorrow, Friday, August 4th.

Mastering Morse

SELF-INSTRUCTION BY AN UNUSUAL METHOD

By A. R. KNIPE

THE greatest handicap to the learning of Morse is undoubtedly the lack of a skilled operator to work the key so that proper receiving practice may be obtained. In this article an unusual and easily constructed device is described whereby this disadvantage is, to a certain extent, overcome.

THE principal advantage of the apparatus to be described is that accurate morse symbols, code abbreviations, and even short words can be transmitted with their correct rhythmic sound values at any desired speed, either by the learner himself or by a friend who has no knowledge of the morse code. In addition, the device is simple and cheap to construct. Fig. 1 is a view in plan of the complete instrument, and it will

be seen to consist of a baseboard *a* which may be cut from $\frac{3}{8}$ in. or $\frac{1}{2}$ in. thick plywood; a "signal plate" *c* made from a piece of thin flat sheet brass, aluminium or ordinary tinplate; and a stencil *b* which may be formed from a sheet of insulating material such as empire cloth, thin celluloid, or even stout paper. There are also a number of thin wooden strips *d*, slightly wider than the signal plate, each strip being drilled for wood screws at the ends. These strips of wood secure the stencil to the signal plate, and also clamp these two items firmly to the baseboard, in addition to serving as guides for the stylus brush *e*.

This stylus brush is the means whereby the morse signals are transmitted, its exposed end making contact with the signal plate through the stencil, thus closing the buzzer circuit. It may be constructed from a length of insulated wire cable such as one strand of twin lighting

flex. It should be stiffened for a distance of about 5in. at one end to enable it to be held like a pencil in the hand. One method of achieving this is to wrap a strip of glued cartridge paper around the cable so as to encase it in a more or less rigid tube, taking care to ensure that the bare copper wires project for a distance of about $\frac{3}{32}$ in. from the extreme end.

The construction of the stencil sheet, which is the only portion of the whole apparatus on which any real care need be expended, is accomplished in the following manner: A sheet of stout paper of the required size is divided transversely by a series of parallel lines ruled $\frac{1}{16}$ in. apart. The morse characters to

be transmitted are then marked off between these lines, taking care to leave an adequate space between each complete character, and to make the length of the symbols conform to the recognised morse code standards. These lay down that the space between a dot and a dash should be equal to the duration of a dot, and the length of a dash equal to three dots. Actually the spacing between elements should be increased slightly to allow for the thickness of the stylus brush. To

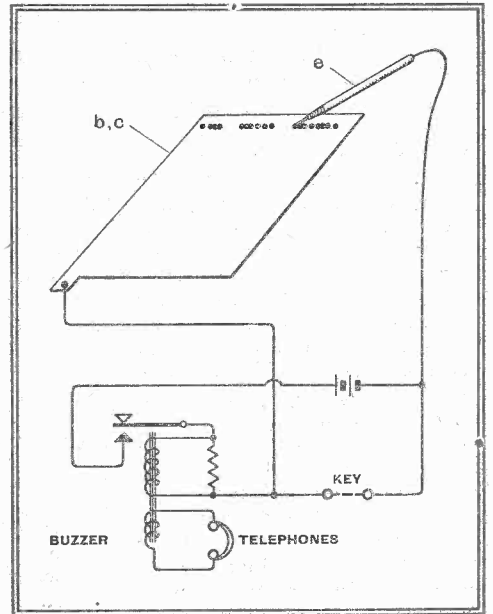
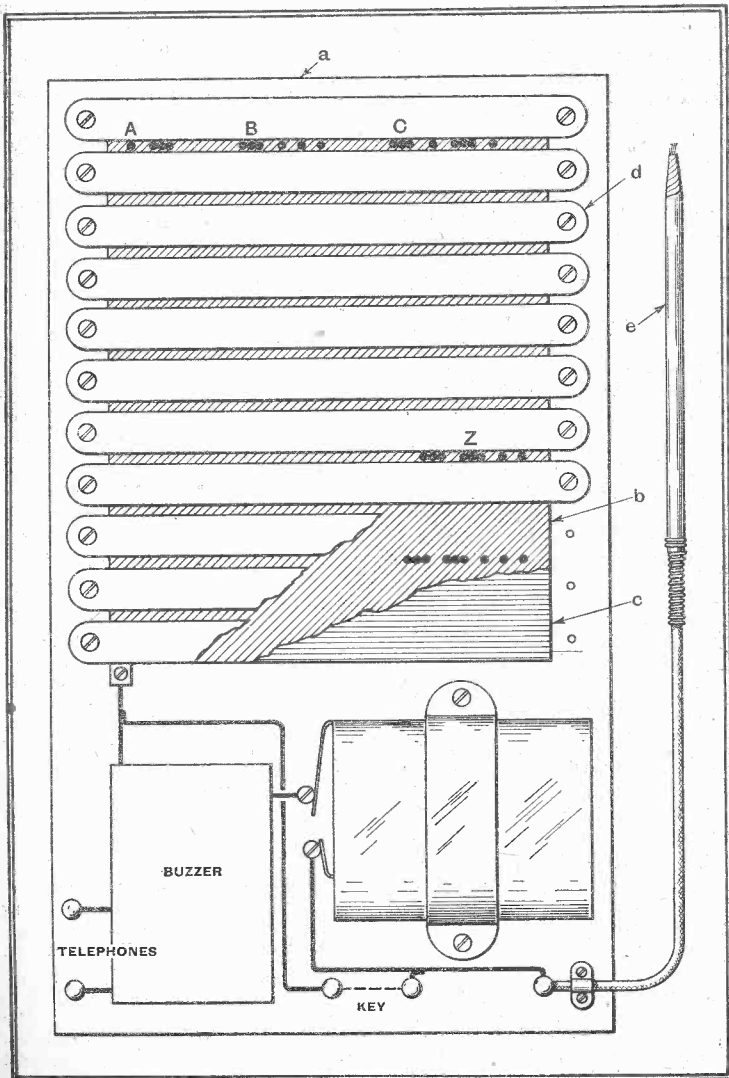

The electrical connections. The separate headphone winding may consist of a few turns of wire wound over the buzzer bobbins.

illustrate the foregoing it may be mentioned that the morse letter "A" is formed by marking off a distance of $\frac{1}{16}$ in. on one of the parallel lines to represent the dot. This is followed by a space of $\frac{3}{16}$ in., and then a distance of $\frac{3}{8}$ in. is marked off for the dash. The above method may appear rather laborious, but in practice this is not the case, for an $\frac{1}{16}$ in. diameter hollow punch can be used for piercing the holes, and three holes touching each other (the thin webs being afterwards removed) gives the correct length for a standard dash.

Preparing the Stencil

The desired morse characters having been drawn, the paper may be pasted to a sheet of empire cloth, and, when dry, this may be placed on a smooth piece of wood, and all the holes forming the dots and dashes punched through the cloth, using a sharp hollow belt punch for the purpose. The paper is next damped and peeled away leaving an insulated stencil. If the paper used has been tough and of good quality it is quite feasible to employ

The construction of the unit is quite simple and straightforward.

Mastering Morse

this as the stencil itself, and thus dispense with empire cloth or other better-class insulator. Finally, the stencil sheet may be cemented to the signal plate with shellac varnish or cellulose cement, or, if desired, it may be merely held in place by the wooden clamping strips.

The assembly of the remainder of the apparatus is quite straightforward, the signal plate and stylus brush being wired in place of an ordinary morse key, as depicted in Fig. 2. It will be noticed that an additional winding has been provided on the buzzer for headphones. A few turns of wire over one of the bobbins of the buzzer is usually all that is necessary. To avoid disturbing other members of the household unnecessarily, the buzzer can be

mounted on sponge rubber, and enclosed.

The device is held by the left hand like a writing pad, and the stylus brush inclined at a slight angle to the vertical while being drawn steadily from left to right in the gap between the wooden strips, the point of the brush pressing lightly on the stencil surface. The action is as though the characters were being crossed out as they are transmitted. The speed of passage of the brush may be progressively increased as the rhythmic sounds of the morse symbols are memorised. A buzzer has been employed in place of a valve oscillator, to make the apparatus simple and completely self-contained. The writer would like to stress, however, the importance of obtaining a good quality high-note buzzer.

describes it as the cleanest of all primary cells. The only snag is that the EMF is but 0.9 V per cell. Some nominal 2-volt valves will work with a filament battery voltage as low as 1.8, but others won't; anyhow, with two 0.9-volt cells in series there's absolutely nothing to play with.

Running Costs

No one has described any experiences with the bichromate cell. This gives a full 2 volts, and I know that it will supply a heavy current, for a time at any rate. If the zinc is well amalgamated and made so that it can be lifted clear of the electrolyte when the cell is not in use, can a cell of suitable size supply, say, 0.6 ampere for two or three hours a day without running costs being too ruinous? The big difficulty with primary cells seems to be that the non-messy ones that have the necessary volts won't supply the amperes required, and vice versa.

A Quaint Plug

DO you remember my mentioning some weeks ago that I'd read in an American paper that numerous fatal accidents were caused each year on the other side of the Atlantic by the reprehensible habit of yanking wall plugs out of their sockets by the leads? I wondered then whether the plugs had no kind of finger-grip, and whether there was no anchorage for the leads. A British Columbian reader has just sent me what he assures me is a fair sample of the plugs used in Canada and the U.S.A. Having examined it, I'm not surprised that untoward things are apt to happen with it! Imagine a very small mushroom provided with twin flat stalks, and you have a fair picture of it. The "stalks," which form the prongs, are simply brass strips $\frac{1}{8}$ -inch wide and less than $\frac{1}{16}$ -inch thick. The wires go in through a hole in the mushroom top, and the only anchorage is that provided by the terminal screws. These screws, by the way, are exposed, for there is no cover to the underside of the mushroom. Uncle Sam might do worse than take a look at our plugs! The standard mains voltage in the U.S.A. is, of course, only 110; shocks may be common, but I should think that fatalities are much rarer than was suggested by the journal from which I quoted.

Twisted Joints

Not everyone agrees with my condemnation of the twisted-up joint made in flex wire as being unreliable unless it is subsequently soldered. A reader points out that the G.P.O. telephone people use thousands of them in their underground cables running through conduits, and have little trouble with them. Others write of similar joints in flex HT battery leads that have been in use for years, and still seem to be as good as ever. You may or may not remember that my uncomplimentary remarks about twisted joints were inspired by a fault that had developed in the LT leads of a portable, which had been lengthened some time previously. A service engineer writes that he deals each week with about a dozen sets whose HT and LT leads have been extended by means of twisted joints to enable batteries supplied by a hire service to be used. "I find," he says, "that, whilst the HT leads give very little trouble, about one in twelve of the LT leads requires attention." Am I right in surmising that the twisted joint will stand up to a current of a few milliamps, but becomes unreliable when called upon to carry half an ampere or more?

Random Radiations

Curses Loud and Deep !

AN hour or two before this note was written I found myself heartily echoing (though in less polite language) the plea made recently in a *Wireless World* editorial for bigger and better instruction books to accompany receiving sets. A smallish communication receiver had proved so strangely insensitive on one of its short-wave ranges that it was clear that the trimming had slipped somewhere. Deciding to tackle the job straight away, I consulted the book of words to ascertain the intermediate frequency. No figure for this was given, so I had to telephone the makers at ninepence per three minutes—and the "pips" went twice before they could tell me what I wanted to know. But I wasn't yet out of the wood; in fact I'm still in it. The book contains a circuit diagram in which each condenser, resistance and so on is numbered; you have only to look up its number in a neat table on the next page to discover the value of any component and the part that it plays. But there is no corresponding layout diagram to enable the padders and trimmers to be located and identified. There are four short-wave ranges, so one needs a little help in this way! As I can't afford any more two-and-threepenny 'phone calls, I've sent an SOS by post, and put off doing the job until the diagram (if one exists) makes its appearance.

Please !

Set manufacturers may possibly defend the sketchy and inadequate instruction book that goes out with so many broadcast receivers on the grounds that they don't want to encourage the uninitiated to mess about with the innards of their sets; hence the less technical information given, the better. That's as may be. But the communication receiver and the short-wave sets are surely in an altogether different category. They are mostly bought, one imagines, by folk who know something about wireless and like to be able to "hot up" their own sets, or to readjust them when the need arises. You can, of course, puzzle out a complicated layout if you've sufficient patience and enough time on your hands. But it's exasperating to have to do so, particularly because you realise that the work you are doing should be completely unnecessary. Will those who make such sets please lend an ear! Some

By "DIALLIST"

books of the words contain everything that one wants to know about the sets with which they go; that should be true of all that concern C.R.s and short-wave sets. May it be so this coming season.

A Queer Decision

JUST why the organisers of Radiolympia have seen fit to put their collective foot down on the proposed A.R.P. exhibit is a little difficult to understand. We are told that it might have the effect of inducing the wrong frame of mind in visitors at the very time when those responsible for the Exhibition want them to feel most happy! What exactly is meant by the wrong frame of mind I don't pretend to know; but I can't for the life of me see why the A.R.P. exhibit that had been planned should have had any very disturbing effect on anyone. Actually, a large proportion of those who go to Radiolympia are likely to be members of one or other of the Defence Services, and to them the A.R.P. sideshow would have been full of interest. I hope the R.M.A. will reconsider this decision. We're not suffering from jumpy nerves, so it's a pity to do anything that suggests that we are.

The Soda Cell

MY best thanks to those readers who have been kind enough to send me suggestions for solving the LT current supply problem in out-of-the-way corners of the Empire, where accumulator charging is impossible. Most of the ideas sent in are ingenious and interesting. One reader mentions a primary cell that is new to me, but seems to have distinct possibilities for filament heating. This is the Edison Soda Cell, which is now used by the signal and telegraph departments of some railways for track circuit working. In such a circuit the cell is under a continuous small load, with frequent brief periods in which it is almost on dead short circuit. In these conditions it lasts for six to nine months, needing no attention until a renewal is called for. The electrodes are in one block, and the chemicals for the electrolyte are packed dry in a tin. It can thus be sent by parcel post. My correspondent

Letters to the Editor

The Editor does not necessarily endorse the opinions of his correspondents

Valve Prices : Official Statement

IN connection with the references in your issue of July 20th, 1939, to the prices charged to the public for valves, it is desired to advise you that no reductions in their prices are contemplated at the present time.

It should be borne in mind that experience has amply demonstrated that the valves manufactured by the members of this Association give an exceptionally long life, and it is the fact that the sales of valves for the maintenance of existing receivers is very small in relation to the sales of valves for new sets.

The foregoing, taken in conjunction with the guarantee and generous service offered by the English valve manufacturer, results in the average cost of new valves to listeners being of the order of only a shilling or two per receiver per annum. Since this small sum attaches to the use of perhaps five valves, for some thousands of hours per annum, it may be accepted that its incidence upon the public is extraordinarily low and does not constitute any hardship.

D. P. WHEELDON,

Secretary, British Radio Valve Manufacturers' Association.

"nastiness" is not possible, and therefore the only really sound method expressing the total distortion is by a statement of the percentages of each separate harmonic. This requires three numbers and three calculations to obtain them. Clearly a single index number would be preferable if one can be found that is easy to derive and that is not too misleading in its indications. But there is no point at all in going to any trouble to obtain a figure that is of academic interest alone.

Consider two possible examples of distortion. One consisting of 6 per cent. 3rd harmonic alone, and the others of 2 per cent. 3rd, plus 2 per cent. 5th, plus 2 per cent. 7th harmonic. There are reasons for believing that the former will be the more pleasing. But the RMS sum of the harmonics gives 6 per cent. for the former (least harmful) and 3.5 per cent. for the latter. To what purpose have we squared three numbers, added the results together, and then taken the square root of the answer? The straightforward arithmetical sum is every bit as good as a guide to effective distortion (better in the example given), requires no aptitude

for mathematics and saves a lot of time. In addition to this, there is another thing that adds to the usefulness of the "Partridge Distortion Index." A glance at the transformer distortion curves given in the articles will show that *very approximately* the 3rd harmonic is generally about 50 per cent. of the arithmetical total, while the 5th and 7th harmonics are each around 25 per cent. Thus one always has a very fair idea of the whole story. In brief, the RMS summation involves more work and produces a less convenient "Index" than the arithmetical sum.

Lastly, there is the affair of the 20 phons. I fear that my imagination was so fired by the discovery that 2 per cent. 7th harmonic *could* sound like 100 per cent. that I told the world about it without stopping to consider the subdued nature of the experiment. However, we agree about the principle of the thing, so perhaps I may be forgiven for this unintentional exaggeration. But I am not so sure about the masking effect. The fundamental might mask the harmonic *as such*, but would it cover beats against a near-by frequency? N. PARTRIDGE.

London, S.W.1.

"Distortion in Transformer Cores"

BEFORE replying to the technical points raised by Mr. Scroggie in his letter of last week, I should like to express my appreciation of the exceedingly nice things he said about my articles on "Distortion in Transformer Cores." And at the same time may I be allowed the space to thank the many other readers who have written to me privately about the same matter?

Mr. Scroggie's first point relates to amplitude distortion and intermodulation products. The reason for my "summary dismissal" of this matter is that it did not seem quite so important in the case of a transformer as in that of a valve (for example) because of frequency discrimination in the former. Only spurious frequencies of a low order can find their way to the external load. However, it is quite possible that I have under-estimated this evil.

The next item, which deals with my use of the *arithmetical* sum of the harmonics, is very important. The "Partridge Distortion Index" is intended to fulfil two purposes: (1) to provide a simple means whereby professional engineers and amateurs alike can make reliable comparisons between transformers, and (2) to provide the transformer designer (as distinct from the circuit designer or transformer user) with a convenient means of dealing with distortion calculations. As Mr. Scroggie states in his letter, it is purely an index number associated with output transformers, and therefore does not in any way come into conflict with existing standards.

It is well known that the offensiveness of harmonics varies considerably with their order. We are particularly concerned with the 3rd, 5th and 7th harmonics, and of these the 3rd is the least harmful, while the 5th and 7th are suspected of being vastly more sinister. An exact measure of the relative

DETAILS of the new models which will be added to the H.M.V. range of television receivers on August 29th are now available. The new instruments all incorporate the same chassis, which is a superheterodyne with a new high-slope valve of compact design (the Z62) in its RF stage. The frequency changer is followed by two IF stages common to sound and vision, and these are followed by additional separate stages for sound and vision. The sound channel includes a "hiss limiter" circuit which takes a portion of the output and feeds it out of phase through a diode into an earlier point in the circuit. This feature has been introduced primarily to combat motor car interference.

On the vision side, the output from the third IF stage is passed to a D₄₃ valve for demodulation, and thence through a KTZ41 to the cathode ray tube. Separate diodes in conjunc-

programmes relayed through Alexandra Palace, without working the vision side of the receiver.

In two of the new receivers, the picture size is 6½ in. x 8½ in. They are the table Model 1800 at 31 guineas, and the console Model 1801 at 36 guineas. A 14-inch tube giving a picture 9½ in. x 11½ in. is used in the Model 1802 console at 44 guineas, and the Model 1850 at 57 guineas.

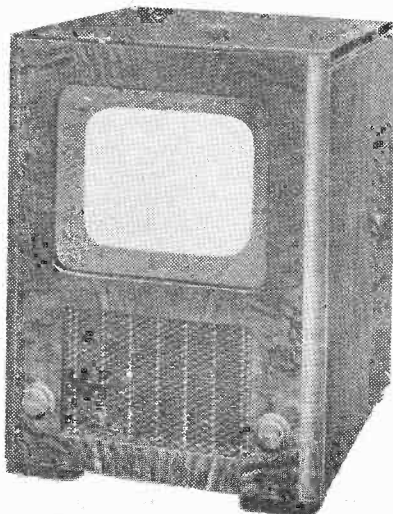

H.M.V. table Model 1800 with 10-inch tube and console Model 1802 with 14-inch tube. Provision is made for using the sound side separately for high-quality reception.

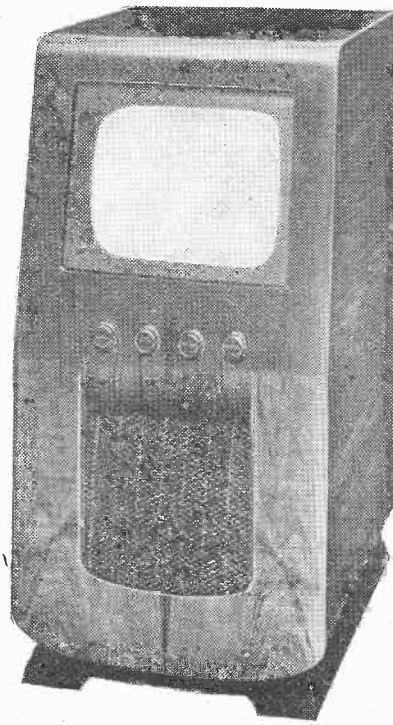

tion with KTZ63 valves act as sync. separators. Separate power supply units are provided for the sound and vision circuits, so that the receivers may be used for high-quality reception of

The latter includes an all-wave push-button receiver with AFC.

The existing Models 905, 907 and 900 are being continued.

UNBIASED

"Cathode Ray" Solves a Mystery

I WAS exceptionally interested in the recent article by "Cathode Ray" in which he expounded the mysteries of the transatlantic telephone, as it clears up another mystery existing in my own household, which has worried me for many years past, almost, in fact, since the day when the transatlantic telephone was inaugurated.

It so happens that Mrs. Free Grid has a sister living in America, not because her family is American, but because many years ago she—the sister I mean—entrapped some unfortunate citizen of the U.S.A. into a promise of marriage at a time when he was just recovering from the effects of a very bad crossing, and was probably feeling like death warmed up, and hadn't a kick left in him.

At any rate, whatever be the reason for this strange lapse on the part of a member of a nation of people who pride themselves on their mental alertness, she has for many years past been installed in the U.S.A., and is doubtless responsible for a good deal of the strange ideas which the Americans have concerning our mode of life over here. The point is that about once a week Mrs. Free Grid rings her up on the phone, and what I have never hitherto been able to understand is that the conversation simply develops into a long, unbroken monologue on the part of Mrs. Free Grid, her sister, apparently, not being able to get a word in edgeways. Now my sister-in-law is only slightly less well endowed with conversational powers than my wife, and I failed to see why the weekly contests should have developed into such one-sided affairs.



Mrs. Free Grid and —

The whole thing is, of course, quite clear now, after Cathode Ray's explanation. The power used in the transatlantic phone is so great that if something were not done a vicious feed-back circle would be established between transmitter and receiver on the same side of the Atlantic, and continuous howling would occur. This is prevented by making each speaker's voice operate a relay which breaks the circle by opening the neighbouring receiver circuit. In effect, therefore, as long as a person

continues to speak, the transatlantic telephone is a one-way affair, and the unfortunate wretch at the other end has no chance to butt in.

This, of course, is precisely what happens in the case of Mrs. Free Grid and her sister. Mrs. Free Grid certainly has no flies on her, as her American brother-in-law once told me, and what she does after she has rung up is to get her spoke in first, and since she scarcely pauses for breath once she has started, her unfortunate sister can't get a word in edgeways. I have sent a marked copy of the *Wireless World* containing Cathode Ray's article across the Atlantic, together with a few anonymous explanatory notes, and am now awaiting developments.

Is Remote Control Wanted?

I HAVE just been having an interesting correspondence with a reader on the subject of remote control. He was roused to write to me in the first place because of what he claimed to be my obvious ignorance of the goings-on in that strange underworld in which wireless manufacturers live and have their being. His claim to special knowledge lies in the fact that he is acquainted with a girl who winds coils in one of our big wireless factories, and she, so he claims, is in a position to be in the know. This may not seem a very reliable source of knowledge to you, but, all the same, it is surprising what some factory girls do know, and I am not at all sure that there may not be something in what this particular correspondent tells me.

In the first place, he takes me to task for prophesying that manufacturers will be bringing out remote control receivers galore because there is a strong public demand for them. He argues that there is no more a public demand for them than there was for broadcasting itself in the days before it started. It was, he states, the manufacturers who created the demand for broadcasting by forming the old British Broadcasting Company in 1922, and starting to broadcast programmes. Coming to more recent times, my correspondent alleges that there was never any outcry or demand among listeners to be given the advantages of push buttons. It was only after they had been given them that they realised their advantages, and took to them.

As a truthful man, I must admit that my correspondent is right in the above statement, and quite frankly, told him so, but I ventured to disagree with him when he said that even if there were a public demand for anything, manufacturers would ignore it. Much as it went against the grain, I felt compelled to rush to the

By FREE GRID

defence of the manufacturers, and in a somewhat heated reply, pointed out that they would most certainly market anything for which there was a public demand, as it would be in their interests to supply goods to a market which was already waiting for them. My correspondent, however, countered by citing numerous instances in which the manufacturers had failed to satisfy a very strong public demand, and, in addition, he stated that everybody in the manufacturing world knew that public demand was fickle and unreliable. Being a technical man, I promptly refused to argue with him on non-technical subjects, and so closed the correspondence.

Personally speaking, I am all in favour of remote control, my only objection to it being that it is, after all, still necessary to push a button bearing the name of the



—her sister.

station you want to listen to. I should have thought that as a result of all the experimental work which must have been put into the development of the voice-operated relays in the transatlantic telephone, about which I have just been talking in connection with Mrs. Free Grid and her sister, radio engineers would have found it easy to produce some sort of voice-operated system of tuning. I personally cannot see any fundamental difficulty in the way; it is merely a question of perfecting details; and, after all, difficulties are only sent into the world to be overcome. None of you can deny that it would be exceedingly pleasant to sit back in your armchair and tune in by bawling out the name of the station you want to receive.

I dare say, however, that the scheme would be abused, and some of you idle rich would take to having a footman standing at your chairside to do the bawling. However, probably some of you of a more technical turn of mind than the average have your own ideas on the subject and could probably devise some method whereby we poorer folk could dispense with the necessity of shouting without having to go to the expense of a footman.

Recent Inventions

DIRECTION AND ELEVATION FINDER

IF two dipole aerials, spaced apart by a distance greater than the working wavelength, are rotated about a common centre, the arrangement will give more than two minimum readings when directed on to a transmitter carried by an aeroplane.

The signals picked up on each dipole may either be added together or subtracted, and the incidence of each minima is automatically recorded, during each rotation, on a circular scale in combination with timing marks.

From the record so formed it is possible to determine the elevation of the aeroplane as well as its direction in azimuth.

H. A. Thomas. Application date October 22nd, 1937. No. 504293.

IMPROVED SCANNING SYSTEM

ONE obvious way to improve the detail of a televised picture is to increase the number of scanning lines at the transmitting end. But in most cases this would mean considerable alteration to the standard type of receiving set. The scheme now proposed secures better definition without increasing the number of scanning lines, by reducing the size of the scanning spot to less than the width of the scanning line, and making the spot move in a curved instead of a straight path.

Fig. 1 shows the spacing of successive lines, A, B, C in a "straight" scanning system, the shaded curve being the track covered by a spot of half the usual diameter moving along a curved path as already mentioned. Fig. 2 shows the result of increasing the frequency at which the spot

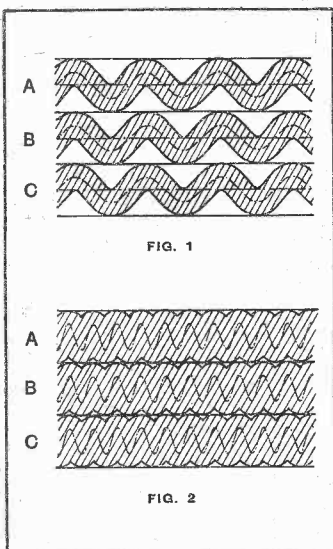

Oscillating scanning spot to increase definition.

of light is oscillated as it moves forward. It will be seen that the whole width of each scanning line is now substantially covered, whilst the resolving power of the spot, say, on a sharp edge separat-

ing black from white, has been increased. A similar oscillating movement is given to the scanning spot at the receiving end by transmitting suitable synchronising impulses. Pictures so transmitted can be received on a standard type of set without loss of definition, though to secure the full benefit of the invention a special receiver should be used.

A. D. Blumlein. Application date 14th October, 1937. No. 503555.

DETECTING ULTRA-SHORT WAVES

THE figure shows a highly-sensitive circuit for receiving ultra-short waves. The signals are picked up by two dipoles D, D₁, which are mounted partly inside and partly outside an evacuated tube T. The dipoles are joined together by a fine barettor wire W, which is heated by the received energy. This barettor wire may be pre-heated by an auxiliary battery in order to increase its resistivity to the re-

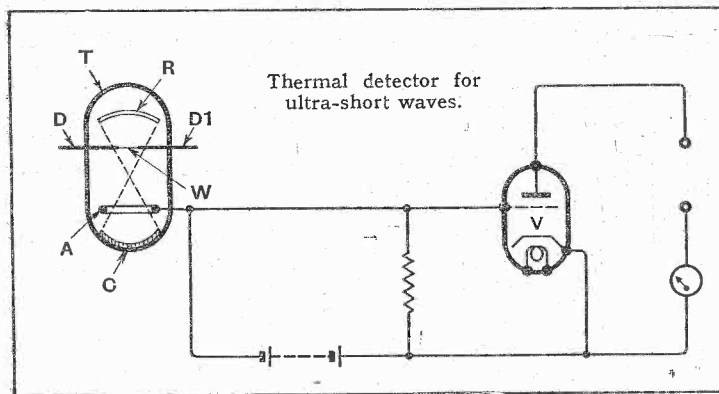

ceived signal current. The heat so produced is projected on to a photo-sensitive cathode C, a reflector R being mounted on the other side of the wire to assist this process.

The resulting emission from the cathode C is collected by a positively charged anode A which is made in the form of a wide-meshed grid in order not to screen the cathode from the heat radiated by the barettor wire. The photo-electric current so collected is finally amplified by a valve V. Telefunken ges. für drahtlose Telegraphie m.b.h. Convention date (Germany), 3rd November, 1936. No. 504836.

TELEVISION SYSTEMS

THE object of the invention is to allow a higher degree of amplification to be applied to the picture signals in a television transmitter without increasing the difficulty of separating them out from the synchronising impulses at the receiving end. The improve-

Brief descriptions of the more interesting radio devices and improvements issued as patents will be included in this section.

ment is based on the fact that it does not matter, so far as the subsequent separation of the signals is concerned, if the amplitude of the picture signals is increased during the first part of each scanning line, provided that, at the end of the line, the relative amplitude of the picture and synchronising signals is brought back to a fixed level.

Accordingly, by increasing the amplitude of the picture signals during the first part of each scanning line and then bringing it back to a fixed level towards the end of the line, the "overall" picture amplification can be considerably increased without causing trouble when the signals come subsequently to be separated. The desired result is secured by using a form of auto-

effective capacity is known to vary with the value of the applied voltage. The layer may be made of copper or zinc oxide, or it may consist of an electrode covered with a coating of selenium.

The figure shows a typical

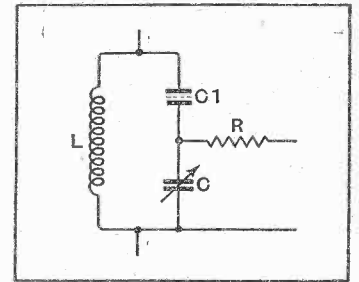

Circuit arranged for tuning control by voltage variations.

arrangement in which the "blocking-layer" condenser C₁ is inserted in series with a tuned circuit L, C. The effective tuning of the circuit will then depend upon a control voltage, which is applied through a resistance R and may be derived either from the ATC stage of the set, or from a distant point. Suitable precautions are taken to prevent the "blocking-layer" condenser from damping the tuned circuit, or from acting as a short-circuit.

N. V. Philips Gloeilampenfabrieken. Convention date (Switzerland), 1st May, 1937. No. 501238.

CUTTING OUT INTERFERENCE

IN order to minimise local interference it is usual to erect the aerial as high above ground as possible, and couple it to the receiver by a screened downlead or a pair of "crossed" feed-lines. In practice, however, owing to imperfect shielding and lack of symmetry, some of the interference generally gets into the set via the downlead. Also, since it is difficult to place the aerial at a sufficient height to be outside the field of interference, a certain amount of disturbance will enter the receiving set in this way.

According to the invention, the downlead or transmission line is deliberately "unbalanced" in such a way that any disturbance picked up by the line is made to oppose and balance that picked up by the aerial. In practice the two feed-lines are shunted by a potentiometer, one end of which is connected to earth through a variable capacity, whilst a second earth connection is made through a variable tap on the potentiometer.

Marconi's Wireless Telegraph Co., Ltd. (assignees of V. D. Landon). Convention date (U.S.A.) October 31st, 1936. No. 504752.

The British abstracts published here are prepared with the permission of the Controller of H.M. Stationery Office, from Specifications obtainable at the Patent Office, 25, Southampton Buildings, London, W.C.2, price 1/- each

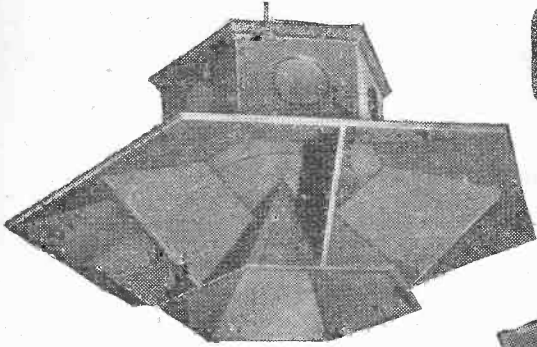

GOODMANS CONCENTRIC DIFFUSER P.A. LOUDSPEAKER

GOODMANS Concentric Diffuser meets the demand for a compact Reproducer of high-power handling capacity and having non-directional properties. Of unorthodox hexagonal double baffle design with radial partitions. Due to the cellular effect of these dividing partitions an exceptionally wide diffusion of high notes is obtained. A single Concentric Diffuser Loudspeaker may be substituted for a number of standard Loudspeakers, thus reducing interference due to echo effects.

Power-handling capacity: 20 Watts A.C. Peak.
Speech Coil impedance: 15 ohms.
Finish: Brown Enamel.
Size: 36ins. x 18ins.
Price £15.0.0

GOODMANS

P.A. LOUDSPEAKERS for EVERY purpose !

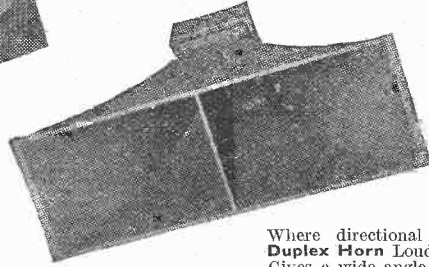

GOODMANS DUPLEX HORN LOUDSPEAKER

Where directional properties are desirable the Duplex Horn Loudspeaker is the ideal solution. Gives a wide angle of propagation, equaling two horns set at an angle to each other.
Power-handling capacity: 15 Watts A.C. Peak.
Speech Coil impedance: 15 ohms.
Length of horn: 2ft. 10ins.
Width of horn: 2ft. 11ins.
Finish: Battleship Grey.

GOODMANS P12 E. & 12 P.M. P.A. LOUDSPEAKERS

(Incorporating Detachable Diaphragm)

High quality P.A. Reproducers capable of handling up to 20 Watts A.C. Peak they are characterised by clear-cut speech and full-bodied rendering of Orchestral and Band items.
Speech Coil impedance: 15 ohms.
Overall diameter of chassis: 13 1/2 ins.
Depth: P.M. Model, 7 ins.
Energised Model, 7 1/2 ins

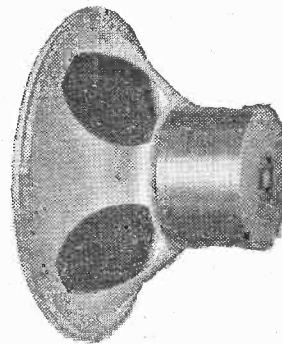

PERMANENT
MAGNET MODEL £6.15.0
ENERGISED
MODEL £4.10.0

GOODMANS INDUSTRIES, LTD.

Lancelot Road, Wembley, Middx. Phone, WEMbley 4 001.

STAND No. 19
RADIOLYMPIA

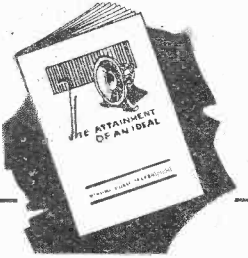

SEND FOR THIS FREE TECHNICAL BROCHURE giving valuable technical information and data on the principles of Loudspeaker construction.

To
GOODMANS INDUSTRIES LTD.
Lancelot Road, Wembley, Middlesex.
Phone: WEMbley 4001
Please send me a copy of your 20-page Booklet, "The Attainment of an Ideal." I enclose 1/6d. towards postage

Name.....
Address.....
.....
.....

Attach this to your card or letterheading.
W.W. 3.8.39.

IDENTIFICATION PARADE

Is the call sign W2XAD or W2XGB?

It is often difficult to distinguish call signs which sound alike, especially when atmospheric conditions make reception difficult on the short waves. There is no need to wait for the call sign to be repeated or leave the station without knowing its origin. "World-Radio" is a quick reference guide for foreign programme enthusiasts. It gives

programmes hour by hour for each day of the week, and it takes only a few seconds to check the programme you are receiving.

"World-Radio" is the ideal programme-choosing paper for "Wireless World" readers; they should all also have a regular weekly copy of

World-Radio

THREEPENCE EVERY FRIDAY
FROM ALL NEWSAGENTS AND BOOKSTALLS

Mention of "The Wireless World," when writing to advertisers, will ensure prompt attention.

The
**Wireless
World**

CLASSIFIED ADVERTISEMENTS

NOTICES

THE CHARGE FOR ADVERTISEMENTS in these columns is

12 words or less, 3/- and 3d. for every additional word.

Each paragraph is charged separately and name and address must be counted.

SERIES DISCOUNTS are allowed to Trade Advertisers as follows on orders for consecutive insertions, provided a contract is placed in advance, and in the absence of fresh instructions the entire "copy" is repeated from the previous issue: 13 consecutive insertions 5%, 26 consecutive, 10%; 52 consecutive, 15%.

ADVERTISEMENTS for these columns are accepted up to **FIRST POST** on **MONDAY MORNING** (previous to date of issue) at the Head Offices of "The Wireless World," Dorset House, Stamford Street, London, S.E.1, or on **SATURDAY MORNING** at the Branch Offices, 8-10, Corporation Street, Coventry; Guildhall Buildings, Navigation Street, Birmingham, 2; 260, Deansgate, Manchester, 3; 26a, Renfield Street, Glasgow, C.2.

Advertisements that arrive too late for a particular issue will automatically be inserted in the following issue unless accompanied by instructions to the contrary. All advertisements in this section must be strictly prepaid.

The proprietors retain the right to refuse or withdraw advertisements at their discretion.

Postal Orders and Cheques sent in payment for advertisements should be made payable to **ILLIFFE & SONS Ltd.**, and crossed **& Co.** Notes being untraceable if lost in transit should not be sent as remittances.

All letters relating to advertisements should quote the number which is printed at the end of each advertisement and the date of the issue in which it appeared.

The proprietors are not responsible for clerical or printers' errors, although every care is taken to avoid mistakes.

IMPORTANT NOTICE.

Owing to the August Bank Holiday the issue of "THE WIRELESS WORLD" for August 10th must be closed for press earlier than usual.

CLASSIFIED ADVERTISEMENTS for insertion in that issue can be accepted up to

FIRST POST FRIDAY, AUGUST 4th.

NEW RECEIVERS AND AMPLIFIERS

*
*
CHALLENGER RADIO CORPORATION "Degallier's." Send 2d. stamp for handsome illustrated catalogues telling of our superb range of fully guaranteed receivers; direct to public sales policy saves you 40%; sets to suit every pocket from 65/- to £31/10. Sale list also available upon request.—Challenger Radio Corporation, "Degallier's," 31, Craven Terrace, London, W.2. Paddington 6492. Nearest point, Lancaster Gate Tube. [8731]

RADIO CLEARANCE, Ltd.

ALL Lines Previously Advertised Still Available.

ALL Orders Over 5/- Carriage Free; under this amount sufficient postage must be included with order.

ALL Enquiries Must Enclose 1½d. Stamp.

RADIO CLEARANCE, Ltd., 65, High Holborn, W.C.1. Holborn 4631. [8774]

ARMSTRONG Co.—After many years at our old premises at Camden Town we have moved to a new building in Warlters Rd., Holloway, N.7 (see displayed advertisement).

ARMSTRONG Amplifier Division Has Moved to New Premises at 94, Camden Rd., N.W.1. In addition to our standard range of 6- and 12-watt push-pull high fidelity amplifiers and local station feeder units, we manufacture equipment for special purposes, pre-stage units, electronic mixers, tone control units, etc.

ARMSTRONG Are Always Pleased to Assist in the Solution of Special Problems; details of standard equipment free on request.

ARMSTRONG Co. (Amplifier Division), 94, Camden Rd., N.W.1. [8752]

The **LITTLE METER** that does the

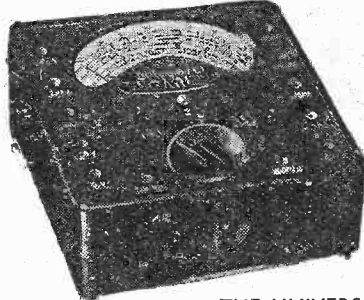

**BIG
JOBS**

THE UNIVERSAL

AVOMINOR

Regd. Trade Mark

BRITISH MADE.

ELECTRICAL MEASURING INSTRUMENT

D.C. VOLTAGE
0-75 mv. 0-100 v.
0-5 v. 0-250 v.
0-25 v. 0-500 v.

A.C. VOLTAGE
0-5 v. 0-100 v.
0-25 v. 0-250 v.
0-500 v.

D.C. CURRENT
0-2.5 ma. 0-25 ma.
0-5 " 0-100 "
0-500 "

RESISTANCE
0-20,000 ohms
0-100,000 "
0-500,000 "
0-2 megohms
0-5 "
0-10 "

Weighing only 18oz. and measuring but $4\frac{1}{2} \times 3\frac{1}{2} \times 1\frac{1}{2}$ ", this is a really portable meter of high accuracy for measuring A.C. & D.C. volts, D.C. milliamperes and ohms. An accurate moving-coil movement gives a 3" full scale deflection. Total resistance is 200,000 ohms. Complete with instruction booklet, leads, interchangeable testing prods and crocodile clips.

£5.10. (leather case 10/-)

DEFERRED TERMS IF DESIRED

Write for descriptive pamphlet

Sole Proprietors & Manufacturers:—
The Automatic Coil Winder & Electrical Equipment Co., Ltd.,
Winder House, Douglas Street,
London, S.W.1. Phone: Victoria 3404/7

**GET 2 YEARS FREEDOM
FROM NEEDLE CHANGING**
with the

Walco **GENUINE
Sapphire**

GRAMOPHONE NEEDLES

More than 2,000 playings from one needle, a minimum of record wear, and greatly improved reproduction are obtained from the new Walco Needle—price 12/-.
Order now or write for **FREE BOOKLET "SOUND REPRODUCTION"** from

R.A. Rothermel

(Dept. G)

Canterbury Road, High Road, Kilburn, N.W.5

For details of the **NEW 1940 RANGE** of

ARMSTRONG CHASSIS

See **AUGUST 17th "Wireless World"**
SOMETHING REALLY GOOD

Look out for it!

ARMSTRONG MANUFACTURING CO.
Warlters Road, Holloway, London, N.7.
Phone: NORth 3213

NUMBERED ADDRESSES

For the convenience of private advertisers, letters may be addressed to numbers at "The Wireless World" Office. When this is desired, the sum of 6d. to defray the cost of registration and to cover postage on replies must be added to the advertisement charge, which must include the words Box 000, c/o "The Wireless World." All replies should be addressed to the Box number shown in the advertisement, c/o "The Wireless World," Dorset House, Stamford Street, London, S.E.1. Readers who reply to Box No. advertisements are warned against sending remittances through the post except in registered envelopes; in all such cases the use of the Deposit System is recommended, and the envelope should be clearly marked "Deposit Department."

DEPOSIT SYSTEM

Readers who hesitate to send money to advertisers in these columns may deal in perfect safety by availing themselves of our Deposit System. If the money be deposited with "The Wireless World," both parties are advised of its receipt.

The time allowed for decision is three days, counting from receipt of goods, after which period, if buyer decides not to retain goods, they must be returned to sender. If a sale is effected, buyer instructs us to remit amount to seller, but if not, seller instructs us to return amount to depositor. Carriage is paid by the buyer, but in the event of no sale, and subject to there being no different arrangement between buyer and seller, each pays carriage one way. The seller takes the risk of loss or damage in transit, for which we take no responsibility. For all transactions up to £10, a deposit fee of 1/- is charged; on transactions over £10 and under £50, the fee is 2/6; over £50, 5/-. All deposit matters are dealt with at Dorset House, Stamford Street, London, S.E.1, and cheques and money orders should be made payable to Illiffe & Sons Limited.

SPECIAL NOTE.—Readers who reply to advertisements and receive no answer to their enquiries are requested to regard the silence as an indication that the goods advertised have already been disposed of. Advertisers often receive so many enquiries that it is quite impossible to reply to each one by post. When sending remittances direct to an advertiser, stamp for return should also be included for use in the event of the application proving unsuccessful.

NEW RECEIVERS AND AMPLIFIERS

AMAZING Offer.—Famous 7-valve push button 1939 models in makers sealed cartons, issued 13½ gns.; £5/19/6; list free.—Shippers, 18, Corporation St., Manchester. [0639]

USED SETS FOR SALE

HALLICRAFTER

HALLICRAFTERS "Sky Chief" Communication Receiver, condition new, guaranteed; first offer over £6/10.—H. Barnett, 2, Church St., Evesham. [8759]

Wanted

WANTED.—W.W.S.S. or Q.A. super receiver.—Heal, 21, Wall Lane Terrace, Cheddleton, Staffs. [8768]

CAR RADIO

ALL Goods Previously Advertised Still Available.

HENRYS, 72, Wellington Ave., Stamford Hill, N.15. Stamford Hill 2907. [8745]

1939 Models from 4½ gns.; 6 new car aerials, from 9/6; trade enquiries solicited; lists free.—Shippers, 18, Corporation St., Manchester. [0622]

PUBLIC ADDRESS

V

VORTEXION P.A. Equipment.

IMITATED, but unequalled.

WE Invite You to a Demonstration.

A.C.D.C. Dance Band Amplifier, 10 watts output, complete in case, with moving coil microphone, speaker and cables, weight 22lb.; 12 gns.

A.C. 20 15-20-watt Amplifier, 38-18,000 cycles, independent mike and gram. inputs and controls, 0.037 volts required to full load output for 4 7.5, and 15 ohms speakers or to specification inaudible hum level, ready for use; 8½ gns., complete.

C.P. 20 12-volt battery and A.C. Mains Model, as used by R.A.F. output as above; 12 gns.

A.C. 20, in portable case with Collard motor, Piezo pick-up, etc., £14; C.P.20 ditto, £17/17.

50-WATT Output 6L6s, under 60-watt conditions, with negative feed back, separate rectifiers for anode screen and bias, with better than 4% regulation level response, 20-25,000 cycles, excellent driver, driver transformer, and output transformer matching 2-30 ohms impedance electronic mixing for mike and pick-up with tone control, complete with valve and plugs; £15.

(This advertisement continued on next page.)

PUBLIC ADDRESS

(This advertisement continued from previous page.)

COMPLETE in Case, with turntable, B.T.H. Piezo pick-up and shielded microphone transformer; £20.

80-WATT Model, with negative feed back; £25, complete.

120-WATT Model, with negative feed back; £40, complete.

250-VOLT 250 m.a. Full Wave Speaker field supply unit; 25/-, with valve.

ALL P.A. Accessories in Stock, trade supplied.

VORTEXION, Ltd. 182, The Broadway, Wimbledon, S.W.19. Phone: Lib. 2814. [8241]

"PARTRIDGE P.A. Manual," standard handbook on electro-acoustics, amplifiers, and audio circuits; price 2/6 (free to trade).

"PARTRIDGE Amplifier Circuits," describes many modern constructional amplifiers, 2w. to 45w. output, battery, A.C.-D.C., etc.; price 2/- (no free copies).

PARTRIDGE, N. B.Sc., A.M.I.E.E., King's Buildings, Dean Stanley St., London, S.W.1. [0630]

ALEXANDER BLACK, Ltd., pioneers of hiring microphone amplifying equipment since 1928. Booklet on request.—55, Ebury St., S.W.1. Sloane 6129. [0598]

PUBLIC Address Contractors Can Hire P.A. Vans, loud speakers, microphones and equipments of all types from Hire Dept., Gramplan Reproducers, Ltd., Kew Gardens, Surrey. Tel.: Richmond 1175-6-7. [0618]

Wanted

WEBSTER Battery Amplifier Model MV-410, new or second hand, without microphone or speaker.—EIGJ, Cavan, Eire. [8767]

15 WATT Amplifier for Speaking, clarity essential, microphone to suit, four permanent magnet moving-coil speakers.—Johncock, 35, Headfort Place, S.W.1. [8757]

NEW MAINS EQUIPMENT

VORTEXION Mains Transformers, chokes, etc., are supplied to G.P.O., B.B.C., L.P.T.B. Why not you?

VORTEXION, Ltd., 182, The Broadway, Wimbledon, London, S.W.19. Telephone: Liberty 2814. [8772]

NEW LOUD-SPEAKERS

SINCLAIR Speakers for All Types.—Pulteney Terrace, Copenhagen St., N.1. [0603]

BAKERS New Corner Horn Speakers, Triple cone conversions; from 29/6, and surplus speaker bargains.—Bakers Selhurst Radio, 75, Sussex Rd., South Croydon. [8728]

LOUD-SPEAKERS

SECOND-HAND, CLEARANCE, SURPLUS, ETC.

VOIGT Twin Diaphragm Unit with Whitewood Corner Horn and Field Supply Rectifier; £20.—Dixon, Honiton House, Hamilton Rd., Reading. [8755]

3,000 Speakers from 5/6 each, P.M. and energised 4in. to 14in., including several Epoch 18in.—Sinclair Speakers, Pulteney Terrace, Copenhagen St., N.1. [0591]

VOIGT Corner Horn Speaker in the White, latest laboratory diaphragm and filter, built in 460v. field supply, complete; £25.—Allworth, 20, Purley Bury Close, Purley. [8726]

Wanted

WANTED—Haynes Senior Standard Speaker, fields 2,500 and 7,500 ohms, and output transformer type OPP 15; also duophase balanced coupler.—Smith, Highlands, Windmill Lane, Wightwick, Wolverhampton. [8756]

TELEVISION

H.M.V. 29 Gns. All-wave Receiver, as new; £20.

HENRYS, 72, Wellington Ave., Stamford Hill, N.15. Stamford Hill 2907. [8746]

"MURPHY" Television, as new, under guarantee; £26.—Box 653, c/o The Wireless World. [8769]

TRANSMITTING APPARATUS

A.C.S. RADIO, specialists in short wave apparatus, communication receivers, including Hallicrafters, National and R.M.E. transmitting equipment, valves and components. Send for free catalogue to A.C.S. Radio, 16, Gray's Inn Rd., W.C.1. Holborn 9894-5. G2NK, Technical Manager. [0550]

G5NI.—The oldest and largest distributor of amateur equipment transmitting and receiving; short-wave catalogue, 150d. G5NI 70-page Manual, 75d., post free; authorised direct distributor for Collins, National, R.M.E., Thordarson, Hammerlund, Biley, Taylor, Elmac, etc., etc.—44, Holloway Head, Birmingham. [0531]

CABINETS

A CABINET for Every Radio Purpose.

CONVERT Your Set into a Radiogram at Minimum Cost; surplus cabinets from noted makers under cost of manufacture (undrilled); 30/- upwards; motors at wholesale prices.

"FIT-A-GRAM" Cabinet, 31x17x15; 21/-.

UNDRILLED Table Console and Loud-Speaker Cabinets from 3/6.

INSPECTION Invited; photos loaned to country customers.

H. L. SMITH and Co., Ltd., 289, Edgware Rd., W.2. Tel.: Pad. 5891. [0485]

PREMIER RADIO STOCKTAKING SALE FINAL SALE OFFERS!

BATTERY CHARGERS for A.C. Mains, 2 volts, 1/2 amp. Metal Rectification, 10/-.
 POTENTIOMETERS WITH SWITCH, 1/2 meg., 1 meg., 20,000 ohms and 10,000 ohms, 1/3 each.
 POTENTIOMETERS WITHOUT SWITCH, 2 meg., 1 meg., 1/2 meg., 400,000 ohms, 25,000 ohms, 20,000 ohms, 10,000 ohms, 1/- each.
 SPECIAL OFFER—CONTINENTAL MAINS VALVES, 4 v. AC Types, 5-pin only, AC/HL, AC/L, AC/P, AC/SG, AC/VMS, AC/HP, AC/VHP, 2/6 each.
 F.W. RECTIFIERS. 350v. 120ma. 4/6; 500v. 120 ma. 5/6.
 20 v. 18a AC/DC Types, SG. Var. Mu., SG. Power, HF Pen., 2/- each.
 U.S.A. Types, 24, 30, 41, 39/44, 35/51, 55, 56, 57, 58, 71, 77, 78, 85, 2A5, 2A6, 2A7, 2B7, 6A7, 12Z3, 210, 250, all 2 for 3/-.
 TUBULAR CONDENSERS, .002, .0001, .0003 and .0005 mfd., 1/- doz. Your choice.
 ELECTROLYTIC CONDENSERS. Metal Can. 8 mfd. 320 volts, 2 for 1/6. 8+8 mf. 475 v.+10 mf. 50 v., 2 for 2/6. 8+8 mf. 450 v.+8 mf. 250 v., 2 for 2/6.
 T.C.G. DRY ELECTROLYTICS. 8+8+4 mf. 500 v., 2/- each.
 500 v. CARDBOARD ELECTROLYTICS. 4 mf. or 8 mf., 1/6. 8+4 mf., 2/9. 8+8 mf., 2/6. 4+4 mf., 2/4.
 MAINS TRANSFORMERS — MANUFACTURERS' SURPLUS. 250—250 v. 60 ma., 4 v. 2 a., 13 v. 1 a., 3/6.
 GARRARD AUTO CHANGERS, Model RC.4 for A.C. Mains, 250-250 v., plays eight 10" or 12" Records. Limited quantity only to clear at £5.5.0.

Huge Reduction in Prices of TRIAD U.S.A. VALVES

from 2/3 each!

Send for NEW Price List.

PREMIER SHORT-WAVE KITS.

Complete to the last detail including all Valves and coils, as well as theoretical and wiring diagrams and lucid instructions for building and working. Each kit is supplied with a steel Chassis and Panel and uses plug-in coils to tune from 13 to 170 metres.
 1 Valve Short-Wave Receiver or Adapter Kit ... 17/6
 1 Valve Short-Wave Superhet Converter Kit ... 22/6
 1 Valve Short-Wave A.C. Superhet Converter Kit ... 22/6
 2 Valve Short-Wave Receiver Kit ... 25/-
 3 Valve Short-Wave Screen Grid and Pentode Kit ... 58/6
 PREMIER U.S.A. QUARTZ TRANSMITTING CRYSTALS
 7 mc Band, 10/- each, with Calibration Certificate. Enclosed holder and base, 3/-.
 MORSE KEYS. Excellent brass movement on bakelite base, 2/9 each.
 PREMIER SHORT-WAVE COILS, 4- and 6-pin types, 13-26, 22-47, 41-94, 78-170 metres, 1/9 each, with circuit. Special set of S.W. Coils, 14-150 metres, 4/- set, with circuit. Premier 3-band S.W. coil, 11-25, 19-43, 38-86 metres. Suitable any type circuit, 2/6.
 UTILITY Micro Cursor Dials, Direct and 100:1 Ratios, 3/9.
 PREMIER Short-Wave Condensers, all-brass construction, with Trolital insulation. 15 mmf., 1/6; 25 mmf., 1/7; 40 mmf., 1/9; 100 mmf., 2/-; 160 mmf., 2/3; 250 mmf., 2/6.
 TROLITAL DOUBLE SPACED TRANSMITTING CONDENSERS. 15 mmf., 2/9; 40 mmf., 3/6; 100 mmf., 4/-; 160 mmf., 4/6.
 COIL FORMERS, 4- or 6-pin low-loss, 1/- each. Orders 5/- and over sent Post Free. Under 5/- please add 6d. Postage.

NOW READY. PREMIER 1940 CATALOGUE. 112 illustrated pages. Over 20 pages of British and American Valve Data. Bigger and Better than Ever! 6d. per copy. "CLASS B" KITS, comprising driver transformer, 2 volt Class B Valve and holder, with circuit. 10/- complete.
 MAGNAVOX 8" P.M. MOVING COIL SPEAKERS, with Output Transformer, 10/6 each.

ALL POST ORDERS TO: Jubilee Works, 167, Lower Clapton Road, London, E.5. Amherst 4723.
 CALLERS TO: Jubilee Works, or our NEW PREMISES, 169, FLEET STREET, E.C.4. Central 2833.
 or 50, High Street, Clapham, S.W.4. Macaulay 2381

TRADE SERVICE
 Get in touch with us for
 Steel or Aluminium chassis, Oxy. welding, Spot welding, Stove enamelling, Chokes, Transformers, Tuning Units, R.F. Coil Winding in matched sets, Receiver and Amplifier chassis, Quartz Crystals, etc., etc.
 We invite your enquiries for general lathe work and any form of light engineering.
 JOHN MCCLURE LTD. (G6JMI)
 ERSKINE ROAD, LONDON, N.W.3. BRIDGE 5435

DYNAMOS, MOTORS, ETC.

ALL Types of Rotary Converters, electric motors, battery chargers, petrol-electric generator sets, etc., in stock, new and second-hand.

A.C.-D.C. Conversion Units for Operating D.C. Receivers from A.C. Mains, 100 watts output, £2/10; 150 watts output, £3/10.

WARD, 46, Farringdon St., London, E.C.4. Tel.: Holborn 9703. [0518]

RECORDING EQUIPMENT

PHONO-DISC Recording Gramophone with Microphone; bargain, £17.—Millar, 7, Park Lane, W.1. [8754]

ALL Recording Discs and Materials in Stock, tracker units, £4/7/6; recording motors, £3/17/6.—Write for further details, Will Day, Ltd., 19, Lisle St., W.C.2. [0595]

FEIGH Recording Sets are Within Reach of All; ball bearing gear box, worm drive traverse; records on any disc, Morse, speech or music; diamond cutter-pickup on tone arm, the set 37/6; 6in. blanks, 3/3 doz.; 10in. discs, 7/- doz.—Electradix, 218, Upper Thames St., London, E.C.4. [0620]

VALVES

ALL Types of American Tubes in Stock of Impex and Arcturus makes at competitive prices.

WE Can Also Supply a Full Range of Guaranteed Replacement Valves for Any British non-ring, American or Continental type at an appreciably lower price.

SEND for Lists of These, and also electrolytic condensers, line cords, resistances, etc.

CHAS. F. WARD, 46, Farringdon St., London, E.C.4. Tel.: Holborn 9703. [0452]

AMERICAN, 2/9; 1,000 non-ring British from 1/9; bargain galore; lists free.—Shippers, 18, Corporation St., Manchester. [0607]

METROPOLITAN RADIO SERVICE.—Special offer, American valves, in makers' cartons, 3/- each, Octals, 3/6 each; American valves, first grade, in all types; trade supplied.—1021, Finchley Rd., N.W.11. Speedwell 3000. [0436]

ELECTRICAL EQUIPMENT

1- and 3-phase Motors, 1/4 to 5 h.p., surplus stock, first class condition.—Tel.: Reliance 1693. Easco Electrical Service, 18, Brixton Rd., S.W.9. [0642]

COMPONENTS

SECOND-HAND, CLEARANCE, SURPLUS, ETC.

RADIO CLEARANCE, Ltd.

ALL Lines Previously Advertised Still Available.

ALL Orders Over 5/- Carriage Free; under this amount sufficient postage must be included with order.

ALL Enquiries Must Enclose 1/2d. Stamp.

RADIO CLEARANCE, Ltd., 63, High Holborn, W.C.1. Holborn 4631. [8773]

PREMIER SUPPLY STORES.

PLEASE See Our Displayed Advertisement on this page. [0488]

GOODS Previously Advertised Still Available.—Ryall's Radio, 280, High Holborn, London, W.C.1. [8709]

VAUXHALL.—All goods as previously advertised still available; write for free list.—Vauxhall Utilities, 165a, Strand, W.C.2. [8727]

SOUTHERN RADIO, 46, Lisle St., London, W.C. Ger-rard 6653.—Stocks of receivers and replacement components, as previously advertised. [8548]

MAINS RADIO DEVELOPMENT Co. Offer all Exclusive Bargains as last week; stamp for list 22/- 4 and 6, Muswell Hill Rd., London, N.6. [8759]

REPAIRS AND SERVICE

"SERVICE with a Smile."

AMERICAN Valves, spares, linecords, rewinds, repairs of all types of American and British receivers.—F.R.L., Ltd., 22, Howland St., W.1. Museum 5675. [0434]

LOUD-SPEAKER Repairs, British, American, any make, 24-hours' service; moderate prices.—Sinclair Speakers, Pulteney Terrace, Copenhagen St., N.1. [0590]

GUARANTEED Repairs, Any Transformers, choke, motor armature, converter, dynamo, etc., keenest prices, immediate quotation, prompt, dependable service.—See below.

L.T.P. (LONDON TRANSFORMER PRODUCTS, Ltd.), Willesden, N.W.10. Willesden 6486 (3 lines). [6992]

MAINS Transformer Service, Repairs, rewinds, or construction to specification of any type, competitive prices and prompt service.—Sturdy Electric Co., Dip-ton, Newcastle-on-Tyne. [0516]

REPAIRS AND SERVICE

METROPOLITAN RADIO SERVICE.—Guaranteed repairs to American and British receivers; American valves, service parts and rewinds; trade supplied.—1021, Finchley Rd., N.W.1. Speedwell 3000. [0435]

REPAIRS to Moving Coil Speakers a Speciality; cones and coils fitted, fields altered; prices, including eliminators quoted; loud speakers, 4/; L.F. and output transformers, 4/-, post free, guaranteed satisfaction; trade invited, estimates free; prompt service.—Loud-Speaker Repair Works, 5, Balham Grove, London. Battersea 1321. [0394]

SITUATIONS VACANT

WIRELESS Technicians.

FOR H.M. Forces.

SPECIAL Enlistment of Staff Sergeants.

VACANCIES Exist in the Armament Artificer (Wireless) Section of the Royal Army Ordnance Corps for Technicians to Undertake Testing and Overhaul of Military Wireless Apparatus.

APPLICANTS Must Have Sound Theoretical Knowledge of Wireless, and be able to carry out tests of a laboratory nature on wireless sets.

"ASSEMBLY Line" Testers and "Radio Service" Engineers Will Not be Accepted Unless They Can Produce Evidence of a High Standard of Theoretical Knowledge.

AGE.—Over 22 and under 30, except in special circumstances.

MAXIMUM Rates of Pay and Allowances.

SINGLE Men Living Out; £5/0/5.

MARRIED Men Who Have Attained 20 Years of Age and Who Fulfill the Conditions Governing the Issue of Family Allowance; £5/8/3.

MARRIED Men With 1 Child; £5/13/3.

MARRIED Men With 2 Children; £5/16/3.

WHERE Public Quarters are Allotted, the rates for married men will be reduced by 19/6 per week.

CANDIDATES May Live Out During the Course.

UNIFORM and Kit Issued Free on Enlistment.

PROMOTION for Qualified Men, and, subject, to satisfactory conduct, increases in pay after 8 and 13 years' service.

PENSION.

PENSION From 32/- Per Week After 21 years' Colour Service, according to ranks held.

SELECTED Applicants Must be Medically Fit, and pass a test in Radio Technology and the practical use of modern testing equipment. These tests are carried out at Woolwich and last about three days, the journey and stay being made at the applicant's own expense.

APPLICATIONS Should be Made by Letter Marked "A.A. Wireless," to the Commandant, Military College of Science, Woolwich, S.E.18, giving details as follows:—

1. Firms worked for, period and actual work undertaken.
2. General education, Technical education, subjects, periods and certificates.
3. Date of birth, if married, number of children.

[8748]

AIR MINISTRY.

AERONAUTICAL INSPECTION DIRECTORATE.

VACANCIES Exist for Unestablished Appointments as Examiners in the W/T and Instrument Branches.

QUALIFICATIONS.

APPLICANTS for Vacancies in Instrument Branch Must Have Good General Education, theoretical knowledge of physics and training in light engineering or instrument making. Candidates should be able to read drawings, understand specifications and use micrometers and other types of measuring instruments. If necessary, preference will be given to candidates having a good knowledge of thermometry and optical and pressure measuring instruments.

APPLICANTS for Vacancies in W/T Branch Having the Following Qualifications will Receive Preference: good general education, sound technical knowledge of high frequency engineering equal to City and Guilds final examination in Radio Communications, practical knowledge of modern W/T and electrical equipment. Candidates should be able to read drawings, understand specifications and use micrometers and other measuring instruments.

APPLICATIONS from Candidates Previously Declared Unsuccessful will be Considered, provided the necessary additional experience has been gained.

SUCCESSFUL Candidates will be Given a Period of Training in Inspection as Applied to These Subjects, not exceeding three months.

DURING Training Candidates will be Regarded as on Probation and Paid at the Rate of £5/10 Weekly. On Satisfactory completion of the training course they will be appointed as Examiner and paid at £246 a year, rising by increments of £12 if service is satisfactory to £357, except that the starting salary for entrants below the age of 24 years will be reduced by £12 for each year below that age, payable monthly in arrears.

(This advertisement continued in third column.)

IMPORTANT NOTICE!

Just to remind YOU that **SOUND SALES LIMITED**, are Contractors to The Air Ministry, War Office, Admiralty, B.B.C., G.P.O. and L.C.C., etc., and specialise in the design and construction of Super Quality—

- (1). Amplifiers from 3 watts to 1 K.W.
- (2). Transformers of all types—single and three phase, from miniature L.F. types up to high voltage models for Neon Bombarding.
- (3). Chokes iron cored and air cored.
- (4). Last but by no means least—Special Radio Equipment from £20 to £200, designed especially to appeal to the Music Lover and Engineer.

May we send you our latest catalogue and technical manual . . . PRICE 6d.

Specified by  the Experts

SOUND SALES

MARLBOROUGH RD., UPPER HOLLOWAY, LONDON, N.19. (Contractors to the G.P.O., etc.)
Tel.: Archway 1661/2/3
Hours of Business—Monday to Friday, 8.30 a.m. to 6 p.m.
SATURDAYS CLOSED

For **PROMPT DELIVERY**
of **High Quality**

LOUDSPEAKERS, LOUD-SPEAKER CONES, LOUD-SPEAKER COMPONENTS, TRANSFORMER LAMINATIONS, TRANSFORMER HOUSINGS, TRANSFORMER WINDINGS, CHOKE WINDINGS, FIELD COIL WINDINGS, PERMANENT MAGNETS, PRESS TOOLS AND PRESSINGS, JIG BORING, AUTOMATIC SCREW MACHINE PARTS UP TO 2" DIAMETER.

Contractors to the Admiralty, War Office and Air Ministry.

Call on
BRITISH ROLA LTD.
MINERVA ROAD, PARK ROYAL, N.W.10.
PHONE: WILLESDEN 4522-3-4-5-6

THE INSTITUTE OF WIRELESS TECHNOLOGY
(Founded in 1925. Incorporated).

PROFESSIONAL MEMBERSHIP

The advantages of professional membership are open to all qualified wireless engineers.

Full information, with syllabus, may be obtained from the Secretary, Institute of Wireless Technology, 4, Vernon Place, Southampton Row, London, W.C.1. Phone: Holborn 4879.

SITUATIONS VACANT

(This advertisement continued from first column.)

SUBSISTENCE Allowance at the Rate of £1/5 Weekly is Payable Whilst Under Training to Married Men (and others with certain dependants) who normally reside outside the training centre.

CANDIDATES Must be Prepared to Serve in Any Part of the United Kingdom, and be willing to fly as observers in connection with their duties.

NORMAL Age Limits 21-50 Years. Candidates between 50-55 years will be considered if they have had previous inspection experience.

CANDIDATES Who on Interview Fail to Qualify for the Examiner Grade may be Considered for:—

ASSISTANT Examiner. Salary Scale £184-£10-£246.

ASSISTANT Examiners do Not Undergo Training, but are appointed direct to an A.I.D. station. They may later become eligible for promotion to Examiner on attaining the requisite standard of efficiency, provided they are willing to undertake the obligations required of examiners as above.

APPLICATION Must be Made on Form 786, copies of which can be obtained on application (by postcard only) to: The Under-Secretary of State, Air Ministry (I.C.S./Rec. 42), Berkeley Square House, Berkeley Sq., W.1. [8749]

TECHNICIAN for Component Test Bench and Assist Research Department.—Box 654, c/o The Wireless World. [8770]

JUNIOR Research Engineers for Radio Instrument Development Work.—Murphy Radio, Ltd., Welwyn Garden City, Herts. [8761]

DRAUGHTSMEN Required (in the Midlands), used to small part mechanisms; write, giving particulars of experience, also state age and salary required.—Box 647, c/o The Wireless World. [8763]

RADIO Testers and Inspectors, experienced with receivers and/or transmitters and associated equipment; top rates of pay to experienced men.—Write, stating age and experience, to Box 648, c/o The Wireless World. [8762]

IMPERIAL AIRWAYS Have Vacancies for Expert Radio Servicing Mechanics (non-flying), knowledge of aircraft installation an advantage but not absolutely essential.—Letters of application, stating age, experience and salary required, should be addressed to the General Establishment Officer, Imperial Airways, Airways House, London, S.W.1. Please mark the envelope GEO/9. [8765]

SITUATIONS WANTED

EXPERIENCED Radio Television Service Installation Engineer, own vehicle fully equipped, London and Northern suburbs.—Box 655, c/o The Wireless World. [8771]

WIRELESS Engineer, experienced construction, installation, radiotelephony, transmitters and marine direction finders.—Box 644, c/o The Wireless World. [8764]

RADIO Engineer, well-known expert. Czech, with thorough knowledge of both European and U.S.A. designing and production methods, also skilled in transmitters, in August visits England; seeks an English employer.—Box 645, c/o The Wireless World. [8760]

ELECTRIC DRY SHAVERS

REMINGTON, Rand, Shavemaster, Packard, Casco, Rabaldo.—Trade enquiries to Leonard Heys, 36, Henry St., Blackpool. [0633]

MISCELLANEOUS

RETAIL CREDIT FINANCE CORPORATION, Ltd., 123, Clapham Park Rd., S.W.4. Tele.: Mac. 2863. Established 1929. Accountants to the Trade, Company liquidations, Deeds of Arrangement, Status Enquiries, Repossessions, accounts collections. [8766]

EVERY Radio Dealer Who is Not a Regular Reader of "The Wireless and Electrical Trader" should send his trade card at once for a specimen copy and full details of the "Trader" Services. "The Wireless and Electrical Trader" has the widest influence, the largest weekly circulation, and is read by all the leading manufacturers and traders. Trade only. 15/- per annum, post free.—Published at Dorset House, Stamford St., London, S.E.1. [0615]

PATENT AND TRADE MARK AGENTS

GEE and Co. (H. T. P. Gee, Mem. R.S.G.B., etc.), 51-52, Chancery Lane, London, W.C.2. Holborn 4547-8. Handbook free. [0001]

TUITION

RADIO Training.—P.M.G. exams and I.E.E. Diploma; prospectus free.—Technical College, Hull. [0611]

MORSE Code Easily Learnt by Gramophone Records, all speeds, 2 to 20 words per minute; also private tuition; particulars, stamp.—Masters, Lincoln House, Copthorne Bank, Crawley, Sussex. [8683]

WIRELESS.—Complete training Marine, broadcast and television; posts waiting; mod. fees; boarders taken; approved college, prosp.—Dept. W., London Radio College, Grove Park Rd., London, W.4. (Chi. 3244.) [0580]

WIRELESS Careers; increased salaries and pensions make radio a profitable and interesting profession; we train students for all branches and guarantee appointments; Britain's leading Colleges; boarders accepted; write for free prospectus.—Wireless College, Colwyn Bay, or Wireless College, Calmore, Southampton. [8373]

We do quite a lot of business making up transformers to customers own specifications; but we have a standard list. May we send you a copy?



W. BRYAN SAVAGE LTD
Westmoreland Rd., London, N.W.9. Phone: Colindale 7131

Pamphonic AMPLIFIERS

Pamphonic Reproducers Ltd. (Associated with P.V. Ltd.)
45, St. Pancras Way, London, N.W.1.
Phone: EUSION 1727.

THE WIRELESS ENGINEER

The Journal of Radio Research and Progress

For professional wireless engineers, educational authorities, students, and all associated intimately with wireless.

Monthly 2s. 6d. net.
LIFFE & SONS LTD., LONDON, S.E.1

INDEX TO ADVERTISEMENTS

Anglo-American Radio (& Motors), Ltd.	PAGE 2
Armstrong Manufacturing Co.	2
Automatic Coil Winder Co., Ltd.	2
Barras, E. P., Ltd.	5
Belling & Lee, Ltd.	5
Birmingham Radiomart G5N1	5
British Institute of Engineering Technology	4
British Insulated Cables, Ltd.	4
British Mechanical Productions, Ltd.	4
British Rola	4
Capstan Cigarettes	5
Chloride Electrical Storage Co., Ltd.	5
Edison Swan Electric Co., Ltd.	5
Electradix Radios	5
Evrizone Radio & Television Co., Ltd.	5
Fluxite, Ltd.	1
General Electric Co., Ltd.	1
Goodmans Industries, Ltd.	1
Grampton Reproducers	1
Healey & Baker	4
Henley, W. T., Telegraph Works Co., Ltd.	4
Institute of Wireless Technology	4
International Correspondence Schools	4
Jackson Bros. (London), Ltd.	5
Lockwood & Co.	5
London Radio Supply Co.	5
Marconi-Ekco Instruments, Ltd.	3
Masters, C. E.	3
McClure, John, Ltd.	3
Pamphonic Reproducers, Ltd.	5
Partridge, N.	5
Periodical Trades Press	Inside Back Cover
Player's Cigarettes	3
Premier Supply Stores	3
Quartz Crystal Co.	2
Rothermel, R. A., and Co., Ltd.	2
Salford Electrical Instruments, Ltd.	Inside Front Cover
Savage, W. Bryan, Ltd.	5
Sound Sales, Ltd.	4
Stratton and Co., Ltd.	4
Summers, John, & Sons, Ltd.	5
United Insulator Co., Ltd.	5
Universal Electric	5
Varley, Ltd.	5
Voigt Patents, Ltd.	5
Vortexion, Ltd.	5
Webb's Radio	5
Webburn Radio, Ltd.	5
World Radio	1

BUSINESSES AND PROPERTY FOR SALE, TO BE LET, OR WANTED

WIRELESS and Electrical Business, N.W.10 district, for sale, long lease, low rent, new shop front, £250; stock at valuation or near offer.—Box 658, c/o *The Wireless World*. [8775]

THE Wireless and Electrical Trader is an essential part of the equipment of every Wireless Trader; its pages reflect the very latest turn of trade events, and it is read by all the leading dealers and manufacturers, for particulars of businesses offered or wanted. By subscription to the trade only, 15/- per annum, post free.—Send your trade card for specimen copy to Dorset House, Stamford St., London, S.E.1. [0614]

BOOKS, INSTRUCTION, ETC.

AMERICAN Valve Data.—The 200-page Raytheon Data Book gives full characteristics, applications, all types American valves; invaluable to servicemen; post free anywhere; 2/3.—Leonard Heys, 35, Henry St., Blackpool. [0594]

ALL Wireless and Radio Engineering Books Available through new financial terms as low as 2/6 monthly.—Write a card or call personally for details and lists from the Radio Department, Phoenix, Chandos Place, W.C.2. [8623]

FOUNDATIONS of Wireless." By A. L. M. Sowerby, M.Sc. Second edition. An elementary textbook on receivers. Deals fully with the construction of wireless sets, valves, and the process of detection. Price 4/6 net. By post 4/11, from Iliffe and Sons Ltd., Dorset House, Stamford Street, London, S.E.1.

RADIO Data Charts." By R. T. Beatty, M.A., B.E., D.Sc. Second edition. A series of Abacs providing most of the essential data required in receiver design and enabling problems to be solved without having recourse to complicated mathematical formulae. Price 4/6 net. By post 4/10, from Iliffe and Sons Ltd., Dorset House, Stamford Street, London, S.E.1.

ELEMENTARY Principles of Wireless Telegraphy and Telephony." By R. D. Banguay, Revised by O. F. Brown, B.Sc. Third edition (1930). The standard textbook for wireless students and beginners. Deals with the whole subject of wireless telegraphy and telephony, avoiding too technical a treatment of the problems involved. Well illustrated. Price 7/6 net. By post 8/-, from Iliffe and Sons Ltd., Dorset House, Stamford St., London, S.E.1.

THE Wireless World" Diary for 1939 contains 77 pages of facts, formulae and general information of the kind that is always wanted but is difficult to follow. Also a list of the most important European Broadcasting Stations and short-wave stations of the world. Twelve pages of circuit diagrams of receivers, amplifiers and units.—By post 1/7 from Iliffe and Sons Ltd., Dorset House Stamford Street, London, S.E.1.

Fourth Edition—

WIRELESS SERVICING MANUAL

By **W. T. COCKING**
(of "The Wireless World")

The most complete book of reference of its kind. A reliable practical guide for amateur and professional.

The "Wireless Servicing Manual" deals fully with Testing Apparatus, and explains the methods of locating and curing faults in receiving equipment. Includes a special chapter on Television Receivers.

Ganging, Automatic Volume Control, Instability, Distortion, Mains Hum, Whistles and Local interference, are all separately treated. There is also a special chapter on the Aerial-Earth System.

Information on short-wave receivers, and on methods of operating extension loud speakers, has been added. The reference material, including base-connections for British, Continental and American valves, and the various colour codes for components, has been extended and brought up to date.

5/- net By post 5/5

Issued in conjunction with "THE WIRELESS WORLD" and Published by the Proprietors:—
LIFFE & SONS LTD.,
DORSET HOUSE, STAMFORD ST., LONDON, S.E.1

ELECTRADIX BARGAINS
Summer Redecoration Sale !!!

A.R.P. TRANSMITTERS. Aircraft 2-valve, old type, R.A.F., with valves, 17/6. Field Transmitters, ex-Army type, 1 and 2 valve, portable, totally enclosed with Valves, folding key and aerial meter, 40/-. Sullivan variable R.F. inductances, 7/6. A.C. Hand Generators, 7 P.T., geared drive, 80 volts, 20 m.a., 5/- 2 valve Receivers to match with Valves, 40/-.
DIAL TUNING. 10-point Finger Switch Dials, as illus., used on G.P.O. Automatic Telephones. These have spring drive, governor, clutch and contacts inside. Price 2/6.

BUZZERS. Buzzers for Signals, Wave-meters or Testing. High Note Model T, smallest Buzzer possible, very sensitive. Platinum contacts. List, 10/-. Sale, 6/-. High Note "D.M." Buzzer in case, 3/6. Service Buzzer No. 24, 12/6. D.I.II Double Circuit-Twin Buzzers, 10/-. 20 volt G.P.O. Buzzers, 3/6. Small Buzzer, 1/6. Larger models, 2/6 and 3/-.
G.P.O. 42 MORSE SOUNDER BUZZERS. On Mahogany base, 7/6. Telegraph Vertical Needle Signal Buzzers, 4/-.
MORSE PRACTICE SETS. No. 3, with key, buzzer and lamp for sound and visual line plug, etc., 7/-. Sound Type, 1A type key and buzzer, 3/-. Visual Type 2A, key and lamp, 2/-.
KEYS. Govt. surplus table Morse Keys. Type KBSL. Polished wood base, massive brass pivot bar, tungsten spring-mounted contacts for quiet working and base lamp for light. A first-class key for operators, 7/6.
100 ELECTRIC DRILL STANDS. Massive W.G. Geared rise and fall with counterweight. Suitable large or small machines, 7/6, carr. fwd.

HEADPHONES. Lightweight for crystals. Famous, makes. 2,000 ohms, 4/6. Single high res. earpieces, 2/6. Sullivan 120-ohm W.D. model. Aluminium body and head-bands. Maker's price to-day, 15/-. Our price, 2/9 per pair. 3d. postage.

CRYSTAL SETS. Model B, pol. mahog. case, 9in. x 16in. 2 tuning condensers, plug-in coils, Permanent Detector, 7/6. 4,000 ohms. Phones, 4/6.
MIDGET 49 CRYSTAL SET, complete with Perm. Detector, 6/9. M 111 Army Double Crystal All-wave Receiver, very rare. Cost £20. 56/-.
M 111 Station Finder W.D. Crystal Set, double Detector, wave range calibrated in enclosed mahog. case, 24/6.

CRYSTALS, RECEIVING. Super Detector, glass cover, fine adjustment, 10/-. Enclosed 2-crystal Permanent Detector, 2/-. Carborundum Marconi Army Detector, 2/6. Galena Point Detector, mounted, 1/6. Galena and Neutron Crystals, 4d., 6d., and Perikon, 1/-. Carborundum mounted, 8d.

CRYSTAL OR BATTERY SET BUILDERS. Fitted Table Cabinet, polished oak, 13 1/2in. x 7in. x 6 1/2in., oval aluminium black panel fitted geared .006-mfd. sunk dial, 3-way coil switch and a single plate vernier condenser, and 19 terminal Strip, new stock, 15/-.
METERS, Weston model 354. Central zero 1 to 15 amps, pol. mag. Flush panel, 2 1/2in. dial. Sale price, 7/6. 0-20 volts, 5/9. 50 volts, 5/9. 0-100 volts, 5/9. for A.C. or D.C. Hoyt 1/2 mov. coil milliammeters, 25-0-25 m.a., 10/-. Weston 0 to 30 m.a., mov. coil milliammeters, 17/6. 0-100 m.a., 17/6. 200 m.a., 17/6. Switchboard Meters, all sizes, cheap.
TEST METERS. For fault finding, etc. Bargain line in portable moving-coil by Everett Edgcombe, 40 to 120 volts for home conversion to multi-range, 10/6. 1,000 volts, 22/6.
M.C. METER MOVEMENTS for making multirange meters. Low m/a. 2 1/2in. dial, 6/- each; higher 6in. dial, 5/- each. Post 1/-.
FREQUENCY METERS. 4 1/2in. dial, 100 cycles, 30/-. 500 cycles, 40/-. 50 cycle mains, 50/-.
MEGERS, as new. Direct Reading, .001 ohms to 10 megs. Long scale dial for Resistance makers, 100, 250 and 500 volts, cheap. SILVERTOWN Portable Tester. Combines Wheatstone Bridge, Galvo, shunts and ratios, as new, £8. G.P.O. Plug-in Bridges, several as new, cheap.

THE FEIGH RECORDER. Still a Few Left. Positive drive, worm gear and rack. Complete for use, only 37/6. Super Feigh Fidelity Set, 42/6. Tracking Gear only 21/-. Either 3/8 oz. metal blanks can be used, or the glass-coated simples, 10in., 3/- each. Pre-amplifiers for Recording Tables, 1-valve Battery Model in cabinet, 25/-. A.C. Mains pre-amplifiers, with SPECIAL CLEARANCE. Valve rectifier, steel-cased model, 60/-. Parcels of experimental additons, coils, magnets, wire choices, condensers, mikes, switches, terminals, etc. Post free, 10lb., 5/-. Very useful Bargain.

Sale List "W" Free on request.
ELECTRADIX RADIOS
218, UPPER THAMES STREET, LONDON, E.C.4
Telephone: Central 4611

TO SERVICE MEN

Bargain Offer!!!
A SERVICE KIT FOR 17/6

This Service Kit comprises:
4 VOLUME CONTROLS. 20,000, 50,000, 1 meg., 1/2 meg.
72 RESISTORS. Assorted, colour coded resistors. 1/2 to 3 watts
2 DOZ. CONDENSERS. Assorted tubular electrolytic and mica condensers.
1 STEEL CABINET. A very useful steel cabinet with partitions for above, screws, etc.

VALUE £4 for 17/6
KIT No. 1 comprising resistors and condensers only as above, 12/6.
KIT No. 3 comprising volume controls and cabinet only 6/3.

SPECIAL OFFER!!!
Fully shrouded Transformers by America's largest manufacturer. While they last.
All 250 v. primary and fully impregnated.
T28708—375/375 v. 150 m/A., 6.3V5A, 2.5V5A, 5V3A..... 15/-
T19610—350/350 v. 150 m/A., 2.5V6A, 2.5V2A, 3V3A..... 12/6
T7236—375/375 v. 120 m/A., 6.3VCT. 4A, 5V3A..... 10/6
T7326—350/350 v. 100 m/A., 6.3VCT. 3A, 5V3A..... 8/6
T7307—350/350 v. 80 m/A., 6.3VCT. 3A, 5V3A..... 7/6
T7006—320/320 v. 80 m/A., 6.3V4A, 5V3A..... 7/6
T6025—320/320 v. 80 m/A., 2.5V6A, 5V3A..... 7/6
T464919—10V4A Primary Tapped 110-250 v..... 5/6
T113AB—110/230 v. 500 watt Auto Transformer..... 29/6

The following choices are interrelated and impregnated.
T7007—250 m/A., 155 ohms, 29-3 Hy., cadmium shrouded..... 12/6
T7007A—150 m/A., 250 ohms, 30-12 Hy., cadmium shrouded..... 12/6
100 m/A., 20 Hy., 500 ohms, unshrouded..... 4/11
60m/A., 15 Hy., 250 ohms..... 1/11

RADIOMART Telephone: MIDLAND 3254.
G5N1 (Birmingham) Ltd.
44, HOLLOWAY HEAD, BIRMINGHAM

Sixth EditionRevised and Enlarged

HANDBOOK of TECHNICAL INSTRUCTION for WIRELESS TELEGRAPHERS

by H. M. DOWSETT

(M.I.E.E., F.Inst.P., M.Inst.R.E.)

This standard handbook is planned primarily for the use of wireless operators, whether prospective or actual. It is virtually a complete theoretical course for students wishing to qualify for the Postmaster-General's Certificate of Proficiency.

CONTENTS INCLUDE :

The Electric Charge and the Condenser—The Condenser in Practice—Direct Current and Ohm's Law—Scalar and Vector Quantities and Curve Plotting—Primary Batteries—Accumulators—Magnetism—Electro Magnetism—Self-Induction—Dynamo Electric Machines—Measuring Instruments—Switchboards and Switchgear—Alternating Current Effects, and Vector Diagrams—Alternating Current Fundamental Formulae—Alternating Current Generators, Alternating Current Motors and Transformers—Damped Oscillations—Commercial Types of Spark Transmitter—Aerials and Radiation—Simple Receiver Circuit and Crystal Detector—Thermionics and the Various Applications of the Valve—Depth Sounding—Valve Transmitters—Wavemeter and Transmitter Adjustment—Theory of Valve Receiver Circuits—Valve Receivers—Short Wave Aerials and Apparatus—Marine Direction Finders—Marine Audio Relay Service—Distress Call Apparatus—Lifeboat and Emergency Outfits—Trawler Apparatus—Maintenance of Marine Radio Installations and Possible Faults.

PRICE 21/- By post 21/9

By Foreign Post 22/-

Obtainable from leading booksellers or direct from the Publishers :

ILIFFE & SONS LTD., DORSET HOUSE, STAMFORD STREET, LONDON, S.E.1

The ELECTRICAL REVIEW

The Complete Technical Journal

Practical articles on all aspects of electricity supply and utilisation—industrial, commercial and domestic. Latest news of the electrical industry and developments. Advertisement pages form a comprehensive buyers' guide.

Contents of August 4th Issue

HOLIDAY CAMPS

An account of the extensive use of electricity for lighting, cooking, pumping, etc., at large camps on the East Coast.

RESEARCH AND RESULTS

A number of outstanding modern developments (sound films, plastic mouldings, etc.) are discussed from the research scientist's point of view.

BRITISH STANDARDS INSTITUTION

The history and activities of this important body from the pen of its Director.

EGYPTIAN ELECTRICAL MARKET

The position of British manufacturers in the electrical and radio market is dealt with, and possible developments are forecast.

ELECTRICAL NEWS OF THE WEEK

EVERY FRIDAY 6d.

Subscriptions: United Kingdom £1 14 8.
Canada £1 12 6. Other Countries
£2 1 6 per annum, post free.

ELECTRICAL REVIEW LTD.

Dorset House, Stamford Street, London, S. E. 1

RADIO LABORATORY HANDBOOK

By M. G. SCROGGIE, B.Sc., A.M.I.E.E.

Issued in conjunction with "The Wireless World"

384 pp.
211
illustrations

PRICE
8/6 net

By post 9/-

"Radio Laboratory Handbook" is the only practical and reliable handbook on the subject. It gives the serious wireless worker complete information from first-hand experience about laboratory equipment, the instruments which are necessary and the correct methods of operating them.

The fundamental principles are fully discussed, as well as the sources of power and signals, instruments and measurements. Other sections deal with ultra-high-frequency work, the working out of results, and reference data. There is also a collection of the most useful symbols, abbreviations, formulæ, laws, curves, tables and other data.

A complete index, numbered sections and cross references enable the reader to find what is required without loss of time.

From Bookstalls and Booksellers or direct from the Publishers

ILIFFE & SONS LTD., DORSET HOUSE, STAMFORD STREET LONDON, S.E.1

1 TRADE
DEVELOPMENT
AND
PROGRESS

2 FACTS OF
PRODUCTION
AND
DISTRIBUTION

TRADE & TECHNICAL JOURNALS

3 INFLUENTIAL AND
AUTHORITATIVE

4 BUYERS
REFERENCE

If you are seeking new markets, or desire to get first-hand information about a trade or industry, you cannot go to a more reliable or authoritative source than the trade and technical journals serving it. The address of any paper in this list will be furnished on request.

Architect and Building News.
Architects' Journal.
Architectural Review.
Autocar.
Automobile Engineer.
Baths and Bath Engineering.
Bicycling News.
Boxmakers' Journal and Packaging Review.
Brewers' Journal.
British Baker.
British Engineers' Export Journal.
British Journal of Photography.
Bus and Coach.
Caterer and Hotel Keeper.
Chemist and Druggist.
Cigar and Tobacco World.
Colliery Guardian.
Confectionery Journal.
Confectionery News and Ice Cream and Soda Fountain Journal.
Contractors' Record and Municipal Engineering.
Dairyman.
Drapers' Organiser.
Drapers' Record.
Dyer.
Electrical Engineer.
Electrical Review.
Electrical Times.
Electrical Trading and Electricity.
Engineer.
Engineering.
Export Trader.
Footwear Organiser.

Furnishing Trades' Organiser.
Grocer and Oil Trade Review.
Grocers' Gazette and Provision Trades' News.
Grocery and Branch Store Management.
Hairdresser and Beauty Trade.
Hotel and Catering Management.
Hotel Review.
India-Rubber Journal.
Ironmonger.
Journal of Decorative Art.
Kinematograph Weekly.
Laundry Journal.
Laundry (The Power).
Laundry Record.
Licensing World.
Locomotive, Railway Carriage and Wagon Review.
Machinery.
Meat Trades' Journal.
Mechanical World and Engineering Record.
Men's Wear.
Metallurgia.
Mining Journal, Railway and Commercial Gazette.
Model Engineer and Practical Electrician.
Modern Transport.
Motor Cycle.
Motor Cycle and Cycle Trader.
Motor News.
Motor Trader.
Motor Transport.

Motor World and Industrial Vehicle Review.
Motorist.
Nursing Mirror.
Oil and Colour Trades Journal.
Optician.
Overseas Engineer.
Photographic Dealer.
Plumbing Trade Journal.
Pottery Gazette and Glass Trade Review.
Poultry.
Printers', etc., Sales and Wants Advertiser.
Retail Chemist.
School and College Management.
Silk Journal and Rayon World.
Small Trader.
Smallwares, Novelties and Dress Accessories.
Specification.
Statist.
Style for Men.
Textile Manufacturer.
Textile Recorder.
Tobacconist and Confectioner.
Tourist.
Waste Trade World.
Watchmaker and Jeweller, Silver-smith and Optician.
Water and Water Engineering.
Wine and Spirit Trade Review.
Wireless and Electrical Trader.
Wireless Engineer.
Wireless Retailer and Broadcaster.
Wireless World.

Official Handbook, giving particulars of over 500 papers, post free 1/-.

PERIODICAL, TRADE PRESS AND WEEKLY NEWSPAPER PROPRIETORS' ASSOCIATION, LTD.

Telephone:
Central 2441.

6, Bouverie Street, London, E.C.4

Telegrams:
Weneppa, Fleet, London.

Mention of "The Wireless World," when writing to advertisers, will ensure prompt attention.

DAILY SKETCH

FOR
INSIDE INFORMATION
ON



FOREIGN AFFAIRS

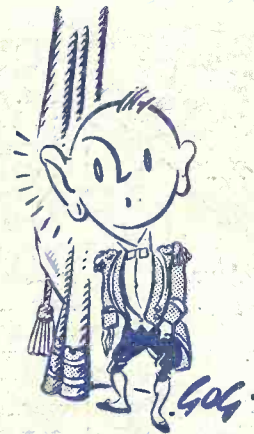

SOCIETY



THE TURF

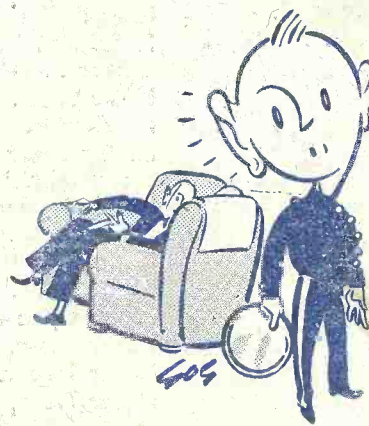

CLUB LIFE

THE DAILY SKETCH IS EASILY FIRST

6^D

The
Wireless
THE PRACTICAL
World
RADIO & TELEVISION JOURNAL

Thursday, September 7th, 1939

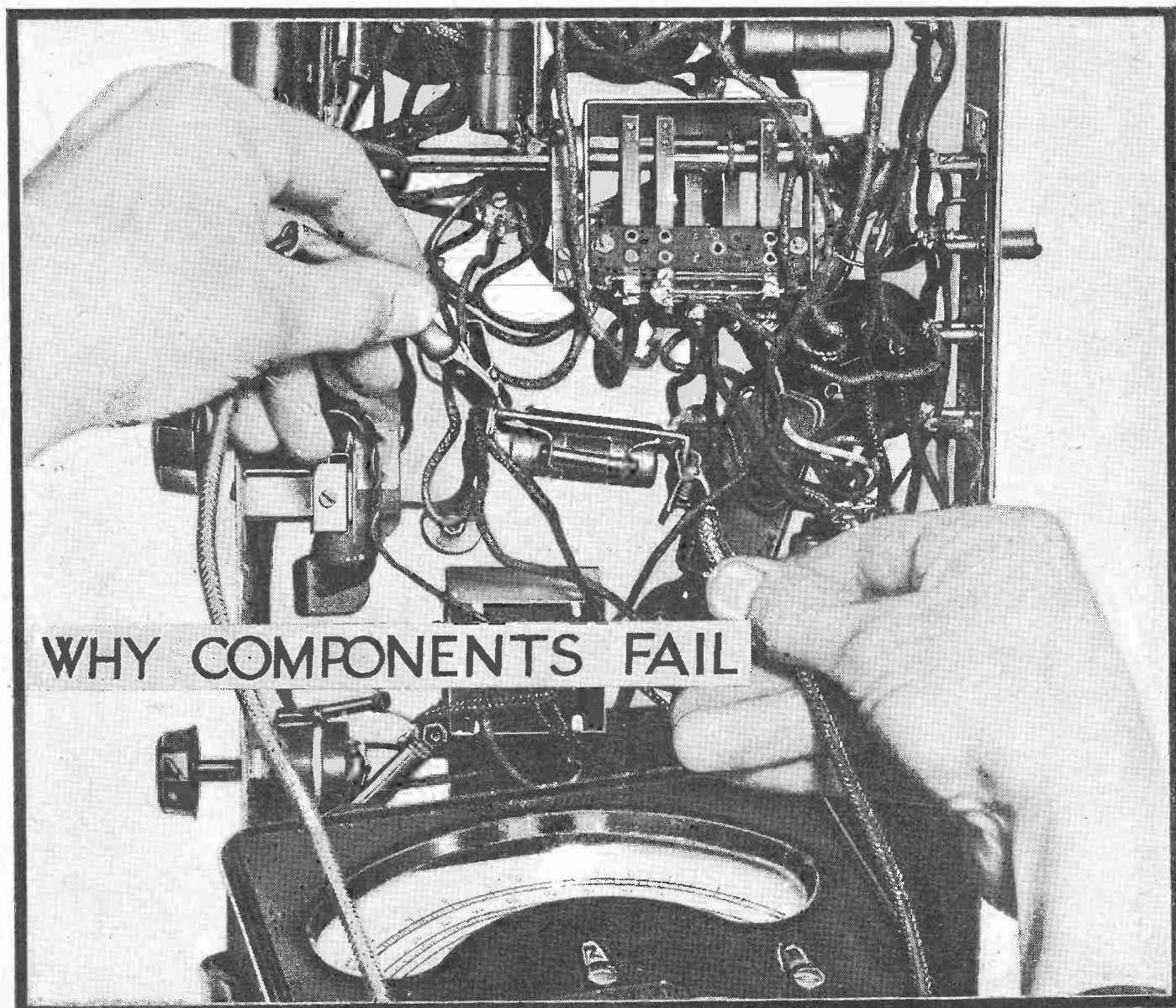

WHY COMPONENTS FAIL



'AVO' Precision
ELECTRICAL
TESTING
INSTRUMENTS

Red Trade Mark

The Universal AVO MINOR
Electrical Measuring Instrument.

This compact precision moving-coil instrument covers all A.C. and D.C. testing. It has 22 ranges for measuring A.C. voltage, D.C. voltage, current and resistance. All readings are direct. No calculations. The high total resistance of the instrument—200,000 ohms—ensures accurate readings. Complete with instruction booklet, leads, interchangeable testing prods, £5. 10s. and crocodile clips.

Leather Carrying Case, 10/-

BRITISH
MADE

16 Gns.

Model 7 Resistance Range Extension Unit (for measurements down to 1/100th ohm) 12/6

Also, the 40-range Universal AvoMeter 14 Gns.

The 22-range D.C. AvoMeter 9 Gns.

Leather Carrying Case - - 25/-



The MODEL 7
46 Range Universal **AVO METER**
Electrical Measuring Instrument.

A compact multi-range A.C./D.C. meter, it has 46 ranges covering A.C. and D.C. amperes and volts, also resistance, capacity, audio-frequency power output, and decibels. No external shunts or series resistances required. The meter conforms with B.S. first grade accuracy requirements; has a 5in. mirror scale; is provided with automatic compensation for errors arising from variations in temperature; and is protected by an automatic cut-out against damage through overload.

All "AVO" Instruments are available on Deferred Terms.

SIX RANGES

0-.0005 Mfds.	.003-.005 Mfds.
.0005-.0015 Mfds.	.005-.01 Mfds.
.0015-.003 Mfds.	.01-0.1 Mfds.

The "AVO" CAPACITY METER

A simple and accurate capacity meter, reading capacities directly from a calibrated dial. Six ranges; measurements can be made from a few mmfd. to 0.1 mfd. (100,000 mmfd.) correct to within an error of less than 1%. Measurements carried out by a resonance method, the unknown condenser being introduced into a tuned circuit coupled to a radio frequency oscillator. A meter gives visual indication of resonance; length of meter deflection gives a comparative measure of losses of condenser under test. **£23**

* Write for fully descriptive Leaflets.

Sole Proprietors and Manufacturers:—
THE AUTOMATIC COIL WINDER & ELECTRICAL EQUIPMENT CO., LTD.
Winder House, Douglas Street, London, S.W.1.
Phone: Victoria 3404-7.

WHEN DEPENDABILITY IN AN EMERGENCY IS A QUALITY THAT CANNOT BE OVER-RATED

— SPECIFY SOUND SALES

Sound Sales Amplifiers are recognised by all established experts to be second to none in compact design, engineering construction, performance and general utility. We have a special department detailed to concentrate on the survey and installation of A.R.P. Communication Systems under the direction of ex-service men who are able to appreciate the conditions and thus offer specialised technical advice. The illustration shows a typical Sound Sales self-contained Amplifier.

We shall be pleased to send you further details of this model together with a unique but inexpensive multi-channel system which can maintain communications under the most arduous conditions.

May we send you our latest Catalogue and Technical Manual - - - - - Price **6d.**



All SOUND SALES products can be obtained on DEFERRED TERMS from the LONDON RADIO SUPPLY COMPANY, 11, Oat Lane, Noble Street, E.C.2

SOUND SALES LTD.
MARLBOROUGH ROAD, UPPER HOLLOWAY, LONDON, N.19
Telephone: ARChway 1661-2-3.
CONTRACTORS TO THE AIR MINISTRY, G.P.O., ETC.

Mention of "The Wireless World," when writing to advertisers, will ensure prompt attention.

The Wireless World

THE PRACTICAL RADIO JOURNAL
29th Year of Publication

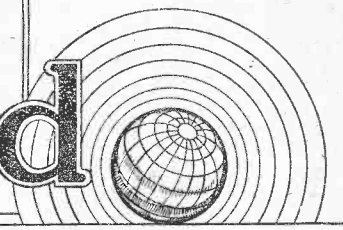
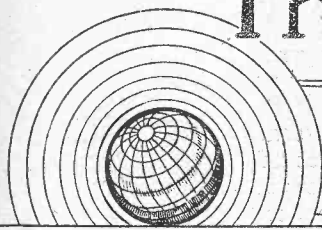

No. 1045

THURSDAY, SEPTEMBER 7TH, 1939

VOL. XLV No. 10

Proprietors : ILIFFE & SONS LTD.

Editor :
HUGH S. POCOCK.

Editorial,
Advertising and Publishing Offices :
DORSET HOUSE, STAMFORD STREET,
LONDON, S.E.1.

Telephone: Waterloo 3333 (50 lines).
Telegrams: "Ethaworld, Sedist, London."

COVENTRY: 8-10, Corporation Street.
Telegrams: "Autocar, Coventry." Telephone: 5210 Coventry.

BIRMINGHAM:
Guildhall Buildings, Navigation Street, 2.
Telegrams: "Autopress, Birmingham." Telephone: 2971 Midland (5 lines).

MANCHESTER: 260, Deansgate, 3.
Telegrams: "Iliffe, Manchester." Telephone: Blackfriars 4412 (4 lines).

GLASGOW: 26B, Renfield Street, C.2.
Telegrams: "Iliffe, Glasgow." Telephone: Central 4857.

PUBLISHED WEEKLY. ENTERED AS SECOND CLASS MATTER AT NEW YORK, N.Y.

Subscription Rates :

Home and Canada, £1 10s. 4d.; other countries, £1 12s. 6d. per annum.

As many of the circuits and apparatus described in these pages are covered by patents, readers are advised, before making use of them, to satisfy themselves that they would not be infringing patents.

CONTENTS

	Page
Editorial Comment	227
Why Components Fail	228
On the Short Waves	230
Problem Corner	230
Impressions of Olympia: "Dial-list" Looks Back at the Show ..	231
Cathode-Ray Photography	233
Mechanics of Receiver Design	235
Five-metre DX	237
American Progress—And Ours	238
Random radiations	240
News of the Week	241
Unbiased	242
Olympia Conventions: Technical Meetings at the Show	243
Voltage-dropping Resistances	245
Recent Inventions	246

EDITORIAL COMMENT

Wireless and War

Services to the Nation

THOSE of us who have spent our working lives in the service of wireless must often have taken encouragement from the thought that the part we have played, humble though it may be, has contributed something towards the good of humanity. The record of wireless is indeed nothing to be ashamed of: we think of the thousands of lives saved from the perils of the sea by wireless telegraphy and of the interest and widening of outlook brought to millions by broadcasting. But it has long been a cause for regret to many of us that the self-evident potentialities of broadcasting in the cause of peace have been exploited with such poor success.

"Nation shall speak peace unto nation" was an inspiring motto for those responsible for British broadcasting, and it was one which they conscientiously strove to justify. That it has so far failed to achieve results does not imply that any blame is to be apportioned, and, even if it were, this is no time for recriminations.

International Broadcasting

Although wireless may not have succeeded in this respect, it has performed a wonderful service to everyone during the dark days of suspense. Anxiety and uncertainty has been relieved, and the extraordinary calmness of the British nation must surely be due in no small measure to the thoroughness of the B.B.C.'s news service. Other organisations that deserve the thanks of the world are the great American broadcasting networks. Considering their position as neutrals and making allowance for the Transatlantic tendency towards dramatisation of news, the crisis

has been handled with admirable restraint. So far as broadcasts that we ourselves have heard or seen reported are concerned, nothing has been done to exacerbate the European situation; on the contrary, obviously genuine efforts have been made to play the part of peacemaker. The broadcasting of news bulletins from America in the languages of all potential belligerents has probably done good. Coming from a neutral country, such messages probably carry more weight than if they emanated from a more directly interested and inspired source.

We must not delude ourselves into thinking that the kind of international short-wave broadcast to which we have just referred reaches a very wide audience. The number of efficient short-wave sets in use is still small, though the better types are now more readily available than hitherto. We can foresee a wide market for them when more normal conditions return. As a contributor says elsewhere in this issue, there is nothing like a good wireless set for collecting news; it gives its owner the feeling of being in intimate touch with things as they happen, and he becomes something more than a mere spectator, remote and aloof from actualities.

Whatever the days ahead may have in store for us, there is one thing that we can face with the most serene confidence. The wireless service, though young in years, has already established a tradition of steadfast devotion to duty on the part of its personnel of which we are all justifiably proud. Maintenance at extreme efficiency of all forms of wireless communication is now vital to the successful prosecution of the war; the various branches of the service may meet with difficulties that none of us can yet foresee, but, whatever these difficulties may be, communication will be maintained.

Why Components Fail

RELATIVE SUSCEPTIBILITY TO BREAKDOWN

THERE is no substitute for the close inductive reasoning of which every serious radio man must be capable—especially if he has much to do with the tracing of faults in modern receivers. But out of experience comes an intuitive knowledge of where common troubles are likely to lie, and this enables the skilled man to short-circuit some of the laborious fundamental testing and go straight to the component that is the probable cause of the trouble. A knowledge of the primary causes of breakdown in generally used components is a useful aid to such speedy diagnosis.

Speaking very generally, it may be said that those components combining mechanical movement with electrical function are, on the whole, liable to develop unsatisfactory behaviour, if not complete failure, before the rest. It is probable, as a matter of fact, that such components only seem to develop faults before the rest because their physical movement reveals impending defects. In other components the process of deterioration is difficult to detect before the stage of complete failure is reached. Placing them roughly in order of liability to give trouble, then, volume controls of the high-resistance potentiometer type are notoriously liable to give rise to noises; switches seem to come next, then loud-speaker speech coils. In the class of fixed components, condensers seem to fail before resistors, and coils, including the windings of chokes and transformers, last of all. Valves are in a class by themselves. The nature of the defects to which these various components are liable will now be discussed.

In these days of AVC for preventing excessive amplification of signals in the RF stages, output level is usually controlled by high-resistance potentiometers connected across two points of AF difference of potential, such as the secondaries of transformers or the load circuits of diode detectors. In these positions they seldom handle much power and the causes of their failure lie more in the inherent shortcomings of their materials and construction than in the functions they have to perform.

Potentiometers usually consist of a thin layer of composition resistive element fixed to an insulating base, and the moving contact is made by a squash-plate. The expansion with heat of the element itself may not be the same as that of the base to which it is fixed, and the frequent and considerable temperature changes that occur in a mains-driven receiver cause the element to crack.

By W. H. CAZALY, Grad.I.W.T.

ment that is not normally used, either the extreme loud or low volume ends, and until the crack is complete it may pass unnoticed. Although the squash-plate is a far better method of making moving

A KNOWLEDGE of the liability to breakdown of the various components of a receiver often saves waste of time in searching for a fault; the present article discusses this matter and also describes the usual causes of failure.

contact than a rubbing slider (which is liable to break up the smooth, hard surface of the element) it does not entirely overcome a very common difficulty which is known as "hop-off resistance." As the contact passes from the end contact to the body of the element, a sudden change of resistance in that arm of the potentiometer from almost zero to, perhaps, many thousands of ohms, takes place, and the volume, instead of decreasing gradually, does so abruptly. Again, since contact at the ends of the element is often made by painting with colloidal

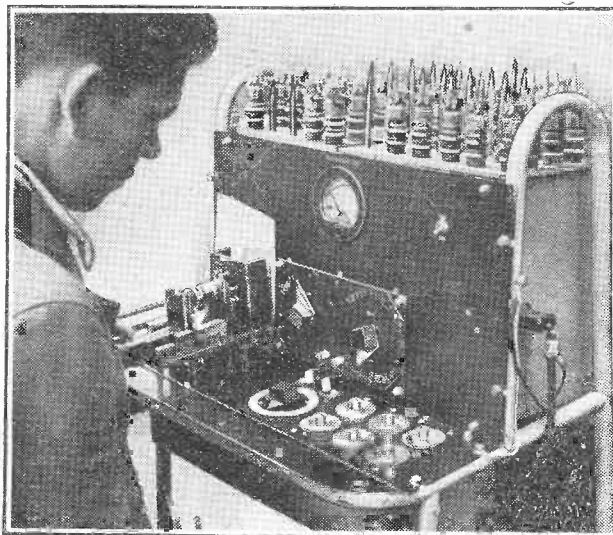

Gourtesy Pye, Ltd.

Prevention is better than cure: testing and matching of components is an important part of factory routine.

copper—finely divided copper or bronze particles suspended in liquid—this thin layer of copper paint may crack away

from the element, and when the squash plate impinges on this cracked contact the resultant noises are only too familiar.

Switches suffer from the effects of either dirt or oxidation. Rubbing contacts usually avoid these effects, but if the insulating material over which the rubbing contacts pass between the fixed contacts is soft, or itself likely to deteriorate with age through surface oxidation—ebonite is a frequent offender in this respect—it forms a layer on the rubbing contact. This can be removed with *very* fine abrasive paper. Pressure contacts in the better class switches are coated with some non-oxidising metal, and, as this is usually very thin, it should not be cleaned with abrasive; petrol, or even "penetrating oil," if afterwards removed, is best. The on-off switches in mains-driven receivers should, if of good quality, stand up to some 20,000 operations on full load of about 2 amps at 250 volts. Their failure is usually mechanical—the speed of opening the contacts falls and gives rise to arcing.

Speech Coil Defects

Considering the hard work they do, speech coils show a reliability that does credit to the immense amount of trial and research preceding their manufacture. Apart from obvious troubles due to incorrect centring and the like, they are liable to a loosening of the wire on the former, owing to the unequal expansion with heat of wire and former. This causes a shrill buzz, often only on certain frequencies, and the defect is usually not discernible when the coil is inspected cold. Coating the ends of the speech coil with cellulose or bake-lite cement is always a wise precaution if nothing else is obviously wrong.

Electrolytic condensers are essentially electro-chemical devices, and their behaviour can therefore be upset both during the forming process in manufacture and in subsequent use by minute chemical impurities in either the electrolyte or the metal of the electrodes, especially the positive element, which is usually aluminium. The action of chemical impurity is cumulative, so that even if a film of oxide formed during manufacture on the positive aluminium is sufficiently continuous and thick to enable the condenser to pass ordinary tests, in subsequent use further electrolytic action will take place due to the impurity and result in corrosion of

the electrode and the destruction of the oxide layer. Once a leakage path is set up by this process, heat generated at that

Why Components Fail—

spot by the passage of current makes matters worse.

An electrolytic condenser has a limited "shelf-life": if not used, the oxide film slowly dissolves, and if, on again putting the condenser into use, the full rated voltage is applied, so much current passes that heat is generated and the oxide layer cannot re-form. Hence, a long disused electrolytic condenser should be gradually reformed by the application of low initial voltage which can be steadily increased until the rated value is reached. Loss of capacity is due either to drying up of the electrolyte or to the oxidation of the aluminium where it is attached to the external lead—at which point soldering is almost impossible. Loss of capacity also occurs as a natural result of the passage of the small leakage current that is inevitable with electrolytic condensers: this current tends to exhaust the active chemicals of the electrolyte by continued electrolysis, or even to build up the oxide layer faster than it is dissolved by the electrolyte, making it a thicker dielectric.

Superimposed on the steady DC voltage, at which the condenser is designed to operate, there is very often an AC component—such as the ripple that electrolytic condensers are required to eliminate in smoothing circuits. This ripple voltage drives a current through the condenser which may be concentrated at spots where the oxide film is thinner and so give rise to localised heat. For this reason the breakdown of some component in another part of the circuit which tends to increase the ripple voltage—for example, a partial short-circuit of the HT supply so that excessive current passes through the smoothing choke, reducing its inductance—may cause an electrolytic condenser to break down. Although normally the temperatures reached in a mains driven receiver keeps the atmosphere round the electrolytic condensers dry, cases may arise in which the condenser can absorb moisture, which may cause internal sparking, with consequent charring of the impregnated cotton spacing between the electrodes.

Paper—dielectric Condensers

The larger solid dielectric condensers usually have aluminium foil plates, and the impossibility of attaching these to external leads by soldering gives rise to poor contact at these points and apparent loss of capacity. Short-circuits in such condensers, without the application of excessive voltage or the passage of AC, seem usually to be due to impurities in the paper or the wax used as the dielectric; leakage currents initiated by such defects give rise to localised heat and charring of the wax and paper.

Fixed resistors deserve a book to them-

selves. They are, as a matter of fact, a makeshift forced on us by the failure of Nature to provide us with a good choice of substances having specific resistance between that of the fairly good conductors and that of the insulators. Those that have such intermediate resistivity, such as germanium, are either rare and expensive or chemically and physically unsuitable. Moreover, it seems to be impossible to predict from its chemical or physical structure what the electrical behaviour of any compound is going to be, and knowledge in this direction is largely empirical. Hence, in order to obtain high resistivity with reasonable bulk and cost, resort is had to mixtures of a good conductor, such as powdered graphite, with insulating binders such as resins and clays, the mixture being subjected to various processes to render it durable. This is the modern method, and, fortunately, the day of the simple graphitic rubbing or painting on a

ends: usually this is done by a metal cap or wrapping of wire, and the application of a hot soldering iron may cause the contact to separate from the element or become loose. Finally, there is a curious electrostatic effect in composition resistors used in high voltage circuits. "Like charges repel . . ." and particles of graphite in the element similarly charged at high voltage may repel each other unless they are very firmly embedded in the binder. This causes the resistance to "go high," and was one of the difficulties that high-voltage television experimenters encountered. With a steep potential gradient through the resistor, too, internal sparking may occur, giving rise to crackles and intense local heat.

LF Transformers and Chokes

Now let us consider coils. Multi-turn windings are not used in modern receivers nearly as much as in early types, and to-day are found only in the form of mains and output transformers. Hence they are not prominent trouble-makers: for that matter, well-constructed transformers and chokes never did give much trouble unless grossly overrun.

Litz wire RF coils can still give rise to loss of amplification if soldered connections are made to their ends, but by fusing the strands together in a small hot gas flame and so welding them to a thicker lead, even this difficulty has been largely overcome.

Failures in iron-cored RF coils can be traced to either the penetration of moisture or to bad winding processes, and

the latter is a negligible factor in the products of reputable firms charging economic prices for their goods. Mass-production winding machines are extremely expensive, and this must be taken into consideration when considering the prices of multi-turn coils: they cannot be efficiently produced at very low cost. Moisture in the windings causes corrosion by electrolysis and the generation of localised heat by leakage currents. Bad construction has the following effects:—

Overrun turns: superimposed layers press hard on the overrun turns to cause the wire to bite through enamel insulation and give rise to a short-circuited turn which, by induction, has excessive current generated in it, causing heat and further deterioration of insulation.

Loose winding: in circuits carrying power, insecure windings may vibrate just as the speech coil of a speaker, and this vibration, though of small amplitude, may rub off the insulating varnish, causing short-circuited turns. This is a very common cause of failure in mains input transformers.

Cheap and nasty varnish: this may contain acid impurities that corrode the copper, absorb moisture, and becomes

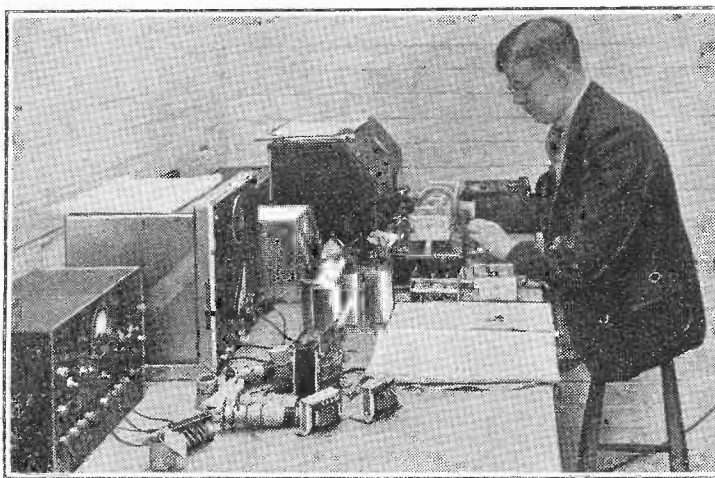

Courtesy Murphy Radio, Ltd.
At work in the Reject Analysis Department of a receiver factory. Here defects are investigated with a view to preventing their recurrence.

stick of pipe-clay has gone: good modern resistors do not now give much trouble if they are not overloaded.

But certain shortcomings in composition resistors remain. For one thing, such mixtures are not very successful as elements in variable resistances, as has been indicated when discussing potentiometer volume controls, for which the element must be thin in order that the moving member can make some approach to contact with the main body of the element instead of merely with its surface. Moreover, certain heat and pressure treatments become difficult when the element must be annular in shape and fixed to an insulating base; thus something in the nature of a mixture of graphite with a gummy self-drying binder must be used. Since the high resistivity of the element is in this case obtained merely by the attenuation of the conducting paths through the body of the resistor, it is difficult for internally generated heat to reach the surface and be dissipated by radiation. Hence composition resistors cannot handle much power without the heat causing changes in the nature of the binder.

Then there is the difficulty of making effective contact with the element at the

Why Components Fail—

brittle and easily cracked after a comparatively short period of use. The varnish will also have been put on unevenly, so that some parts of the wire are insufficiently insulated.

Poor quality flux for soldering fine wire to thicker leads is another common cause of breakdown. The traces of acid left give rise to corrosive electrolysis in use.

The cause of failure in valves depend essentially on construction. Of the purely electrical causes of failure, probably the commonest is the overheating of the filament or cathode. In mains valves, the cathode heats unevenly, so that the full voltages are applied to the HT electrodes while parts of the cathode are still comparatively cool. This gives rise to loss of emission at these parts, since the emissive material on the surface is stripped by the

high voltages. Moreover, the high voltages impart such velocity to the electrons that if there is the slightest trace of residual gas, such as occluded gas or that entering by an ultra-microscopic crack at the sealing of the leads into the glass, ionisation takes place and the cathode surface is disintegrated by bombardment with positive ions. The changes of temperature undergone by the cathodes of mains valves causes the insulation to crack sooner or later, when leakage occurs between the heater and the cathode surface. In battery valves, especially the output valve with its thick filament and high anode voltage, the filament is destroyed by ionic bombardment. In fact, it may be said that the strain put on valve cathodes at the times of switching receivers on and off is responsible for their deterioration more than many hours of steady and continuous use.

On the Short Waves

PREVAILING CONDITIONS ON THE VARIOUS BANDS

AFTER a spell of poor conditions around August 22nd, short-wave conditions improved considerably and at the moment of writing are up to the best sunspot maximum standards. Early on the evening of August 30th, the presumably rather low-angled radiation from the American stations W2XE and WNBI in the 17 Mc/s band was on rather *too low* a frequency for the conditions then prevailing. At 10 p.m. G.M.T. on August 29th, the Rio telegraph transmitter PPX on 20 Mc/s approx. was still an R9 signal.

These good conditions are undoubtedly connected with the presence on the sun's surface of a sunspot covering 800 millionths of its disc during the period August 26th-September 7th. Associated with it was a bright chromosphere eruption of magnitude 3 and August 29th from 08.51 to 10.10 G.M.T.

One effect of these excellent propagation conditions during the "war of nerves" period must not be overlooked, and this is that the B.B.C.'s Daventry transmitters GSE on 11.86 Mc/s and GRX on 9.60 Mc/s during the daytime and GRX and GSA on 6.05 Mc/s during the evening must have been particularly well received in Europe, if not throughout the world. Judging by the signal strength of GSA in London recently, special aerials are probably being employed in connection with the two transmitters regularly employed on this European Service.

To revert to the performance of W2XE and WNBI, one notes that W2XE's new channel is quite clear of interference, and is a big improvement on the old shared channel with DJE, both W2XE and WNBI have been excellent, and have "covered the European crisis" from many angles—especially W2XE.

W2XE's programme during the late evening and early morning of August 29th-30th gives a good idea of how thoroughly European events were handled.

(1) Talk by C.B.S. representative in Paris.

(2) Talk by H. G. Wells and the C.B.S. representative in London.

(3) Talk by C.B.S. representative in Berlin.

(4) Talk by Mr. Douglas Reed, late of London *Times*.

(5) Talk by Dr. Kaltenborn, of C.B.S., from London.

(6) Talk by Y. Masyryk—Dr. Masyryk's son—from London.

(7) Final summing up by Dr. Kaltenborn.

It should be stated that W2XE closes down at 10.00 p.m. G.M.T. on 17 Mc/s and reopens at 10.30 p.m. G.M.T. on 11.83 Mc/s. This latter frequency is also well received, especially after midnight.

Although the American short-wave bands have been dominated completely by W2XE and WNBI, good signals have also been intercepted from WGEA on 15.33 Mc/s (19.56 m. formerly W2XAD) and news from W1XAL on 11.79 Mc/s has also been readable round 11 p.m. in spite of a high level of atmospherics on occasions.

Although the notes above indicate that there has been during the past week at least a temporary return to almost sunspot maximum conditions, it should be borne in mind that the tendency from now onwards will be for the optimum frequencies to get lower and lower and working waves to be longer for any given path and time.

The following quotation is taken from a paper read by D. R. Goddard, of R.C.A. recently, "The British afternoon (television transmissions on 41.5 and 45 Mc/s) programmes between 9.30 a.m. and 11.30 a.m. New York time, could be received at times during certain winter months with some clarity. In the past few years, the latest date for which reception is possible has been steadily receding from March through February to January, and it seems probable that next winter (as the sunspot approaches) no reception at Riverhead of these signals will be possible after December 31st."

With this disappearance of the 7-metre signals we may also expect to see the com-

Henry Farrad's

PROBLEM CORNER

No. 36.—Mysterious Disappearing Trick

An extract from Henry Farrad's correspondence, published to give readers an opportunity of testing their own powers of deduction:—

Rose Cottage,
Nitting Sockbury,
Worcs.

My Dear Henry,

You will be interested to know I have gone in for a new wireless! Well, it *was* getting a bit *passé*, if I may say so; and then when that interesting man spoke some time ago—Mr. Voltson Volt, wasn't it?—and made such queer noises, he quite convinced me that it was time to get a new one. One thing I particularly remembered that he said was if you wanted to get the best results from *all* stations you had to get a set with *Variable Selectivity*, so I made a special point of this when I went to buy mine.

It was a bit rash, I suppose, getting one without asking your advice first, Henry; but it does bring in a wonderful lot of stations when you turn the knob only quite a little way round. I cannot understand what they all say, except that some of them seem very angry. Most of them come in only one at a time, which I am afraid they *never* did on the old wireless! But there is one thing that seems rather queer, and I wonder if you can explain it. The book says that if you want to get the best tone you should have the variable selectivity knob fully to the right; then if you get other stations interfering you turn it to the left until they disappear. Well, I have tried this; and instead of the interfering station disappearing it was the one I wanted that disappeared! Wasn't that a strange thing?

Yours very sincerely,

Jane Stoughton.

Why does the variable selectivity behave in this way, and how can it be put right?
Solution on p. 232.

plete disappearance of amateur 5-metre signals across the Atlantic since all the recorded cases of transatlantic transmission appear to have been via the normal F-layer mechanism, as distinct from the U.S. lower atmosphere transcontinental phenomena of last year. Amateur communication on 10 metres (28 Mc/s) will also suffer to some extent, but 28 Mc/s conditions during the last sunspot minimum showed a peculiar habit of becoming quite good when the sun's face was completely devoid of spots. The reason for this anomaly is not clearly understood and will probably be the subject of further investigation in 1944 or thereabouts. It is just possible that the somewhat higher frequency television transmissions may behave in a similar way, but more erratically.

In conclusion, one notes that W2XE on 17 Mc/s is at the moment giving the latest news summaries in German, Polish, French and Italian, at 9 p.m. G.M.T. The inclusion of Polish is noteworthy and constitutes a precedent.

"ETHACOMBER."

Impressions of Olympia

"DIALLIST" LOOKS BACK AT THE SHOW

HAVING read that there was to be an Export Section at Radiolympia, I saw in my mind's eye a cluster of smallish stands—small because they would display only selected products—presided over by bronzed men well versed in what is needed in the way of radio receivers in the far countries of the Empire, and surrounded by other bronzed men, eager to see the receivers designed for their special requirements. The Export Section, I decided, would contain things of special interest to readers of *The Wireless World*: for the set that will receive Daventry in Canada or Australia or India or South Africa should also be just the thing for receiving Canada or Australia or India or South Africa if used in this country.

Hence, when I had made the first rather rapid preliminary tour that is my wont, I asked a commissionaire if he could direct me to the Export Section, which I hadn't so far observed.

"Couldn't say, sir," he replied; "perhaps this other commissionaire knows. George, where's the Export Section?" But George didn't know. Nor did Charlie when hailed by George, or Bill when Charlie applied to him.

However, I espied the stand of the Department of Overseas Trade and felt sure that they would put me right. They did. If I would but turn about in their doorway where I was standing, there would be the Export Section before my eyes.

It was rather a blow to find that it consisted of a single large stand, at the back of which were a number of show cases. In these were receivers and components; and notices referred one to the main stands of the firms that produced them. I suppose that really it wasn't a bad idea, for you'd only to jot down the numbers of these stands to know where the oversea goods were. But I would have liked to see my cluster of stands, my bronzed men demonstrating and buying . . .

And there was plenty at Radiolympia to have made a full-dress Export Section, or a Long-distance Section—or both. You found that when you came to go round the stands and to examine their wares in detail. I don't know how many sets there were, for instance, in which there were two or more short-wave ranges instead of one, but there were certainly a good few.

Short-wave Sets

Some time ago I wrote that the tuning of the "all-wave" receiver with a single short-wave range and no kind of band-spreading arrangements was apt to demand more patience than its owner might care to devote to searches for stations on wave-bands such as the 16-metre, the 19-metre and the 25-metre. There are welcome signs that designers have realised that if they

want short-wave reception to be popular they must make it as easy as the price of the set will allow.

One receiver has gone the whole hog. It covers only the 13-, 16-, 19-, 25-, 31- and 49-metre bands and none of the intervening wavelengths. But it devotes a full-scale sweep to each of these six bands; and what is more it bears the actual names of over 100 short-wave stations, whose exact setting are marked on the scales.

In a word, it aims at making the reception, not only of WGEA, WCAI, XGOY and other strongly received short-wave stations, but also of dozens of the smaller fry as easy as that of European medium-

the markets of India and other countries, where wavelengths of that order are authorised for the internal broadcasting services. In this country such a range has its uses, for it takes in two amateur bands and yacht telephony.

Some time ago numerous readers corresponded with me on the subject of really universal sets: sets that would work equally happily on AC mains, DC mains or batteries. There was a most ingenious portable on these lines at the show. The "working" valves are of the battery low-voltage low-current filament type. Their filaments are arranged in parallel when the batteries are in use, but in series for mains heating. The dry batteries used are contained in one and the same cardboard case, and both LT and HT connections to them are made by means of a 4-pin plug and socket. Grid biasing is automatic.

One striking demonstration given to me by the designer was to insert the mains plug into its socket and switch on. The set came to life instantly, the batteries doing

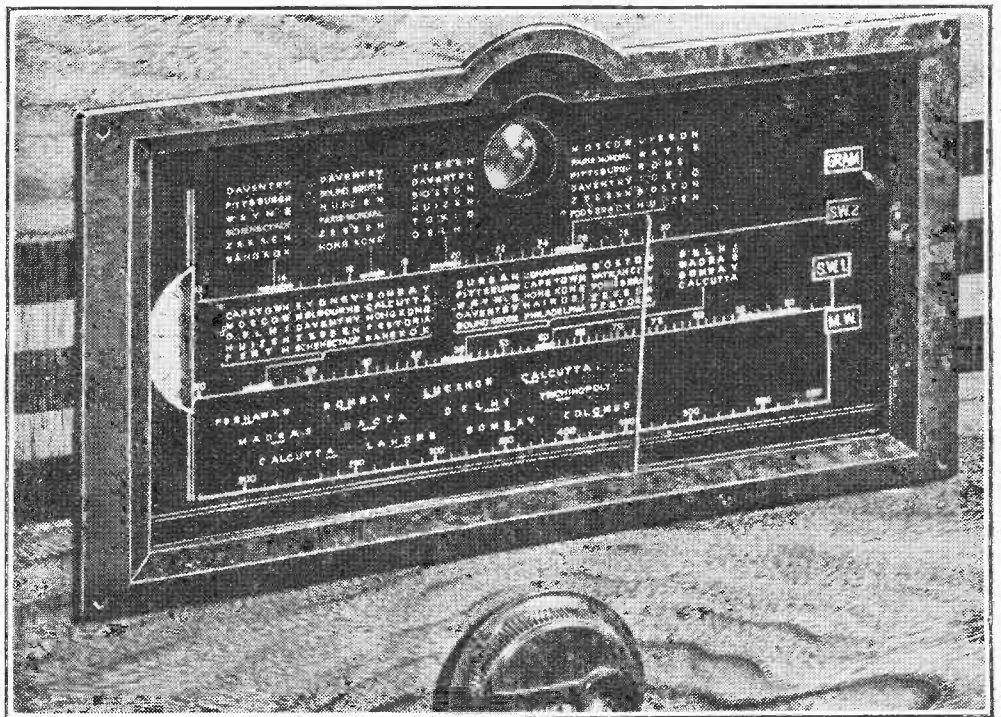

An Export Section exhibit. The tuning scale on the Marconiphone Model 808 universal six-valve superheterodyne is calibrated with the names of 12 Indian stations on the medium-wave band which covers 200-580 metres. The shorter wavelengths are covered in two ranges 13-30 and 30-90 metres. It is adjustable for any mains voltage between 105-255. Tuning is made easy by the incorporation of the Thaumoscope visual tuning indicator.

wave stations. That is indeed a laudable effort, and I look forward very much to trying one of these sets a little later on.

I was much attracted by the ingenious methods used by other designers. Some employed band-spreading of one kind or another; others pinned their faith to bigger and more clearly marked dials with finer pointers than in the models of yester-year; others, again, were waging war against second-channel "images" and whistles by the use of signal-frequency stages.

All of the "all-wave" models shown by one firm had a range of from 50-150 metres. These, I take it, are made with an eye to

duty until the rectifier had warmed up to a certain temperature. When that was reached, there was a slight click: by means of a relay the batteries had been cut out and current from the mains cut in. If the mains current was switched off, the relay immediately brought the batteries into action again.

I'm not sure that that principle isn't worth adapting to sets other than portables. Is there anything more annoying than when you suddenly realise that some item you specially want has just begun, switch on and have to wait what seems hours for the heaters to warm up?

Impressions of Olympia—

I don't know if I was specially lucky, but I seldom had any difficulty in finding at the stands I visited someone who would deal with technical questions. In past years one has too often found, on returning hopefully at intervals to a stand where there was something of particular interest, that the only technical man provided appeared to start on tea as soon as he had finished his lunch and on dinner the instant his teacup was empty.

Makers have realised that what the great public is yearning for above all things in their receivers is reliability. At stand after stand I was told of the steps that had been taken to ensure it, and of the amazingly complex tests to which sets are subjected before they leave the factory. The lessons of the past have been taken to heart, and I do think from what I saw of the insides of sets and of the components therein that real progress has been made in this respect.

Another thing that impressed me was the stress laid by many firms on the quality of the reproduction given by their better models. And, listening to the questions asked by Mr. and Mrs. Everylistener, I found something of a change there also. The first enquiry always used to be: "Will it bring in every station in Europe?" or "Will it get America?" This year I heard many lead off with questions about the reproduction of the local stations' programmes, absence of hiss, hum, other hateful background noises, and so on.

"The Services' stands were of considerable interest." This portable ground station, which was among the interesting apparatus to be seen on the R.A.F. stand, consists of the transmitter and receiver as used in a 'plane. Complete with message pad, key and 'phones, they are fitted into a metal cabinet the front of which is covered by a drop sheet.

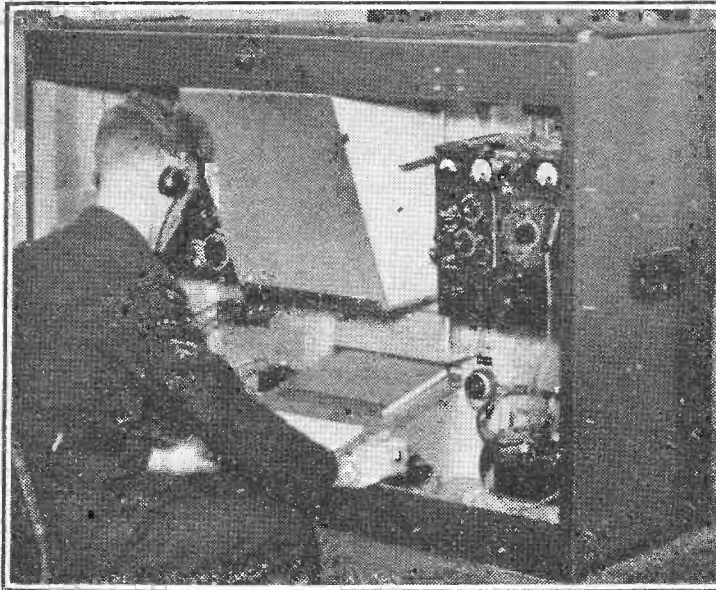

Radiolympia 1939 was certainly the most stunt-free exhibition that I can remember. And that, I feel, is a very good sign. Manufacturers had come down to brass tacks and were showing the public what the public had come to see.

No Longer a Marvel

They had come to see television receivers as well as wireless sets. There wasn't much doubt about that. And my impression, from what I saw and heard here and there, was that the period of mere marvelling at television was over: the enquirers were fully alive to the entertainment value of television, and most of them were seriously considering the installation of receivers in their homes, if they hadn't already made up their minds to do so.

The Services' stands were of considerable interest, though the organisers of each were naturally much handicapped by not being able to display devices that would indeed have produced thrills! But what they gave

us was enough to show that they aren't exactly behind the times. Something more than a word of thanks is due to the able and most willing demonstrators on all these stands.

There are, those, and I am one of them, who lament that the fun-fair side of the Exhibition was so strongly stressed in the advertisements of Radiolympia. These urged you to come and be televised, to visit Miss Radiolympia's boudoir, to see the stars in the theatre; they also mentioned that there were wireless sets and television receivers on view. It was the worst of bad luck that the Exhibition should coincide with the crisis. But for that, I feel that it could well have stood on its own feet as a radio show, without the help of the boudoir or the great bowl theatre. The purely technical "sideshows" always seemed to be well patronised, and it was noticeable that many of the visitors were professional wireless people.

HENRY FARRAD'S SOLUTION

(See page 230)

IF the instruction book is correctly quoted by the correspondent, it is not a very good one. Stations should be tuned in first with the *greatest* selectivity, and the response then broadened out if conditions

permit. If a station is tuned with least selectivity, it is difficult or even impossible to do so accurately. Especially is this so if the variable selectivity is not much more perfect than is often the case. A common fault is that the response curves at the extremes of the selectivity control are something like those shown here. When tuned at the least selective setting it is natural to bring the wanted station, W, in line with the peak. If the frequency separation of an unwanted station is represented by that between W and U, it is likely that some interference from U will be heard. If the selectivity is increased to get rid of U, it can be seen that W will be cut out and U remain almost unaffected.

Although this asymmetrical broad response curve is not ideal, the system could at least be made to serve its purpose by tuning with maximum selectivity. W would then come where U is shown, and U would be excluded. Conditions permitting, the best would also be obtained from the wide response adjustment.

Theory and Design of Valve Oscillators, by H. A. Thomas, D.Sc., M.I.E.E. Pp. 270+xvi. Published by Chapman and Hall, Ltd., 11, Henrietta Street, London, W.C.2. Price 18s.

THIS book is Volume VII of a series of monographs on electrical engineering and deals very thoroughly with the problems associated with valve oscillators. Fundamental principles are treated in the first chapter and types of oscillators and the conditions for oscillation in the second. Here the close relationship which exists between many apparently dissimilar circuits is well brought out by their derivation from a single prototype. The dynatron and multi-vibrator are not omitted, and in Chapter III the efficiency of oscillators is dealt with in some detail.

This occupies 76 of the 270 pages, and apart from the bibliography and index the rest of the book is devoted to the problems of frequency stability in one form or another. There are chapters on frequency drift due to the valve, to the effect of temperature on the coils, the effect of temperature on condensers, as well as the stabilisation of the maintaining system, the inductance, and the capacity. The book concludes with a chapter on methods of obtaining automatic frequency stabilisation.

Crystal-controlled oscillators are not treated, the discussion being confined to uncontrolled oscillators. Among the methods of stabilising the valve circuit, it is shown that much can be done by the choice of suitable circuit values. The author gives a list of seven principles, which are not mutually exclusive, by the observance of which a considerable improvement can be obtained. Special circuits, such as the Franklin oscillator, the phase-compensated oscillator, the line-stabilised oscillator, the Kolster high-Q circuit, and the Dow circuit, are dealt with.

It is often believed that frequency variations are due chiefly to the valve and the voltage supplies. The author shows that while they undoubtedly affect the frequency appreciably, the effect of temperature on the coils and condensers is often much greater. The chapters dealing with the stabilising of inductance and capacity are thus especially important.

The book is admirable for its lucidity and accuracy. The treatment is often mathematical, but it is rarely necessary to follow the equations in order to obtain a qualitative understanding of the subject. The book is consequently of considerable value to the non-mathematical, and can confidently be recommended to all interested in this important subject. W. T. C.

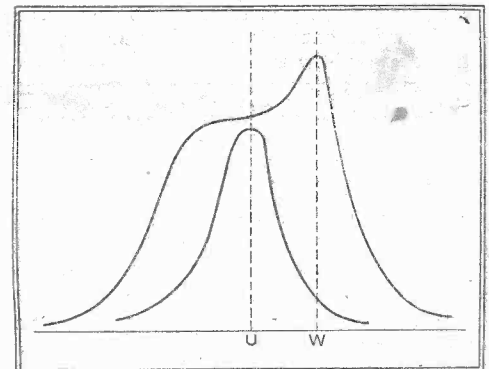

Typical resonance curves for alternative settings of a selectivity control.

6^D

The Wireless World

THE PRACTICAL RADIO & TELEVISION JOURNAL

Thursday, August 10th, 1939.

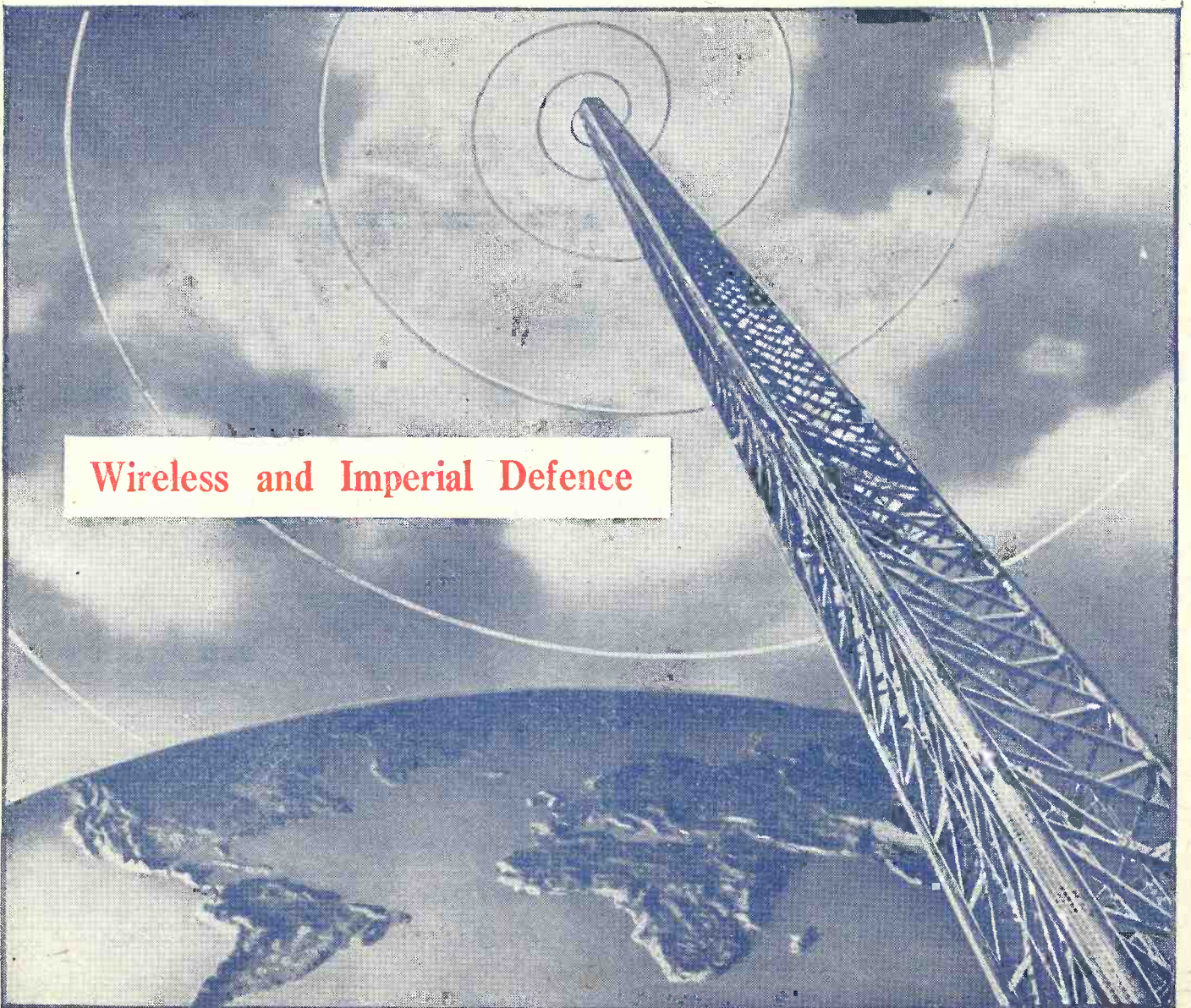

Wireless and Imperial Defence

20 ————— 20,000 CLASSIC QUALITY AT A REASONABLE PRICE!

The 346 type Amplifier is "engineering built" to the same high standard as our famous 4/12 watt model, and in spite of its reasonable price is, as the curve shows, capable of giving an equally good performance. Like the 4/12 watt model, the smaller Amplifier has become a classic among Amplifier connoisseurs. The specification includes: 036 type special output transformer, balanced bias with vernier adjustment, self-contained smoothing and volume control. We feel sure that you will agree as a result of a demonstration that the 346 type Amplifier priced at £10 represents a definite Challenge to anything on the market, and upholds SOUND SALES Quality Claims in every respect.

May we send YOU a copy of our latest catalogue and Technical manual? PRICE **6d.**

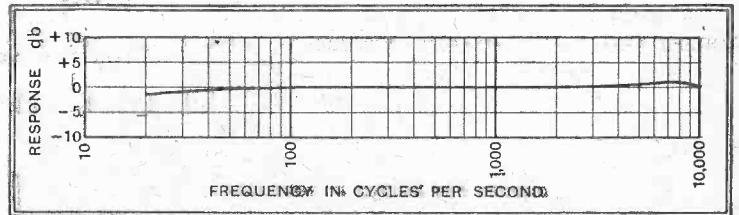
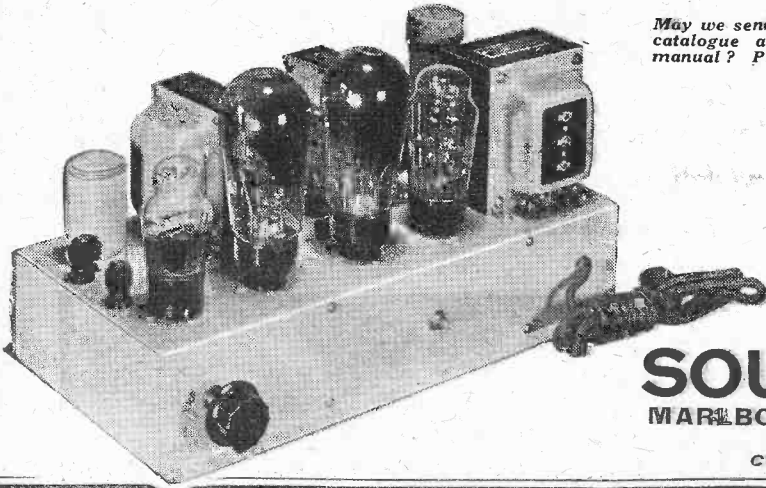

SOUND SALES LIMITED

MARLBOROUGH ROAD, UPPER HOLLOWAY, LONDON, N.19

Telephone: ARChway 1661-2-3.

Contractors to the G.P.O., Air Ministry, War Office, etc.

B.I. COPPER EARTHING RODS

for
WIRELESS
APPARATUS

(U.K. Patent Nos.
438508, 423885, 430040.)



**100%
MORE
SURFACE
AREA**

Designed to give a low resistance earth contact. Made from solid drawn H.C. copper. The multiple fins ensure larger surface area and better contact with the earth than any driving earth of similar diameter and weight at present on the market; giving nearly 50 per cent. more contact area than a circular rod of equal diameter, or 100 per cent. more than a solid rod of equal weight.

About 1 1/2" of the rod is left exposed and the earth lead is simply clamped against the rod by means of the copper clamp ring and screw. No sweating or soldering is required. Supplied in two standard sizes, 18" and 24". Longer rods of similar type can be supplied, if desired, to meet special requirements.



BRITISH INSULATED CABLES LTD.
CABLE MAKERS AND ELECTRICAL ENGINEERS,
PRESCOT, LANCS. Tel. No. PRESCOT 6571

The ELECTRICAL REVIEW

The Complete Technical Journal

Practical articles on all aspects of electricity supply and utilisation—industrial, commercial and domestic. Latest news of the electrical industry and developments. Advertisement pages form a comprehensive buyers' guide.

Contents of August 11th issue

ELECTRIC MOTOR SURVEY

The first of a series of articles based upon an extensive investigation.

CABLE MAKING IN SCOTLAND

New industry at Renfrew.

SUB-STATION PLANNING

Forecasting future requirements.

ELECTRONIC WATTMETER

Its use in power wave-form delineation.

EVERY FRIDAY 6d.

Subscriptions: United Kingdom £1 14s.
Canada £1 12s. Other Countries
£2 1s 6p per annum, post free.

ELECTRICAL REVIEW LTD.

Dorset House, Stamford Street, London, S.E.1

Mention of "The Wireless World," when writing to advertisers, will ensure prompt attention.

The Wireless World

THE
PRACTICAL RADIO
JOURNAL
29th Year of Publication

No. 1041.

THURSDAY, AUGUST 10TH, 1939

VOL. XLV. No. 6.

Proprietors : ILIFFE & SONS LTD.

Editor :
HUGH S. POCOCK.

Editorial,
Advertising and Publishing Offices :
DORSET HOUSE, STAMFORD STREET,
LONDON, S.E.1.

Telephone: Waterloo 3333 (50 lines).
Telegrams: "Ethaworld, Sedist, London."

COVENTRY: 8-10, Corporation Street.
Telegrams: "Autocar, Coventry."
Telephone: 5210 Coventry.

BIRMINGHAM:
Guildhall Buildings, Navigation Street, 2.
Telegrams: "Autopress, Birmingham."
Telephone: 2971 Midland (5 lines).

MANCHESTER: 260, Deansgate, 3.
Telegrams: "Iliffe, Manchester."
Telephone: Blackfriars 4412 (4 lines).

GLASGOW: 26B, Renfield Street, C.2.
Telegrams: "Iliffe, Glasgow." Telephone: Central 4857.

PUBLISHED WEEKLY. ENTERED AS SECOND
CLASS MATTER AT NEW YORK, N.Y.

Subscription Rates :

Home and Canada, £1 10s. 4d. ; other
countries, £1 12s. 6d. per annum.

As many of the circuits and apparatus described in these
pages are covered by patents, readers are advised, before
making use of them, to satisfy themselves that they would
not be infringing patents.

CONTENTS

	Page
Editorial Comment	115
Super Receiver : More About the MUSA Transatlantic Tele- phone Receiver	116
Wireless and Imperial Defence ..	119
Problem Corner	120
Parasitic Oscillation in Frequency Changers	121
Television Programmes	124
News from the Clubs	124
New Apparatus Reviewed	125
Unbiased	126
News of the Week	127
High-Voltage Problems—II: In- sulating Materials and their Properties	129
Random Radiations	131
Modern Detector Circuits	132
"Wireless World" Pre-Tuned Quality Receiver	135
Letters to the Editor	136
Five-metre-DX	137
Recent Inventions	138

EDITORIAL COMMENT

Circuit Diagrams

A Plea for Standardisation

GRAPHICAL symbols as used in wireless circuit diagrams have now become as nearly standardised as need be; a number of inconsistencies that formerly existed were cleared up by the publication nearly three years ago of a British Standard Specification. Differences of opinion may still exist in matters of detail, but the symbols generally employed in published diagrams are, with a few unimportant exceptions, sufficiently alike to be easily recognisable.

It is unfortunate that the same unanimity does not exist with regard to the layout of the diagrams themselves. Wireless apparatus generally, and especially receivers, tends to become more complicated, and anything that helps to make circuit diagrams easier to understand is highly desirable.

So far as *The Wireless World* is concerned, our first aim is to make diagrams easy to read, even if this involves some sacrifice of compactness or even of symmetry. The object in view is best attained by arranging the component symbols in such a way that there is an orderly progression from input to output.

It is equally important that those who "read" the circuit diagrams should know where to look for the features with which they are at the moment concerned, and it is for this reason that the layouts have been standardised as far as possible. For example, in receivers and amplifiers the aerial or other source of input is on the extreme left, with the output on the right; this procedure is naturally reversed in the case of transmitters.

Another detail that, we hope and think, makes for greater clarity is the arrangement in a straight line of

all valves in the direct signal path. Valves performing subsidiary functions, such as that of tuning indicator amplification, AFC or AVC, are placed above or below the line as is most convenient. A necessary exception to this rule occurs in the case of pairs of push-pull valves. Power rectifier symbols are inverted to avoid confusion with other valves.

A thickened earth line at the bottom of the diagram, with the HT 'bus-bar' at the top, seems to make a clearer diagram than some of the alternative arrangements, and we always prefer the practice of taking all earth leads direct to the base line instead of using supplementary earth symbols.

Much of the time now wasted in unravelling the intricacies of circuit diagrams would be saved if a standardised method of presentation were universally agreed and adopted.

Standard Time

B.S.T. or G.M.T. ?

ONE of the minor problems that perplex those of us whose task it is to record events in the world of wireless is the choice of standard time. Radio communication is such an all-embracing and international affair that to use British Summer Time seems to suggest a narrow parochial outlook, while the alternative of Greenwich Mean Time is apt in certain contexts to confuse those who are at the moment concerned with happenings at home. *The Wireless World* has therefore adopted a compromise, taking due care to avoid any risk of puzzling readers either in this country or abroad. While Summer Time is in force, B.S.T. is used in reference to purely domestic or local events. G.M.T. is reserved for matters of wider interest, and when this standard is employed, the fact is noted in the text.

Super Receiver

A FEW months ago I explained the general idea of the "Musa"—a special aerial system (Multiple-Unit Steerable Aerial) for selecting any particular downcoming ray of waves. It is being installed to maintain the transatlantic telephone service when conditions are too bad for even the elaborate receivers used hitherto. The trouble, you will remember, is that long distance short-wave signals generally arrive at several different angles, usually between about 5 and 30 degrees above the horizontal. These are as likely to cancel out as to reinforce one another, and the result is a very troublesome form of fading. But transatlantic telephony ought to be even clearer than local calls, because (as it has been put) "of differences in language habits." The Musa consists of a string of separate rhombic (i.e., diamond-shaped) aeri-als, connected up and combined in such a way that by operating a control in the receiver it is possible to adjust the angle of reception to accept the strongest ray that is arriving. If there are other reasonably good rays, they can be combined too; but they must be made to keep properly in step, not just anyhow.

Since my last writing, the Post Office Musa station has been got going on one

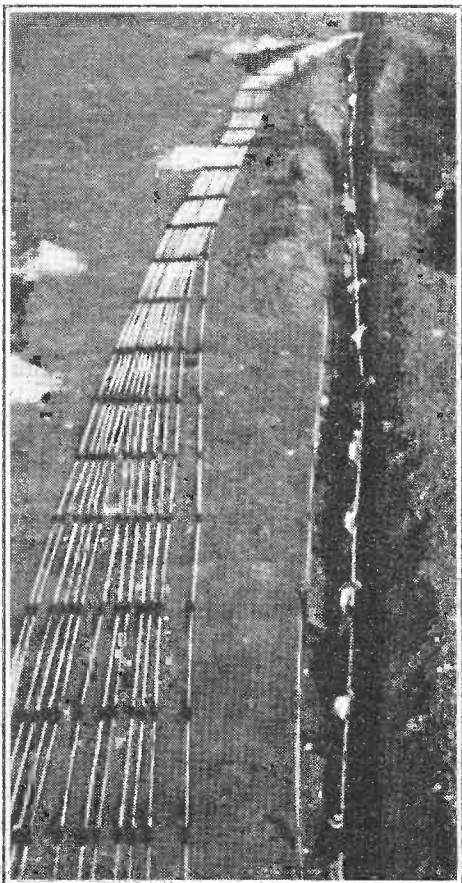

Burying coaxial cables used to connect the sixteen trapezoidal aeri-als of the Post Office MUSA system at Cooling to the receiver described in this article.

More About the MUSA Transatlantic Telephone Receiver

By "CATHODE RAY"

cylinder, so to speak, and ought to be ready for service soon; some more information on it now may be of interest. I am only sorry that even if I were allowed the whole of an issue of *The Wireless World* it would almost certainly be insufficient space in which to explain this ingenious receiver in detail. There is a paper on it in the February, 1939 issue of the *I.E.E. Journal*, but it demands a good deal more concentration than I like to ask of the majority of my readers. Although the full beauty of the working cannot be seen from the following few notes on it, they may help to give some idea of how a job like this compares with what you have at home.

Although the station is barely 30 miles from London and within sight of the Thames, it is tucked away in a very unfrequented part of Kent, and airmen are the only people likely to find the aeri-als conspicuous, even though they do extend for two miles. They are on a dead flat piece of land—Cooling Marshes—north of Rochester, and have been laid down exactly on a great-circle bearing on the American transmitter. There is a similar receiver over on the other side of the Atlantic trained on Rugby. The ground has to be flat, of course, for keeping the aeri-als exactly in a straight line; and as it is marshy it is highly conducting. In fact, if it were not for protecting walls it would be flooded at spring tides. As each aerial has to be connected to the receiver by a separate transmission line, there are 16 miles of them buried in the ground. To keep moisture out, dry air is pumped in; and the problem of tracing leaks in this vast length looked serious until (as the lay Press has reported) someone hit on the idea of pushing in smelly air of a nature specially attractive to a dog kept for the purpose of locating escapes by digging at the appropriate spot.

1,079-valve Receiver!

The receiver itself, which you remember is a 1,079-valve model, occupies (when finished) panel space 8 feet high by 110 feet long, so does not come within the portable class. Actually the equipment is duplicated, so comprises two complete receivers, and each receiver is arranged to handle two speech channels simultan-

ously at present and perhaps as many as six later on. Instead of using both sidebands for one channel, as in broadcasting, each sideband carries a separate conversation; and the transmitted carrier wave itself is reduced to a mere ghost, but enough to be amplified up separately and used to control the frequency and amplification in the receiver, as well as being reintroduced later to perform the essential duty of a carrier wave in combining with the sidebands to give an undistorted output.

Seeing that *Wireless World* readers are apt to look down on sets without a pre-selector stage, and the better "communication" receivers have two, it is rather startling to find that the great Musa receiver (which one might reasonably expect to have half a dozen at least) has none at all! It fully makes up for this, however, by its profusion of frequency changers, having three stages of them totalling (as nearly as I can calculate) 200 frequency-changer valves for the pair of receivers, not counting the separate oscillator valves and oscillator amplifiers. You see, the sixteen aeri-als each have what are in effect separate receivers for a large part of the way, and the first frequency changer uses pairs of hexode valves in push-pull; that makes 32 for a start, doubled for the spare receiver.

A receiving circuit on this scale may

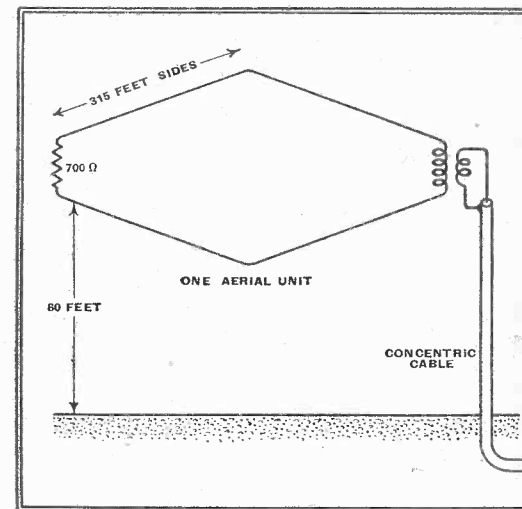

seem too complicated to follow; and it certainly would be if all the various aerial and channel branches were included in a single diagram. But the biggest bundle of sticks can be broken if they are taken one by one. Fig. 1 is a block diagram of one signal path through the receiver from one aerial, showing the various stages and frequency changes. The rest is mainly repetition of identical equipment. One single path like this may not be so much more complicated than a modern broadcast receiver as to be beyond following. Let us try.

With three frequency-changer stages

there are, of course, three IFs: 3,100, 600 and 100 kc/s. This is not just for prestige; each of these stages has a special purpose to serve, in connection with the aerial combining and channel separating, and the tuning arrangements. Besides that, the high first IF avoids the image interference that one might fear with no pre-selector amplifier; and the low third IF gives good adjacent channel selectivity.

Beginning at the beginning, with the lead-in from an aerial; any of five alternative transmitter frequencies can be selected by ganged switches connecting the appropriate aerial tuning circuits and first beat oscillators, which are designed to convert all their frequencies to the 3,100-kc/s first IF. From this stage onwards all signals are at the same frequencies regardless of the frequency of the transmitter being received.

As the first beat oscillators are crystal controlled, the oscillator amplifier is not there for the purpose of preventing the frequency-changer influencing the oscillator frequency; its real necessity, not disclosed by this simple diagram (but see Fig. 2 in due course), is that this is only one of 16 frequency changers to be fed in parallel, one for each aerial.

Next the first IF amplifier, with its tuning circuits; only one stage, so not very spectacular. The second beat oscillator works at only one frequency, of course, 2.5 Mc/s; but this is variable, being the only tuning control in the whole receiver, apart from the ganged switches. It is hardly a station searcher, however, for the variableness is only about 3 kc/s each side! One feature of this type of receiver is the accuracy of tuning. It is kept

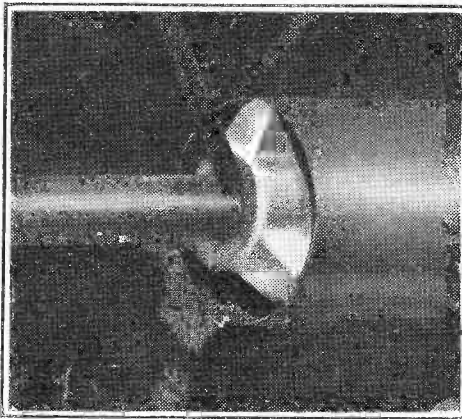

Close-up of one of the coaxial cables before anchoring flanges were put on, showing porcelain insulator and inner copper tube. This and the previous photograph were supplied by the Post Office Film Unit.

accurate by AFC. But the ordinary AFC as used in some broadcast receivers is not good enough—not by a long way! That is thought to be working quite satisfactorily if it keeps the tuning within about 1 kc., even on medium and long waves. On short waves it is sometimes better not to enquire too closely what it does. But the Musa short-wave receiver has to be correct within a few cycles! The standard is a special 100-kc/s crystal-controlled oscillator. The AFC control valve is simple enough, but the single box I have marked "Discriminator" is not the usual double diode valve and special IF transformer; it should really be represented by a whole collection of boxes, containing oscillators, frequency changers, and, in fact, as much as a whole little receiver on its own.

As the received carrier wave is so weak, compared with the sidebands, it has to be taken through a separate amplifier. Before we get to that, however, there is the third frequency changer. The oscillator for this is rather novel, for instead of being independent it is locked to the 100-kc/s standard by being derived from its fifth harmonic. Three things emerge from this third frequency changer—a sideband of 94-100 kc/s comprising one channel of communication; a sideband of 100-106 kc/s, the other channel; and the diminutive "pilot" carrier wave, 100 kc/s. These are all separated by extraordinarily efficient filters—the carrier filter, for example, cuts off sharply at only 20 cycles off tune (no wonder accurate tuning is needed!). This carrier has to be amplified before it can be detailed to its various jobs—(1) AVC, acting on the 2nd IF amplifier; (2) frequency control, acting on the 2nd beat oscillator as already described; and (3) recombination with the two detached sidebands to give audio outputs. Only the lower frequency channel is shown in Fig. 1—the other is identical.

The apparatus included in this diagram is in itself a complete receiver—and an exceptionally elaborate one—but in running through it I have had to skip one or two items that only make sense in relation to the super-receiver of which this is one unit. The most important of these is the phasing control (just below the second frequency changer), which is another of the units that comprises a whole collection of things. I am not at all sure that if a whole article were devoted to this one "box" it would be enough to make it

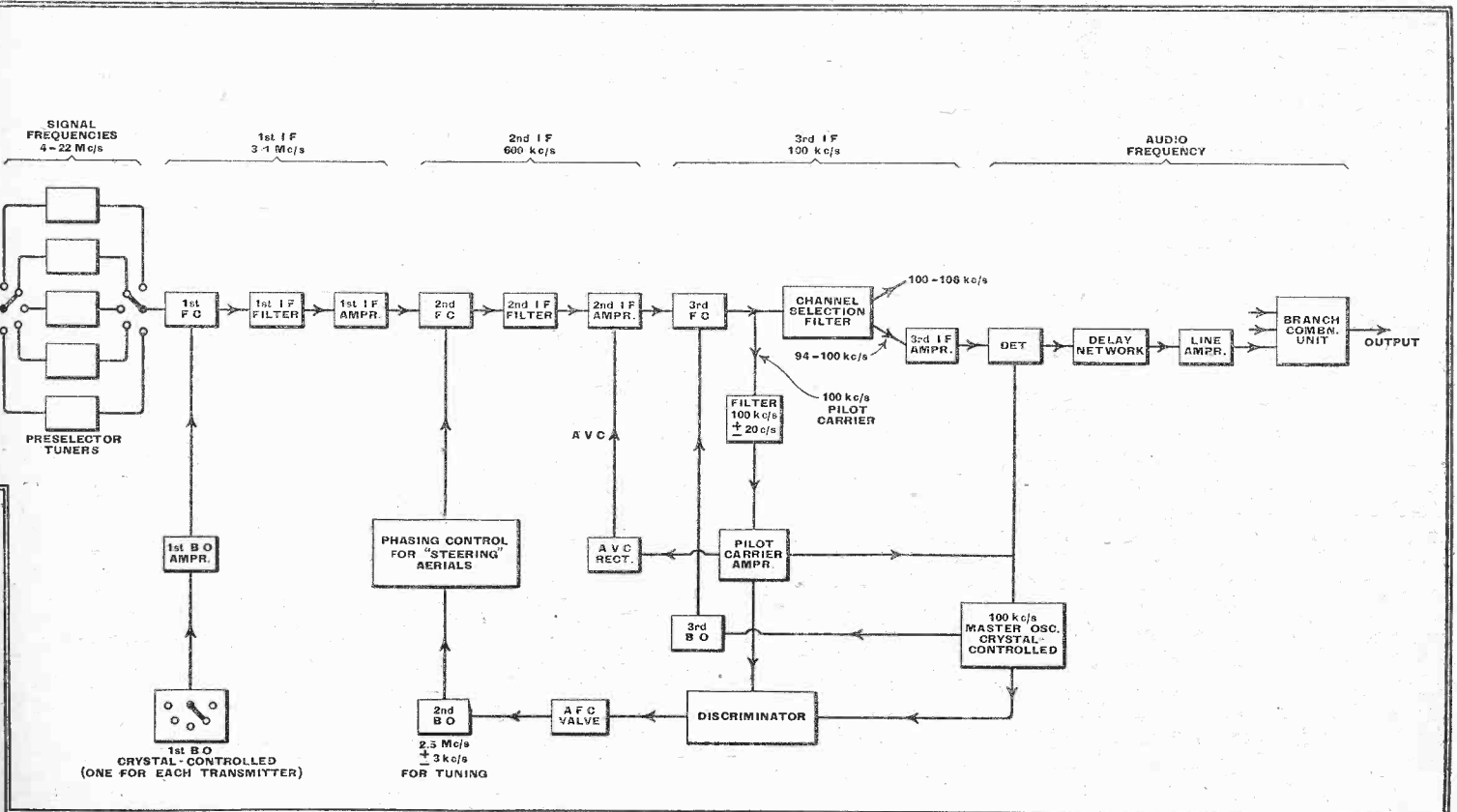

Fig. 1.—One complete receiver path from aerial to output. The direct signal path runs across the top of the diagram: the parts hanging from it are heterodyne (beat) oscillators and other frequency controlling accessories. Some of these are very complicated. Abbreviations: FC, frequency changer; BO, beat oscillator; IF, intermediate frequency; AFC, automatic frequency correction; AVC, automatic volume control.

Super Receiver—

clear, so I shall just say that it is an artificial "line" tapped at 16 points for the output from the second beat oscillator to be drawn off at different phases for the 16 separate receivers of the Fig. 1 type, these phases being under control. This is the control that makes it possible to adjust the angle at which the whole aerial array receives. At other angles, the phases at which the signals arrive, after combination by the controllable phase changer, are such as to cancel out, more or less; so reception is excluded. The signals received by the 16 aerials from the desired angle all add up together to give a correspondingly useful total, which from the secondary frequency changer onwards is combined.

But there is one more "dimension" in which this receiver is split up along multiple paths. The system just hinted at is responsible for combining the 16 systems, each running from an aerial to a second frequency changer, to give a strong signal at any desired angle. But this is only one of four angles that can be selected. There are four sets of 16 phase controls, each of the four adjustable to a different angle, and taken to one of four separate outputs from the first IF amplifier. Three of these four can be trained on separate angles of reception, if desired; and the fourth is a "monitor" which continually sweeps over the whole range of angles and is connected to a cathode-ray tube where the angles of strong reception

guessed, concerned with the combination of the signals from the three best angles. The last box of all needs no explanation; but the "delay network" is a device for introducing a controllable amount of slowing-up in the three branches so that they combine in step, just as converging files of troops may have to do a little holding back or half stepping before forming a column. The necessary adjustments again are indicated on a cathode-ray tube.

Having examined one path we can stand

is sent steadily and clearly to the international exchange in London; and the listener has no idea of how the fluctuating beams of waves are being caught in 16 nets, sorted out, brought into step, and combined; guided and marshalled by tier upon tier of crystal-controlled oscillators and razor-sharp crystal filters kept to an accuracy of a few parts in ten million. One feels that it is almost a desecration to command all this for anything less than the sublime!

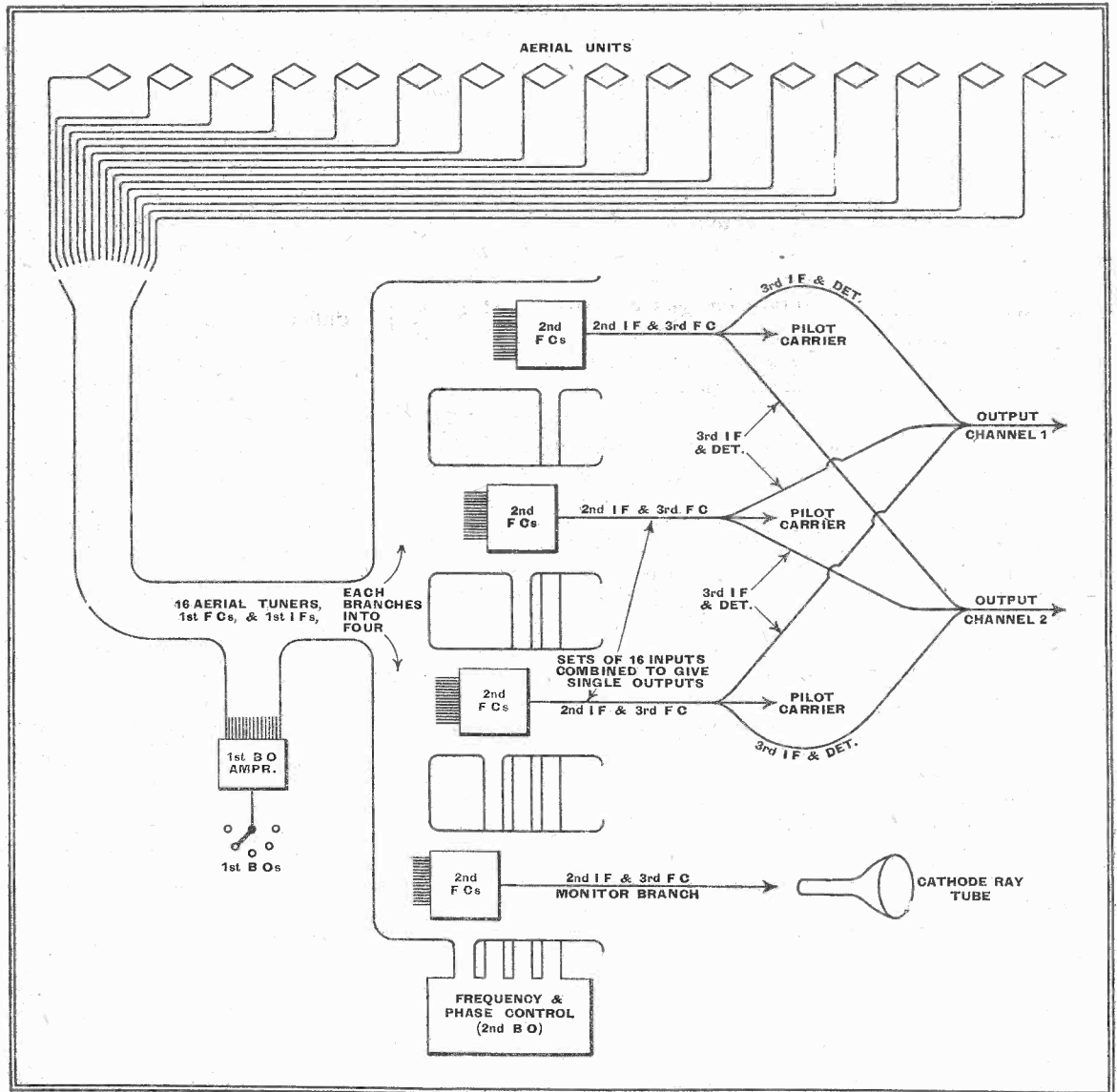

Fig. 2. How receiver paths, such as the one shown in Fig. 1, are bundled together, branching out and recombining, to obtain the special advantages of the Musa system.

are shown. The operator can then adjust the other three to select one, two, or three of these angles, depending on whether or not they are good enough. Of course, there is no point in using all three if one or two of them bring in shifting, noisy signals. Just to make the whole affair even more superhuman than it is at present, the G.P.O. research people are busy on an arrangement for automatically keeping the three phasing controls adjusted to the best angles, as found by the monitoring fourth. I should perhaps have reminded you that the downcoming rays are constantly changing in angle and strength, so the controls cannot be left alone after having once been set.

The remaining boxes, at the extreme right of Fig. 1, are, as you will have

back for a bird's eye view of the two complete super-receivers, Fig. 2, in which the detail has been stripped still more cleanly, leaving only single lines—or even less—to represent what is shown in Fig. 1. The aerials have been bent back on top of the receiving station for the sake of compactness. From Fig. 2 it ought to be possible to get a general idea of how by the splitting and recombining that has been described the number of paths varies from 16, to 64, to 4, to 10, to 6, and to 2. Various interconnections, such as those leading from the carrier-wave paths, are left out.

And so all the complexity finally boils down to two outputs, from which the voice of some film star or business magnate, or perhaps our own King or Queen on tour,

The Wireless Industry

A FOLDER describing the new season's K-B receivers has now been issued by Kolster-Brandes, Limited, Cray Works, Sidcup, Kent. Features of the new models are: Peer-less giant tuning dials, variable selectivity and extended AC voltage range (100-250 V).

Charlton Higgs receivers are now obtainable from Frederick Waterhouse, Limited, Stanley Works, Dudley Hill, Bradford, Yorkshire.

The Grampian works reopen on August 12th after the annual holiday.

A leaflet just issued by Salford Electrical Instruments, Limited, of Peel Works, Silk Street, Salford, 3, Lancs, describes a new Salford Link Test AC ammeter; the length of the almost circular scale (about 300 degrees) makes for exceptional accuracy in reading.

Wireless and Imperial Defence

MAINTAINING COMMUNICATION IN TIME OF WAR

AT the present time, when the tense international situation has become such a dominant factor in our everyday life, it may not be out of place to review the great part which communication, and, in particular, radio communication, plays in the vital question of Imperial defence. In this connection the term "Imperial defence" is used in its wider sense, implying the defence of the whole British Commonwealth of Nations rather than of the British Isles alone. The importance of rapid and reliable direct communication between London and the various Dominion and Colonial Governments can hardly be exaggerated. In fact, it is no mere figure of speech to say that,

It is generally conceded that, great as was the part which wireless played in the Great War, its importance would be far greater in any future emergency. Since 1918 great strides have been made in technical progress, and broadcasting with its immense potentialities for propaganda has come upon the scene; in addition, wireless and cable interests have been amalgamated to their mutual advantage.

in the present unfortunate circumstances, the very existence of the Empire depends, to a large extent, on its communications. The rapid interchange of views between the Home and the Dominion authorities, important as it is in time of peace, would become of infinitely greater importance in the event of war.

So great has been the development of radio engineering during the past decade that there is a somewhat excusable belief amongst the general public that wireless is now the sole channel of long-distance communication. Readers of *The Wireless World* will, of course, know that in the same period the advances in cable technique (and this includes ordinary land line telegraphy and telephony), while, perhaps, to the lay mind less spectacular and, therefore, less advertised by the daily Press, have, nevertheless, been almost equally rapid and far-reaching in their own sphere.

In any survey of Empire communications the relative roles played by both wireless and cable systems should, therefore, be considered since it must be appreciated that, from the defence point of view, they are, in effect, sister services each of which has certain advantages over the other, resulting in their joint use and co-operation. To understand why such co-operation is necessary we must first examine briefly

the disadvantages of the cable system.

Although something like 60 per cent. of the world's cables are British, their effectiveness may be very seriously impaired in time of war for the following reasons. Inter-continental cables, of necessity, lie on the bed of the ocean for by far the greater portion of their route, and, therefore, rely upon sea power for their protection against enemy action. Great

Britain still remains the world's paramount sea Power, but, even so, the very vastness of our Empire makes it extremely difficult to prevent isolated raiders from cutting, and, in some cases, lifting a cable. Particularly is this danger apparent during the opening phases of hostilities. Again,

many cables which are owned or controlled by British interests either touch, or even pass through, foreign territory. Though such countries may, and probably would, be neutral, this is a grave potential source of leakage of information, since it may be difficult to ensure a watertight censorship of such stations.

These cables would probably not be used for confidential official traffic in wartime, and reliance would be placed almost entirely upon what is known as the "All Red Routes," that is to say, on those cables which throughout their route touch only at British territory. This would

By G. L. MORROW

graphical factors, many cables are particularly prone to the danger of attack by land. Perhaps the best example of such are the land lines linking the Mediterranean and Far East systems between Alexandria and Suez.

Such then are the chief disadvantages of the cables, and it needs no technical knowledge to realise that radio communication is almost free from such defects, although, of recent years, the possibility of intensive air attack on the terminal stations in the British Isles has had to be considered more seriously than was the case during the war of 1914-18.

Wire or Wireless?

At first sight, therefore, it would appear reasonable to regard radio as the ideal method of Imperial communication. What must not be forgotten, however, is that such communication is to a large extent governed by the exigencies of strategic problems, and that, in this respect, wireless unfortunately suffers from the grave disadvantage of lack of secrecy. Before, however, dealing with this question in more detail, it will be as well at this point to mention the well-established advantages which radio does possess over the cables, and to include the part which the Broadcasting services may be expected to play in any future war.

It will, probably, be generally conceded without argument that radio's chief contribution to the problem of communi-

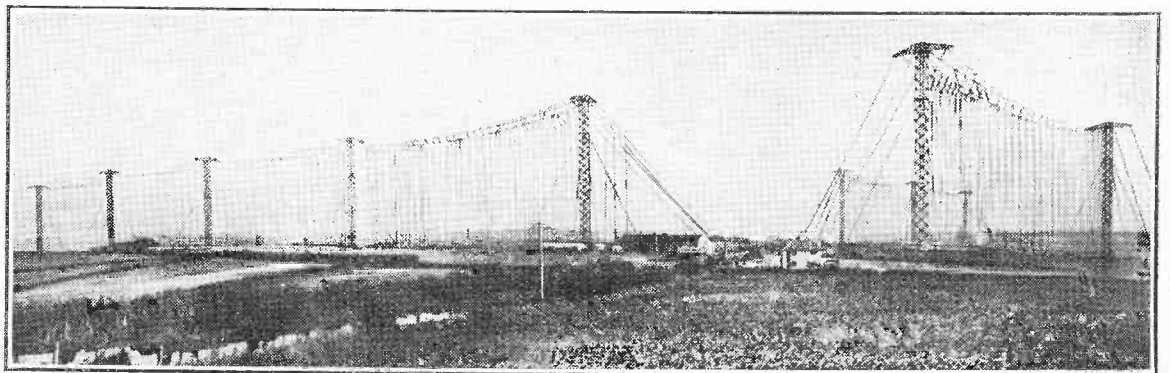

The Beam wireless stations now constitute an important link in the chain of Empire communications. This photograph shows the multiple aerial system at the Dorchester station, operated by Cable and Wireless, which recently established a record by transmitting 1½ million words in a week.

immediately become a serious disadvantage owing to the reduction in the number of cables available, even when allowance is made for modern multiple circuit working. Lastly, owing to certain geo-

graphic factors, many cables are particularly prone to the danger of attack by land. Perhaps the best example of such are the land lines linking the Mediterranean and Far East systems between Alexandria and Suez.

Wireless and Imperial Defence—

had a profound effect upon naval strategy and, in a naturally smaller degree, on its tactics.

The great development of high frequency technique not only ensures that every unit of a fleet is in touch with its base irrespective of distance, but that it is also, if necessary, in direct communication with the Admiralty in London. Similarly, although of course subject to special limitations, aircraft can, by means of radio, communicate with other aircraft or with the ground over distances which were not even contemplated ten years ago.

Closely linked with radio communication between ship and shore is the meteorological service, which, under modern war conditions, is a vital service if the proper use is to be made of defence. It is not generally realised that meteorological forecasting depends for its accuracy

Receivers at the Somerton beam telegraph station (Cable and Wireless, Ltd.).

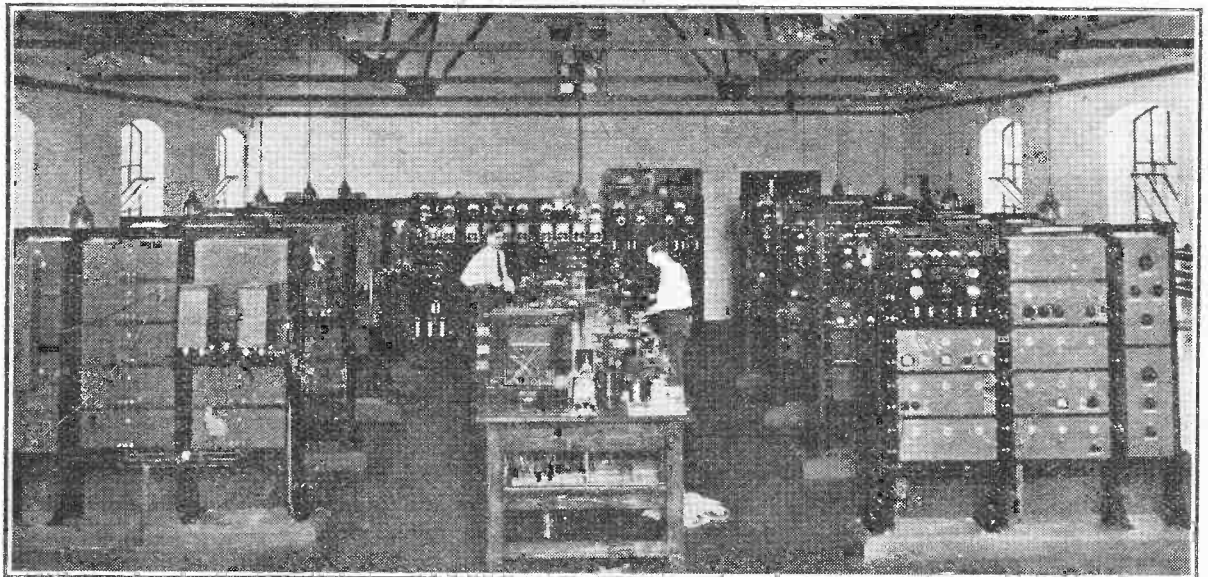

on the examination of reports transmitted by ships at sea as to their local conditions, and radio is, of course, the only means available for the transmission of such reports.

Again, let us, in an admittedly cursory manner, consider the advantages which wireless has to offer in the purely military sphere. The modern army, compared with the forces of only 25 years ago, moves incredibly fast owing to the very high degree of mechanisation which has taken place. Under these conditions radio communication is necessary for tanks, armoured cars, and all the specialised types of motor vehicles which are utilised. An army which moves at high speed, especially when employed in sparsely populated countries, such as in the Near East, must, owing to its speed of movement, have long and rapidly lengthening lines of communication, and where these are effected by wire they are particularly vulnerable to air bombing.

Here wireless comes into its own.

As has been mentioned above, all forms of wireless communication suffer from lack of secrecy, the reasons for which are sufficiently obvious to need no explanation, and, as yet, no method has been developed which will guarantee complete secrecy under all conditions. High-speed teleprinter transmitters certainly ensure reasonable secrecy so far as interception by unauthorised individuals is concerned, but are no protection against reception by an enemy power. Even the most advanced systems of directional transmission

only reduce the area in which interception by an enemy or his agents is possible. Recourse has, therefore, to be made to coding all messages in time of war, but, even though such codes may never be deciphered by the enemy, there is no method of knowing this. The resultant uncertainty entails frequent changes of code, and the more often this is carried out the greater becomes the danger of leakage taking place to the enemy, apart from the vast organisation which frequent and simultaneous changes demand.

the control passes to the British and Dominions Governments.

In conclusion, there is no doubt that in any future war an important part will be played by the British and Empire Broadcasting systems. In addition to supplying the civil population with official news bulletins and warnings of air raids, the Broadcast service offers great scope for propaganda purposes especially to hostile and neutral peoples. Here, strangely enough, the lack of secrecy of Broadcast transmission is its greatest advantage

In order that full advantage might be taken of a joint cable and wireless system for Empire defence, the British and Dominions Governments in 1928 sponsored an amalgamation between the then opposing interests of the Marconi Company and the Eastern Telegraph Company and, as a result, the Imperial and International Communications Company came into being. Besides controlling the Marconi and Eastern Telegraph organisations, the company also control the Pacific Board cables, the Imperial Atlantic cables and the Western Telegraph Union cables. In time of war or of national emergency

because such propaganda cannot be censored, and it may be made in the language of the people whom it is desired to reach. It goes without saying that propaganda broadcasts of this nature would almost certainly be denounced by the enemy countries' own systems, and by their press; nevertheless, the very uncertainty which such propaganda causes among the civilian population has in the long run no little effect on their morale.

Our cover picture is based on a design kindly supplied by the Post Office Film Unit.

Henry Farrad's PROBLEM CORNER

No. 32.—Mysterious Television Shadows

An extract from Henry Farrad's correspondence, published to give readers an opportunity of testing their own powers of deduction:—

"Nouvelle Vue,"
Dulwich.

Dear Mr. Farrad,

I do wish you could come round and see our new television set! It is the envy of the whole neighbourhood, I can assure you. And our aerial is so neat, not like those ugly letter H things some people have, because

it seems we are in such a good position we don't need it. There was great excitement the other day—they were televising the opening of a new building or something at the gasworks at Sydenham. It is only a mile away from here, of course, so we were able to go and see how it was done. That sort of thing is much more interesting when one is a "viewer," I think.

There is just one little thing that seems wrong—I'm sure you could tell us what it is. Whenever anybody comes on the picture there is always a double of him about an inch to the right. Just like a ghost, in fact. Well, I mustn't trouble you any more, but if you can tell what the mysterious shadows are doing there it would be good of you to let us know.

Yours sincerely,
IDA LYTE.

What is a likely cause of this effect, and can it be reduced? Think it out yourself, and then turn to page 137 to see if your solution agrees with Henry Farrad's.

Parasitic Oscillation in Frequency-Changers

By J. A. SARGROVE, N.C.Mech.E., F.T.S., M.Inst.B.E.
(Member of the Tungstram Organisation)

KINETIC-GRID CURRENT IN THE TRIODE-HEPTODE AND TRIODE-HEXODE

FREQUENCY-CHANGING problems have been with us ever since the first attempt was made to produce a beat note by the heterodyne method, but in the early days less obnoxious faults were generally overshadowed by the main problems which are now well understood. Most of these latter have been solved since the older additive method of mixing was given up in favour of the much better multiplicative system, and we are now more concerned with minor effects.

Multiplicative mixing is achieved by using a valve in which the electron stream from cathode to anode is twice subjected to density control. To accomplish this it is essential to produce a so-called virtual cathode, the space-charge of which is subjected to the second control voltage, the first control voltage being applied to the space charge surrounding the real cathode. When considering the means of apply-

CONSIDERABLE trouble from parasitic oscillation is found in short-wave frequency-changers. The remedies have been given in earlier articles in "The Wireless World," but the reason for the trouble has remained obscure. In this article the author explains the mechanism of the effect in detail.

ing density control to an electron stream it must be realised that the electron stream is not completely homogeneous, but consists of electrons moving at different velocities. In other words, the electrons do not proceed as a marching regiment, but resemble more closely the progress of a crowd. Hence, the insertion of a negatively charged grid into the electron stream at first prevents the slower moving electrons from passing through it. As the negative voltage increases, more and more of the faster electrons are barred until finally, when the grid reaches the so-called cut-off bias all electrons are prevented from traversing the grid. All bias voltages above this critical value have no further

effect as regards the anode current (which remains at zero); the grid being in this case an impassable barrier.

However, one is apt to forget that the electrons which are not allowed to pass through the grid to the anode have to go elsewhere, they cannot just stay where they are.

In the case of electrons coming from a real cathode they return to it. In the anode-current cut-off condition, the quantity of electrons in the space-charge surrounding the cathode is in equilibrium, which means that as new electrons are added to the cathode space-charge by thermal emission, the space-charge tends to become more negative with reference to the cathode. This in turn causes those electrons that happen to be nearest to the cathode surface to return to it, due to the repulsive force exerted by the mean space-charge potential. Hence, the space-charge can never increase beyond a certain limit.

The Injector Grid

An analogous effect takes place at the second space-charge or virtual-cathode of a modern multiplicative frequency-changer, and when one is contemplating the control action of the second negative control grid (G₃) on this space-charge, one is even more inclined to forget the fact that those electrons not able to pass through this grid must go somewhere.

As the negative charge of this virtual-cathode cannot be felt by the space-charge surrounding the real cathode, due to the fact that the first positive accelerator grid (G₂) lies in between, it is obvious that the increasingly negative potential of this space-charge must cause electrons to fall towards the above-mentioned positive accelerator electrode and, being absorbed by it, appear in the external circuit as the so-called screen current.

Knowing this, we can now examine in detail what takes place as the second control, or injector, grid (G₃) oscillates from approximately zero bias to a value more or less equal to the cut-off voltage.

In Fig. 1 we have a diagrammatic representation of the heptode portion of a triode-heptode frequency-changer showing the normal position of the space-charges. Alongside it is the corresponding time-distance diagram of the probable course of the electrons after leaving the cathode,

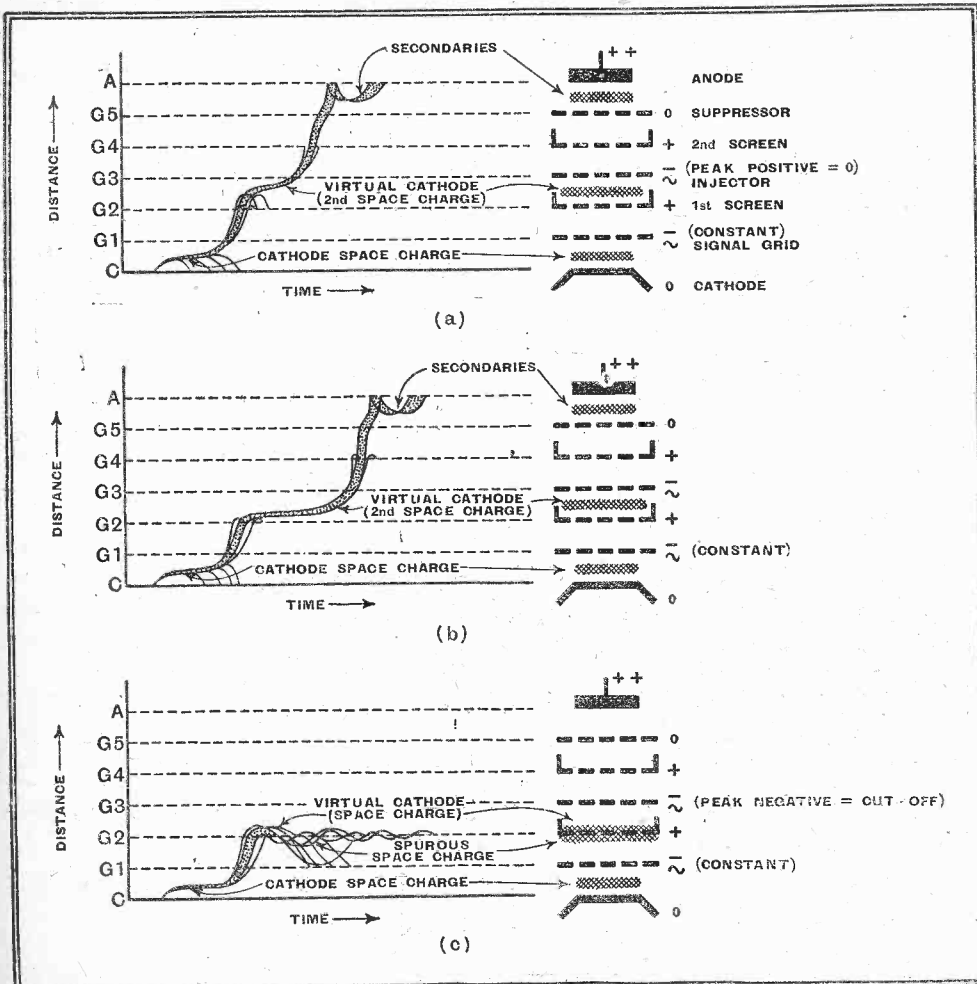

Fig. 1.—These rather unusual time-distance diagrams show the behaviour of the electron stream inside the heptode mixer path of a triode-heptode valve. (a), (b) and (c), correspond to the cardinal operating points of the heterodyne injector-grid voltage wave, shown in the lower half of Fig. 2.

Parasitic Oscillation in Frequency-Changers— assuming the electrodes to have normal operating voltages and the injector grid to

second. accelerator (G4). Another slight slowing down occurs before the suppressor grid (G5) which has a very open grid

away from the injector-grid or the second control-grid (G3), owing to its considerable negative voltage at this instant.

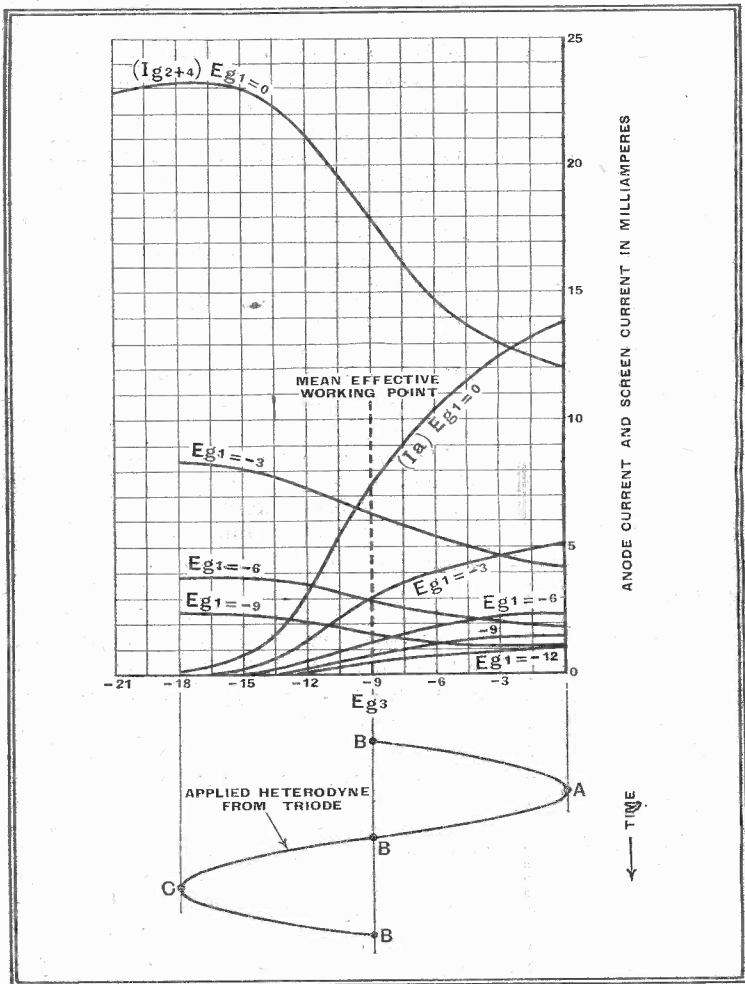

Fig. 2.—Static anode current and accelerator grid current curves of a typical triode-heptode taken as a function of the injector-grid voltage. The bottom half of the figure shows the heterodyne wave in a time-distance sense. The three cardinal points are (A) maximum positive peak; (B) mean effective voltage; and (C) maximum negative peak.

be at approximately zero potential, i.e., at the peak of its positive excursion (point A, Fig. 2).

After emerging from the cathode with their spontaneous initial velocity the electrons dwell for a while near the cathode. This is because the attraction of the positive accelerator (G2) through the interstices of the first control-grid (G1) is not active to any great degree, and the large number of negative electrons that have just left the cathode exert a large negative counter-balancing influence, and here form the cathode space-charge (or first space-charge). Their outward velocity, however, gradually increases under the influence of the first accelerator (G2) and reaches a maximum as they pass through the interstices of this grid. As soon as they emerge here they get retarded (or decelerated) by the injector-grid which is at an instantaneous zero bias, and by the attraction of G2 which, being positive, tries to pull them back. They are only feebly attracted by G4, the second accelerator, which is still some way off.

After they pass through the injector-grid their speed is soon increased again, and achieves a second maximum just as they pass through the meshes of the

form the G2 and G4 currents (a pure loss). As this current is comparatively small, it is represented as a thin line in this picture.

If we now carry out the same examination for other

Fig. 3.—Typical measuring circuit used to obtain the static signal-grid-volts—grid-current curve of a triode-heptode.

points of the voltage wave on the injector-grid shown in Fig. 2 we get for point B, the mid-point in the oscillator excursions, a different set of time distance paths. Not only is the time of transit between G2 and G3 longer, but the number of electrons that flow to the first accelerator is much greater. Hence, the anode current is smaller.

This curve also has a lower slope (hence multiplicative mixing) which is due to the fact that the virtual-cathode or second space-charge is compressed, and is farther

Some of the slowly moving electrons are absorbed by G2, but some must pass through the grid meshes, back into the space between G1 and G2, whence they are pulled back by the positive attraction of G2 to be finally absorbed by G2 after performing an indefinite number of oscillations back and forth between G2 and G3 space and G2 and G1 space. The pulsance of these spurious oscillations is very high, and the total duration of the latter is probably commensurate with the total electron transit time, and they do not appear to have any influence on the resultant action of the mixer valve as a whole,¹ except at ultra high frequencies. The impedance of all electrodes should be very low to such very high frequencies, due to the appreciable mutual grid capacitances; though it is feasible that the long lead wires between the electrodes and through the external earth to the cathode may have inductance sufficient to make some of them resonant.

An important and quite convincing test is available to prove that electrons do, in fact, return from the normal virtual-cathode (second space-charge) to the neighbourhood of the first control grid

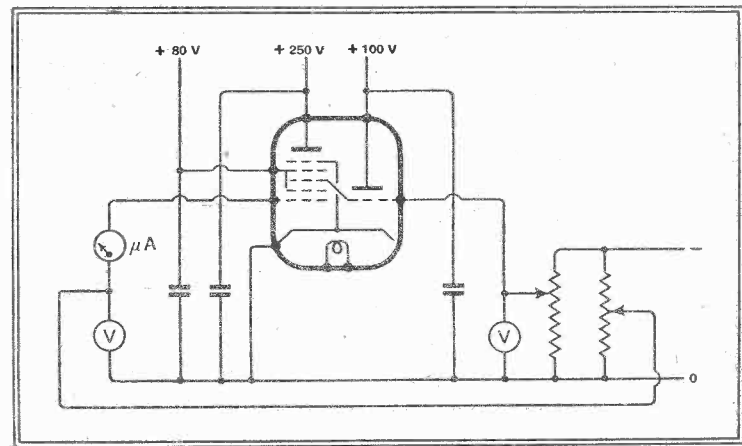

and this can be performed as follows:— Let us arrange a mixer valve as in Fig. 3 applying normal operating voltages so that we can take its static signal-grid-voltage—grid-current curve (as shown in the top half of Fig. 4).

It will be seen that the particular valve measured, Tungram Type TH29, ceases to pass grid current at point $I_{g1}=0$ which occurs in this specimen at a bias of -1.0 volt. We now slightly modify our test

and this can be performed as follows:— Let us arrange a mixer valve as in Fig. 3 applying normal operating voltages so that we can take its static signal-grid-voltage—grid-current curve (as shown in the top half of Fig. 4).

It will be seen that the particular valve measured, Tungram Type TH29, ceases to pass grid current at point $I_{g1}=0$ which occurs in this specimen at a bias of -1.0 volt. We now slightly modify our test

¹ The Wireless World, 7th and 14th May, 1939.

Parasitic Oscillation in Frequency-Changers—circuit, see Fig. 5, by coupling a powerful signal generator² to the oscillation injector-grid (G3) and insert decoupling means into each electrode to ensure stable conditions for measurements at very high frequencies. We find that with a given oscillation on the injector-grid, G3, current now flows with the signal grid biased to the point where previously no grid current existed, i.e., that by shifting the bias (E_{G1}) potentiometer towards the negative we get a series of new positions for $I_{G1}=0$. From Fig. 5 we see that the value of E_{G1} for $I_{G1}=0$ increases exponentially with the frequency and the amplitude of the oscillation on the injector-grid.

This test proves not only that electrons return from G2 and G3 into the $G1-G2$ space, but it also shows that some of the electrons have sufficient kinetic energy to hit $G1$. The electrons reaching $G1$ in this reverse direction produce the above measured signal-grid current which one can conveniently term "kinetic signal-grid current," though it has been termed "transit-time current" by

others³ due to the fact that its value increases rapidly as the period of oscillation on the injector-grid approaches the transit time of electrons entering and leaving $G2-G3$ space.

It would appear that the explanation of the parasitic pseudo-signals described by W. T. Cocking⁴ and by A. Owen Walker⁵ lies in the fact that at point C in the injector-grid voltage wave, electrons have penetrated $G2$ in a reverse direction, building up a new space-charge and causing grid current. This extra unintentional spurious space-charge causes by influence and/or electronic bombardment, shock excitation of the tuned circuit attached to the signal grid. To clarify this further, it should be remembered that this spurious space-charge is not always present throughout the heterodyne oscillator cycle, but is a discontinuous phenomenon occurring only at the negative peaks of its voltage excursions. This fact was already recognised by A. Owen Walker though his explanation at the time was different.

On short waves (in a conventional superheterodyne where the intermediate frequency is very small compared with the input frequencies), these periodic space-charge penetrations will occur at a fre-

quency very similar to the resonance-frequency of the signal-grid ($G1$) circuit and shock excitation is readily achieved.

Fig. 4.—The top half of the diagram shows the static signal-grid-volts—grid-current curve with a cut-off potential at point $I_{G1}=0$; the lower half shows the displacement of this cut-off point as a result of the heterodyne oscillation of increasing frequency and magnitude impressed on the injector grid (E_{G3} eff.)

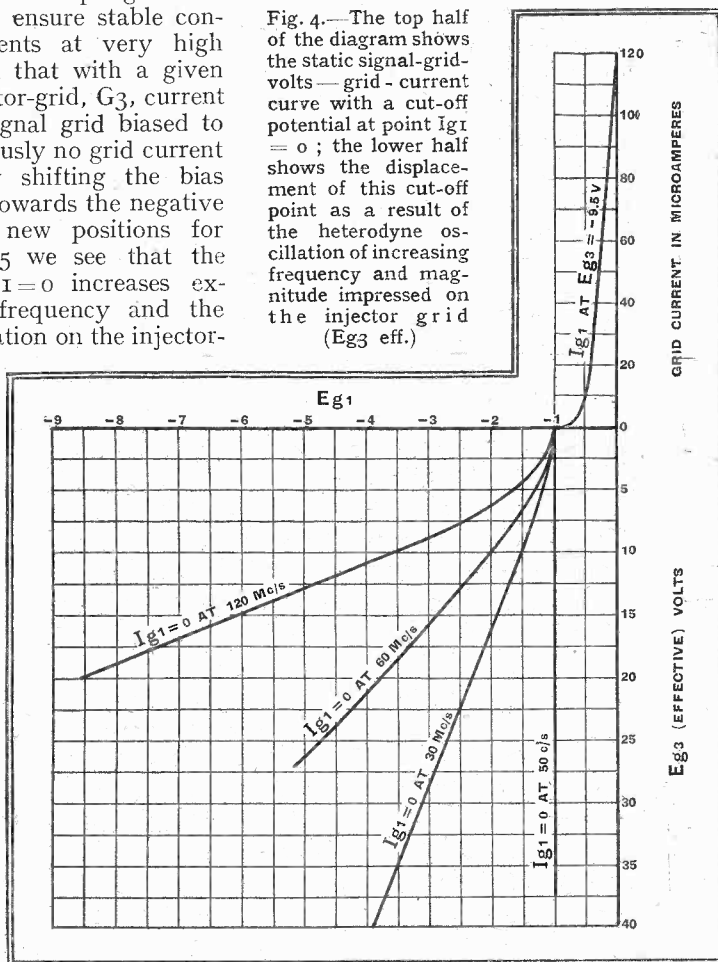

quency would not occur to a similar degree on medium and long waves, where the resonance frequencies of the tuned circuits are very different. The fact that the instant the impulse takes place the heptode mixer section of the valve is cut off does not alter matters, for it is clear that the excited input circuit will oscillate at least one complete cycle and probably many more, depending upon its degree of damping.

Another fact that seems to show that this explanation is the correct one is that one

can mitigate the trouble by inserting resistance into the signal-grid lead, i.e., by increasing the damping, and thus reducing the impedance, of the resonant circuit reflected into the valve. Moreover, reducing the heterodyne voltage or taking the alternative lower oscillator frequency will obviously be a partial remedy (as is done in many commercial receivers). A further remedy less frequently employed is to apply a larger initial bias than usual to the signal-grid on ultra-short and short waves. It has been suggested^{1,5} that there is perhaps a simpler explanation based on a negative resistance characteristic in the mixer valve. For a negative resistance characteristic to produce the parasitic pseudo signals, however, it must excite one of the tuned circuits associated with the mixer valve, i.e., it must excite either one of the two input circuits or the output circuit. As the heterodyne oscillator is already exciting the injector-grid circuit, we have only to consider the signal-grid circuit and the IF anode circuit. In the static signal-grid-volts-grid-current curve, as shown in the top half of Fig. 5, there is no negative resistance kink, nor is there such a portion due to kinetic grid current in the dynamic curves shown in the bottom half of Fig. 5.

Negative Resistance

Let us now examine the anode circuit from an analogous viewpoint.

In the first place a negative resistance kink only occurs in the characteristic of the triode-hexode, and is eliminated in the triode-heptode by the suppressor grid. Nevertheless, both types are equally prone to the generation of the parasitic pseudo signals, and the trouble in both can be cured¹ by the same means, viz., by reducing the amplitude of the heterodyne oscillations and by inserting resistance into the signal-grid circuit.

Even with the triode-hexode the usual operating region is at anode voltages well above this negative resistance kink, which consequently plays no part. There is one more possibility, however, and this is that the combined currents of the screen or

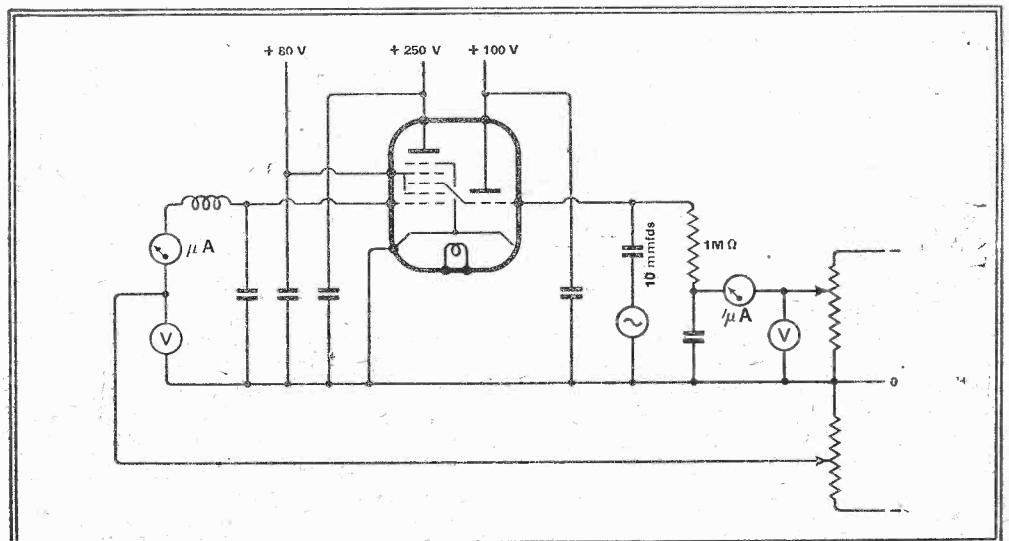

Fig. 5.—Measuring circuit to obtain $I_{G1}=0$ displacement curves as a result of very high frequencies impressed on $G3$ by a powerful signal generator.

² Television and Short Wave World, March, 1939—pp. 181-182.

³ Philips Set-Makers Bulletin, Oct., 1937, pp. 40-41 (EH2).

⁴ The Wireless World, Feb. 9th, 1939.

⁵ The Wireless Engineer, August, 1937.

New Apparatus Reviewed

GRAMPIAN 50-WATT AMPLIFIER

THERE are four stages in this amplifier, the first two being H63 triodes, the third a KTZ63, and the output stage, four 6L6's in class AB parallel push-pull. There



Grampian Type 385 amplifier.

are three input circuits, two for microphones (20 ohms) and one for a gramophone pick-up, each circuit being provided with its own volume control and mixing circuit.

Separate bass and treble time controls are provided by suitable variable filters between the first and second valves. The curves we have taken show that these do really work as they should without mutual interaction, and without appreciable effect on the middle register.

The input-output curve shows little deviation from linearity even above the rated output, and on the oscillograph there is no visible distortion at 50 watts output.

It is difficult to ascertain the "normal"

Output impedances of 600, 15 and 6 ohms are provided, and the power consumption is 155 watts. The price, complete with valves, is £40.

This is a conservatively rated instrument which can be relied upon to perform in every respect according to the maker's specification.

"DENCO" SHORT-WAVE COMPONENTS

LOSSES in ultra-short-wave transmitting equipment are largely bound up with the type of insulation employed to support coils, RF chokes, etc. Many transparent materials of the "organic glass" variety are available for this purpose, but the only type which is really satisfactory at very high frequencies is polystyrene, known under various trade names such as "Distrene" and "Trolitul."

The components made by Denco use polystyrene throughout and the material is also sold to amateurs in the form of rod, tube and sheet. With the right kind of solvent it makes a useful cement or "dope" for coils, as its electrical properties are not seriously affected after the solvent has dried out.

Prices are reasonable and a short-wave choke (4-100 metres) costs 2s. Stand-off insulators cost 6d. or 8d. and coils wound to any range in ribbed formers are priced

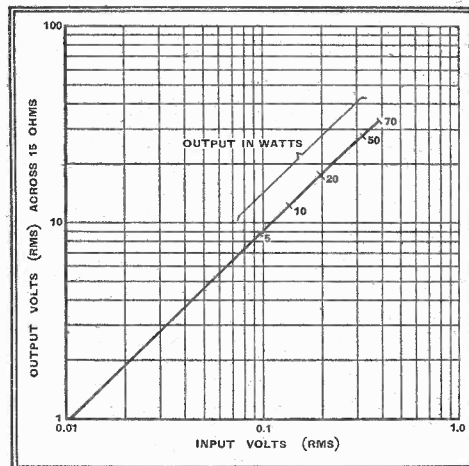

Input-output curve of the Grampian 50-watt amplifier taken on the pick-up input terminals. With direct connection to the grid of the first stage, full output is given for an input of 0.001 volt.

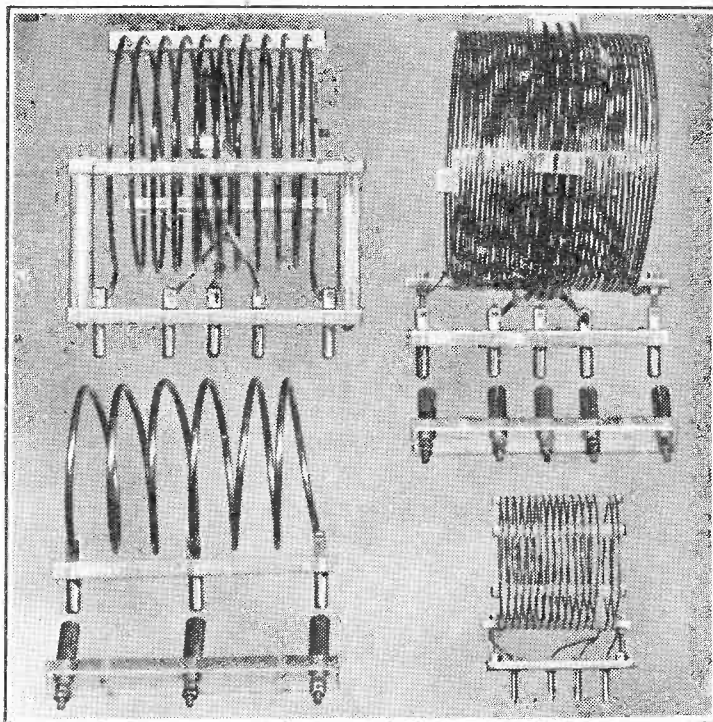

Plug-in type low-loss Denco coils.

at 3s. or 4s., with 4-pin base. Special "air spaced" coils with the minimum of insulation cost from 4s. 6d. to 6s.

The new address of the makers is Denco, Warwick Road, Clacton, Essex.

Samples of polystyrene insulation and "Denfix" quick-drying solution.

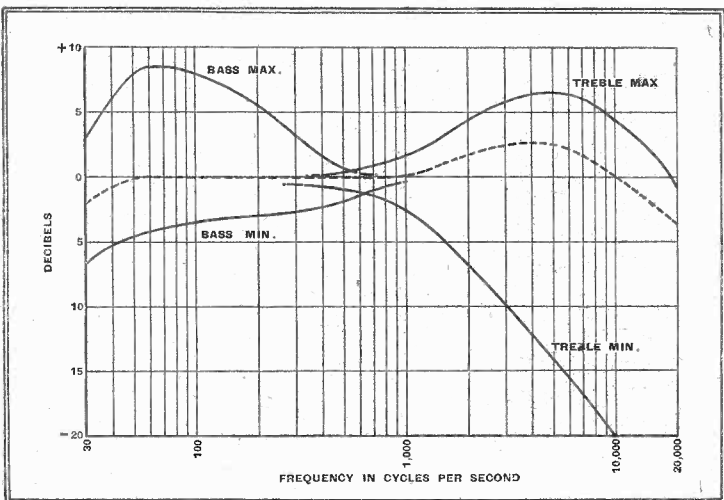

Frequency response of Grampian Type 385 amplifier. The dotted curve is for an arbitrary setting of the tone controls near their mid-positions.

frequency response as the time controls are always in circuit, but the response at an arbitrary setting near the mid-position of each control gave the dotted curve which is level within 2 or 3 db between 30 and 20,000 c/s.

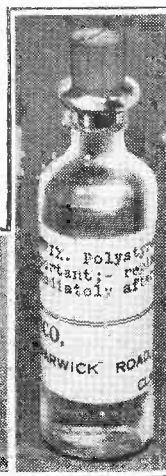
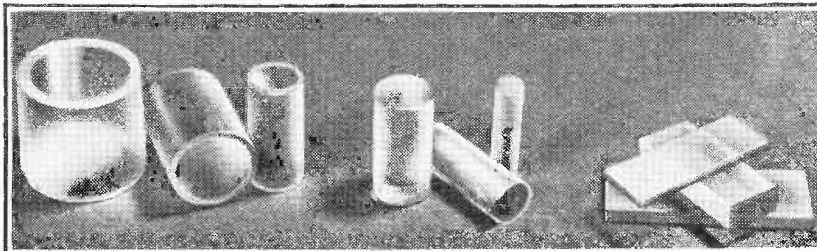

UNBIASED

Ground Speed Indicator

New Readers Start Here:

Free Grid has had submitted to him an idea for a ground speed indicator for aircraft. The invention is based on wireless principles, and arose from the fact that the inventor, a keen amateur airman, noticed that fading occurred when receiving broadcast programmes, the degree of fading varying with the speed of his aircraft. He found by experiment, that the fading was due to automatic detuning of the receiver, caused by the movement of the aircraft, the degree of detuning, and therefore the fading, fluctuating in sympathy with the speed of the aircraft over the ground. The explanation of the phenomenon is given below. Now read on.

LIKE all really great inventions, it depends upon a very simple fact. When a station is transmitting and its signals are being picked up by a stationary receiving aerial in the ordinary way, there are a certain number of waves passing the receiving aerial every second, the number depending solely upon the wavelength being used. Let us suppose that the aerial was mounted on a Wellsian aircraft, travelling *away* from the broadcasting station at half the speed of wireless waves; it is then obvious that the number of waves passing the receiving aerial in one second would be only half what it was when the aerial was stationary. The effect would be exactly the same as if the transmitting station had halved its frequency, and we could only pick up its signals if we retuned our receiver to the *apparent* new wavelength. If we were flying *towards* the broadcasting station, the effect would be the same as if the transmitting station had *doubled* its frequency instead of halved it, and we should have to retune



Cheques to be made payable to me.

our receiver the other way. In other words, the effect produced by the movement of the aircraft is *apparently* to detune the receiver, the degree of detuning depending upon the speed at which the aircraft is approaching or leaving the transmitting station. Only when the aircraft comes to rest are things normal. The same phenomenon would hold good in the case of a car and explains the reason why certain speeding road hogs complain of fading of the B.B.C.'s programmes. I trust that this is all clear, and that financial support will be forthcoming from you in due course for the Radio Ground Speed

Indicator Company. Pending the registration of the company, all cheques can be made payable to me.

The Faithful Hound

I WAS very astonished to read a little while ago of the remarkable success that has attended certain experiments conducted in the famous Pasteur Institute to counteract the evil effects of snake bite by means of short waves. It appears that if the bite is irradiated as quickly as possible by the emanations of a 20-metre transmitter, astonishing effects occur. At first, the virulence of the poison is increased, but if the treatment is continued long enough the poison is neutralised. The great thing that struck me about it was the relatively long wavelength used, as therapeutic wireless measures, like diathermy and bloodless surgery, generally call for a wavelength well down amongst the ultra shorts.

However, I should probably have dismissed the matter from my mind had I not, by some ill-chance, left my private papers lying about where Mrs. Free Grid could see them. Apparently, among other things, she must have read the information I had received about the radio snake bite cure. At any rate, as ill luck would have it, she threw a party a few days later and an incident occurred, which has resulted in a possibility of the whole matter being ventilated in the local police court, with myself as the central figure.

On the afternoon of the party I locked myself in my private wireless den as I have had previous experience of the type of female who come to make free with my bread and margarine on these occasions. Unfortunately, I did not take my dog with me, and therein lay the cause of all the subsequent trouble. The dog is particularly devoted to me, and, as those of you who have not forgotten your Iliad will remember, dogs have a very high sense of duty. At any rate, the dog considered that the collection of females whom Mrs. Free Grid saw fit to entertain, was not of the type which would appeal to me, and rightly or wrongly concluded that it was his duty to deputise for me, and promptly bit one of them.

Needless to say, I was summoned from my den to render first-aid. During my younger days I spent some time sailing before the mast in a whaler, a type of ship where accidents are frequent and the first-aid effective, but rather crude, and when I put the poker in the fire as a preliminary to a little job of cauterisation, strong protests were raised, and it was then that the recollection came to Mrs. Free Grid of what she had read in my private papers about treating snake bites with short waves.

By FREE GRID

In vain I endeavoured to point out to her the essential difference between dogs and snakes in the matter of their bites. It was all to no avail, and eventually the patient was removed to my den and placed near the aerial terminal of my transmitter. It has often been said that high frequency doesn't hurt, and whether the theory was disproved that afternoon, or whether I accidentally coupled the patient up to the HT supply I cannot rightly say, but, in any case, the ensuing



A multitude of charges.

yells she set up brought a passing policeman on the scene in double quick time.

I am now faced with a multitude of police court charges, including the establishing of an electric treatment centre without a licence, unlawful use of my wireless transmitting apparatus, intent to inflict grievous bodily harm, and lastly, keeping a ferocious dog without exercising proper control over it.

Neon Signs

AS I was passing the Scotsman's cinema in Piccadilly Circus late one night last week, I paused to wonder how many of the flashing neon signs were fitted with suppressors for the benefit of listeners in the neighbourhood. In order to answer my own mental question I slipped into the driving seat of a car that was standing at the kerb and switched on the radio set with which it was fitted. I must confess that I was extremely surprised at the almost complete absence of electrical interference. I can hardly believe, even now, that neon sign owners can have been so heedful of listeners' comfort as my tests seemed to indicate, and I should have continued my experiments had it not been for the overbearing attitude of an officious police constable who, mistaking me for a vulgar drunk and disorderly, thrust his head into the car with an uncouth "Come on aht of it."

NEWS OF THE WEEK

RADIOLYMPIA'S MODEL FACTORY

Receiver Design and Construction

ONE of the major attractions, at least so far as the technically minded visitor is concerned, at this year's radio show, which opens at Olympia on August 23rd, will be the model factory. This innovation will include various aspects in the design and manufacture of receivers.

Although complete details are not yet available we understand that the exhibits will include coil and resistance winding, RF coil adjusting, loud speaker re-

sonance testing, impedance and inductance comparisons, ganged condenser testing, tubular condenser construction, chassis wiring, testing and assembly. Some features of valve and dry-battery construction will also be depicted.

Each of the above processes will be demonstrated by individual manufacturers who will endeavour to show by their joint efforts the various stages in the production of a modern receiver.

BROADCASTING IN FRANCE

Radio and Television Licences: National Broadcasting Administration

IT is learned from the official organ of the Postal Worker's Union that the projected French Financial Law provides for an increase in the wireless receiving licence fee from January 1st next and the introduction of an additional fee for television receivers.

According to the present proposal, owners of valve sets for domestic use will pay 70 francs instead of 50 francs. Receivers in public places and traders' shops used for free entertainment will be rated at 140 francs, whilst a fee of 280 francs is proposed in the case of sets in halls charging for admission.

The proposed television tax on receivers for private use is 140 francs. Double this fee will have to be paid by owners using sets for free entertainment or demonstration purposes plus an additional 140 francs for each additional viewing screen. Where televisors are used in halls charging for admission, the tax will be 560 francs plus 280

francs for each additional screen.

It is stressed that the income from the additional taxation of receivers would be used exclusively for the broadcasting service.

The B.B.C.'s Counterpart

A decree approved by the French Cabinet last week provides for the creation of a National broadcasting organisation which will be similar to the British Broadcasting Corporation except that it will be under the direct control of the Prime Minister. It will be known as the Administration of National Broadcasting and will provide National and Regional programmes from two groups of stations.

One group will comprise Paris PTT, Toulouse, Strasbourg, Limoges, Montpellier, Grenoble and Nice; the second group including Radio Paris, Eiffel Tower, Lyons, Marseilles, Lille, Bordeaux and Rennes.

GERMAN TELEVISION

Some "Private" Developments

ALTHOUGH the Standard Television Receiver was the only one to be seen at the Berlin Radio Exhibition, which closed last Sunday, some of the manufacturers are continuing the development of their larger models for marketing when permitted.

Among these manufacturers is the Fernseh Company which has developed a televisor incorporating a flat-ended cathode-ray tube giving a picture 31.5 by 27.5 cm. The tube is unique in that it is only 42 cm. long and therefore does not unduly increase the depth of this table model receiver. The set incorporates an all-wave superhet,

which is adapted for the reception of the wired wireless system.

The intermediate frequency in the vision receiver is 4.2 Mc/5.

The Fernseh Company is also producing a television adaptor which can be used with a Blue Spot six-valve superhet.

A small projection type receiver for home use is another of the Company's products in which a new projection cathode-ray tube and a new type of lens-screen reflector are used. The resultant picture, which is 42 by 50 cm., can be viewed in comfort from as close as two yards.

RADIO ON HIGH-SPEED BOATS

British Equipment for Belgium

TWO motor boats similar to those used as tenders by the R.A.F. have been ordered from the British Power Boat Company for the Belgian Air Ministry. The boats, which have a top speed of 27 knots, will be equipped with Power-Gambrell wireless telephony and telegraphy apparatus specially designed for high-speed craft.

The equipment is designed for telephony transmissions on 100-200 metres and CW and ICW on 100-200 and 500-600 metres. It is constructed for either 12 or 24 volts direct current and can be run, therefore, from the ship's batteries. The total consumption during transmission, when running from a 24-volt battery, is approximately 14 amperes.

The carrier power in the aerial is approximately 40 watts and modulation up to 100 per cent. is readily obtainable.

The four pre-determined spot frequencies can be modified to give any desired wavelengths between 100 and 200 metres. For this purpose a wave meter is supplied for checking.

The working range is, of course, dependent on the type of aerial used, but with a normal outside aerial distances up to 100 miles telephony and 200 miles ICW have been achieved under normal seagoing conditions.

The complementary receiver, which derives its HT from a vibrator, covers the 100-200-, 500-1,000- and 1,000-2,000-metre bands. There are two positions for the 'phone jack, one providing 'phone reception with the loud speaker working and the other 'phone reception only.

The total weight of the equipment, each unit of which is in a casting of salt-water-resisting aluminium alloy, is 170lb.

CANADA'S ELECTION CAMPAIGN

Free National Network Broadcasts

WITH a Dominion election a possibility this autumn, the Canadian Broadcasting Corporation's board of governors at its meeting in Ottawa in July, formulated plans to give a free National radio network service to all political parties from Government-owned as well as privately-owned broadcasting stations during the election period. Commercial stations will give the political broadcasts as free programmes, "as a measure of public service in consideration, in part, of the privilege of operating on a public franchise."

The C.B.C. will allot time to all parties, the allocation being

AT THE OPENING of the German Radio Exhibition by Dr. Goebbels, the Minister of Propaganda, on July 28th. Telefunken's new television camera, which is supplied to the Post Office who operate the television apparatus, can be seen on the right. In his opening address, Dr. Goebbels said "Broadcasting has to stand on guard against lies and vilification, and with the Press, is the sharpest spiritual weapon in the Nation's struggle for existence."



News of the Week—

based on the party's representation in Parliament at the time of its dissolution, the number of candidates in the last two elections, the total vote cast for each party in the last two elections and the standing of the parties at the election prior to the last.

There will be no political broadcasts from any station

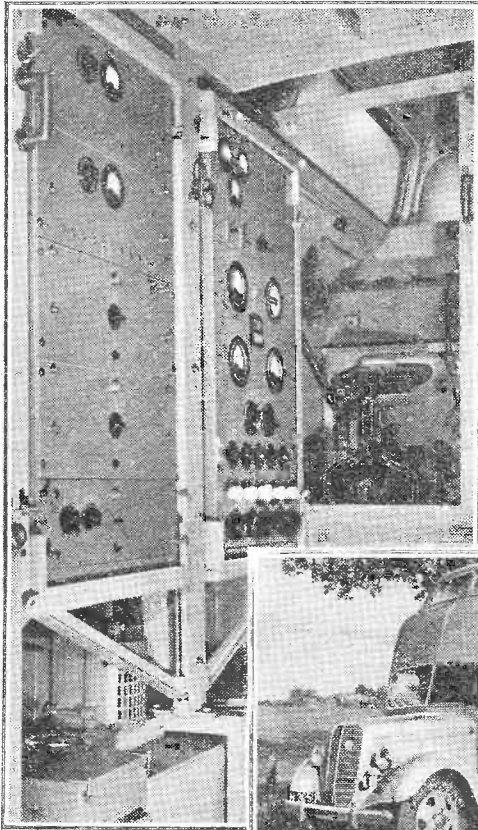

NORWAY'S RECORDING VAN incorporates a reporter's glass conning tower the interior of which can be seen above.

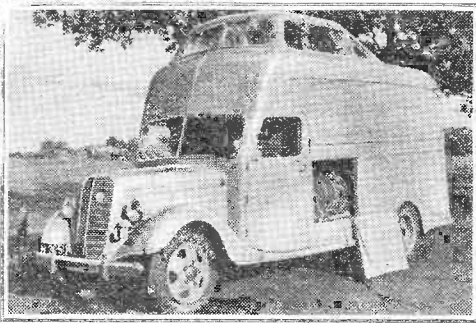

within forty-eight hours of the opening of the polling booths, and the last broadcast of the campaign will be made by the Government party at the time of the dissolution of Parliament.

If the scheme, which is designed to give more orderly broadcasting campaigns to an election, is successful it will be used for provincial elections.

RADIO-CONTROLLED AIRCRAFT

MANY more radio-controlled aircraft (Queen Bees) are available for practice shooting at the Anti-Aircraft camps this year. Whilst this is a good thing, in that they give a better idea of the behaviour of hostile aircraft than any other form of target, the main objection to them is their speed which is about 80 miles per hour—about half the minimum speed of a modern bomber.

The Queen Wasp, a much faster plane, which has been promised for some time, is soon to be available for the Fleet Air Arm, but the Army will, so far as is known, have none this year.

A STUDIO ON WHEELS**Features of a Recording Unit**

FOLLOWING an order from the Norwegian Broadcasting Company, Norsk Rikskringkasting, the Philips Company of Eindhoven has adapted its well-known Philips-Miller film recording system to the requirements of a mobile radio reporter unit. A car weighing 5 tons, complete with full equipment, and fitted with an 85 h.p. engine, has been equipped with recording apparatus.

The advantages of the Philips-Miller system for mobile work lie in the fact that it does not need to be kept horizontal, and that it operates just as efficiently when

where possible, must necessarily include a certain amount of hard wood in its construction so that the high frequencies are not cut off. A further acoustic treatment of the cabin is that each sheet of glass is of a different thickness and is fitted at a different angle to the remainder.

**FROM ALL
QUARTERS****Rome Television Reception**

MR. F. T. BENNETT, a radio engineer of St. Peter Port, Guernsey, reports the reception of the Rome television transmission. Although over 900 miles from the transmitter at Monte Mario, he saw clearly the letters E.I.A.R. on the announcement board. We published in our issue of March 30th this year a photograph of Mr. Bennett's aerial with which he regularly receives the B.B.C. television transmissions.

"It is More Blessed to Give . . ."

To encourage Swiss listeners to dispense with their old receivers and to buy new ones, a philanthropic scheme is being tried. Listeners giving their old sets to recognised benevolent organisations are given a coupon which entitles the holder to a fifteen per cent. reduction on the purchase price of a new receiver.

Another South African Short-Wave Station

THE Marconi Company has received an order from the South African Broadcasting Corporation for the supply of a 5-kW short-wave broadcasting transmitter. It is believed that this 13.5 to 100-metre transmitter is to be erected at Maraisberg, Transvaal. The order also includes monitoring and speech equipment and a concentric feeder with special arrangement for switching to various aeriels.

Totalitarian

ALL religious Sunday morning broadcasts from the German stations have been discontinued. In place of these the Hitler Youth provides "Ceremonial Hours" for all Regional transmitters, whilst the Deutschlandsender broadcasts a regular "spiritual uplift" programme. All the German stations have in the past broadcast some form of religious programme on Sunday mornings.

Maison de la Radio

M. JULES JULIEN, the French Minister of Posts, Telegraphs and Telephones, who controls the State broadcasting stations, is taking steps to improve the existing studio accommodation of the four stations operating in Paris. These studios, it is expected will be abandoned when the long-awaited broadcasting house materialises. 80,000,000 francs have for a very long time been ear-marked for this work, but a worthy site has not yet been found.

New C.B.C. Station

SPEAKING from London, Mr. Ogilvie, Director-General of the B.B.C., and Mr. L. W. Brockington, Chairman of the Canadian Broadcasting Corporation, who is on a visit to this country, took part in the opening ceremony of the C.B.C.'s 50-kW prairie station in Saskatchewan. This is the fourth of the contemplated chain of high-power stations across the Dominion. It is situated at Watrous, near Saskatoon, and will use the call sign CBK.

"Hall-Marked" Receivers

THE French organisation S.P.I.R. (Syndicat Professionnel des Industries Radioélectriques) has announced a scheme whereby receivers meeting a required standard of efficiency in selectivity, sensitivity, power and tonal quality will have a "quality-security" mark.

Dismasted

HAVING served the Bournemouth area for over fifteen years, the B.B.C. station, which in the early days was known as 6BM, is being dismantled and the last section of the steel masts was removed a few days ago.

Indian Listeners

A MARKED increase in the number of receiving licences in force in India is shown in the latest returns. The number of licences in British India at the end of May was 75,524, which is an increase of over 21,000 during the year.

Germany's "Radio Prize"

THE prize of Rm.10,000, which is given annually in connection with the Berlin Radio Exhibition, has this year been awarded to Oberingenieur Griesing. He was foremost among the designers of the original Volksempfänger and is largely responsible for the improvements in the new models.

Hollywood Honoured

THE Columbia Broadcasting System's Hollywood studio headquarters, which were opened early this year, has been chosen as the outstanding example of modern architecture by the Southern California Chapter of the American Institute of Architects.

Australian Radio Journal

ALTHOUGH the constitution of the Australian Broadcasting Commission empowers it to issue publications, its recent proposal to publish a weekly radio magazine has met with much criticism from Members of Parliament, the Press, and the public.

Voigt Corner Horn

IN connection with the review of the Voigt bass chamber for the H.C. horn in last week's issue, it should be pointed out that this is a patented article and the price of the blue print which is available to owners of Voigt speakers includes the royalty due.

"Danger—High Voltage!"

THE horizontal scale of Fig. 8 on page 101 of last week's issue should have been marked kilovolts and not kilowatts.

High-voltage Problems—II

INSULATING MATERIALS AND THEIR PROPERTIES

By L. HARTSHORN, D.Sc.

THE breakdown of insulating materials under high voltages is a phenomenon of such importance in all branches of the electrical industry that a vast amount of research on the subject has been carried out in recent years. Broadly speaking, there are two ways of tackling the general problem of the prevention of breakdown. The first is to make the most of existing materials by more and more attention to the details of design and testing. The second is to search for new materials with better characteristics. In this article it is proposed to consider the results of this second line of attack, that is, to consider how far the problem may be controlled by the nature of the insulating materials.

It must be confessed that at first sight the record is not very impressive. We cannot, for example, point to new materials with values of electric strength vastly greater than those of the old ones. We are tempted to conclude that the triumphs of modern high-voltage engineering are those of the electrical designer rather than those of the chemist. Nevertheless, performance is not governed by electric strength alone, but by combinations of many properties, and the significance of the various materials can only be understood by a consideration of the several factors involved.

Electrical Strain

Consider first the notion of electric strength in its simplest form. Whenever an insulating material lies in an electric field, it is subjected to an electric force which is equal to the voltage gradient. This force produces a displacement of all the positive and negative charges which go to build up the atoms and molecules of the material, the positive charges being pushed in one direction and the negative charges pulled in the other, so that the material is thrown into a state of strain. As the potential gradient increases the strain increases, until at a certain critical value the structure collapses, in much the same way as it would under excessive mechanical stress. Adopting this simple idea, the critical voltage gradient is a measure of the electrical strength of the material, and it is measured by the obvious method of putting a plate of the material between two metal electrodes calculated to produce a uniform electric field, throughout the small region where the field is strongest, and observing the voltage gradient at which breakdown occurs.

If this test is applied in a straightforward manner, imitating as far as possible the conditions under which materials are used in ordinary practice, the results are apt to be very erratic. Nevertheless, if a ver-

ages are taken there is a certain general consistency, which shows that the values do represent in a rather vague way the tendency of the material to resist breakdown.

Selecting published values which seem to be representative, we find that ebonite has the highest electric strength of all ordinary materials, the value for pure ebonite often being as high as 150 kilovolts per mm. That is to say, one of the oldest materials is still the strongest electrically. The laminated boards of synthetic resin and paper, e.g. Bakelite boards, which have so largely replaced ebonite for most purposes, usually give a value of about 30 kV/mm. and about the same value is usually quoted for the clear transparent hydrocarbon resins which have such extraordinarily low power factors (Distrene, Trolitul). Ceramic materials of the steatite class usually give values of 40 or 50 kV/mm. and a similar value is obtained for mica. Values of 20 kV/mm. are quoted

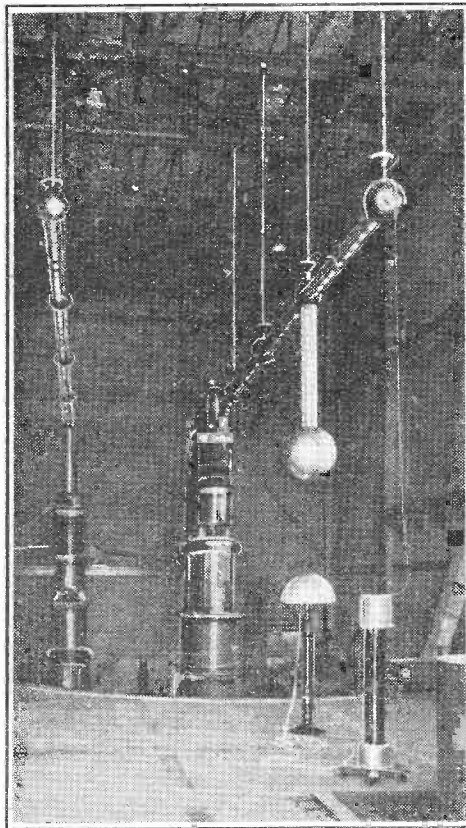

(Crown copyright reserved)

The high-voltage room at the National Physical Laboratory. Insulators for the million-volt transformer are some 20 ft. high and are made of synthetic resin-paper.

for fused quartz and also for paraffin wax. It is clear from these values that ebonite stands out as an excellent general-purpose high-voltage material, but that between the

THE introductory article of this series dealt with the general nature of effects and phenomena encountered at voltages of the order to be found in television receivers and amateur transmitters. The suitability of insulating materials of various types for use in high-voltage circuits is now discussed.

other materials there is surprisingly little difference in electric strength.

It should be stated here that the simple notion of breakdown mentioned in connection with the above values, although convenient as a working idea for practical purposes, will not bear close examination. Materials can, under suitable conditions, be made to stand far higher gradients than those given. The experimenter soon finds out that when breakdown measurements are made in the ordinary way the values obtained vary greatly with such factors as the size and shape of the electrodes, temperature and moisture content, the time of application of the voltage, the frequency, the thickness of the sample, and he is tempted to conclude that the whole idea of electric strength is a myth.

A detailed discussion of the question would be out of place here, but it may be stated that recent research suggests that there is a real electric strength, i.e., a critical voltage gradient not greatly affected by such factors as thickness, temperature, and moisture-content, but characteristic of the structure of the material, at which the material becomes electrically unstable. The value is, however, of the order of 10 or more times that obtained by an ordinary breakdown experiment; that is to say, much more than 10 times the effective electric strength in practice. We must conclude that in practice materials usually break down, not so much because their structure is incapable of withstanding the applied electric field, as because of some extraneous factor. The most important of these factors are the effects of ionisation and the generation of heat within the material. Insulation materials for high voltage work must therefore be considered in relation to these phenomena.

Ionisation and Its Effects

In practice high-voltage conductors and the insulating materials separating them are usually surrounded by air, and this, as has been mentioned in the first article of this series, becomes ionised at voltage gradients considerably less than those at which solids break down. The ionisation may sometimes be observed as

High-voltage Problems—

a luminous discharge, and it has been shown that such discharges in the surrounding atmosphere are usually associated with the breakdown of a solid. The true values of electric strength previously mentioned are only obtained when this ionisation is prevented by, say, enormously increasing the pressure of the surrounding gas, by replacing it by a liquid at high pressure, or by a semi-conducting liquid the conductivity of which tends to prevent the formation of steep local voltage-gradients, or by making experiments with impulses of voltage of such short duration that they allow insufficient time for ionisation.

The way in which the external ionisation leads to breakdown of the solid has not been completely explained. It has been suggested that it is the impact of the swiftly-moving ions with the solid which leads to fracture of the material, or alternatively, that local discharges form irregular conducting paths spreading out from the high-voltage conductors in tree-formation, and therefore virtually adding pointed extensions to these conductors, and that it is the concentration of electric force at these points which causes the breakdown of the solid, the actual voltage gradient at such points far exceeding the apparent value. Whatever may be the exact explanation, it is clear that the behaviour of a material under high voltages is likely to be determined to a considerable extent by the effect which external ionisation has on it. On some surfaces a luminous discharge may cause important chemical changes; on others may merely lead to the accumulation of ions, i.e., of electric charges, in such a manner that their electric field tends to compensate the local steep voltage-gradients and so to stop the discharge. Possibly the high breakdown voltage of ebonite is to be explained in some such way.

Gradual Deterioration

The effects of chemical changes caused by ionisation are likely to take some time to develop, so that they are likely to cause a lowering of breakdown voltage with the time the material is in service. The phenol-formaldehyde synthetic resin compositions tend to break down in the course of time at unexpectedly low voltages by a process which suggests some such action. A discharge appears to creep slowly over the surface of the material, leaving an irregular trail of carbonised material which finally links the two conductors that the material is intended to insulate, and breakdown occurs. This phenomenon of breakdown by "tracking" constitutes a very serious disadvantage to some of the most widely used synthetic resins, and much research has been devoted to the production of special "anti-tracking" resins for high-voltage work. Urea-formaldehyde and aniline-formaldehyde resins are said to be specially useful for this purpose.

It must be emphasised that the

moderate breakdown values of the ordinary resins are not a bar to their use for high-voltage work, but when using them the designer must make his insulators correspondingly larger (and more expensive) in order to keep down the voltage gradients. Obviously a material which admits of the fabrication of large insulators has some advantages. An extreme example is provided by the insulators of the high-voltage transformers of the National Physical Laboratory. These consist of laminated synthetic resin-paper cylinders. The insulator for the million-volt transformer is some 20 ft. high and 5 ft. in diameter and is far more imposing

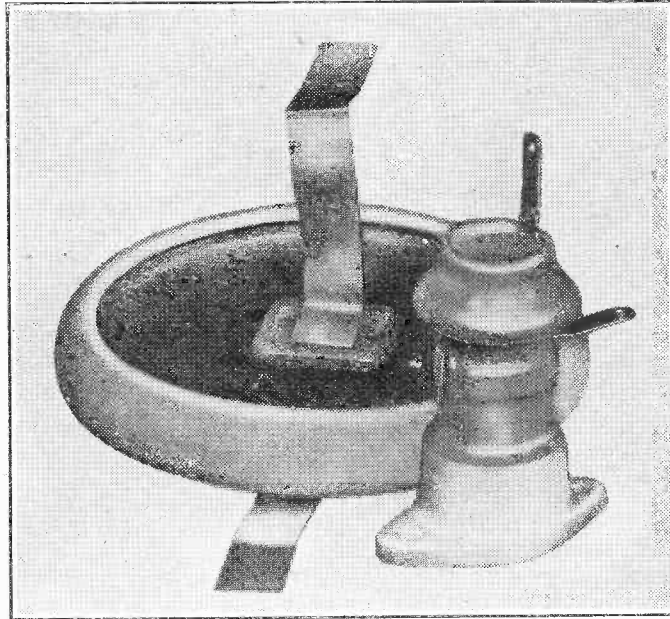

(Courtesy United Insulator Company)

These "pot" and "plate" transmitting condensers owe their powers of resisting breakdown both to the use of ceramic dielectric material and to the avoidance of local concentrations of stress.

than the transformer itself. Obviously a material which can be made in such sizes and has the necessary mechanical strength has great advantages in high-voltage work, although its electric strength may not be specially high.

In many cases, especially at high frequencies, breakdown is caused by the heating effect of the applied voltage. It is well known that every solid material, when placed in an alternating electric field, dissipates energy as heat, the energy dissipated per unit volume varying as the product of the power factor, the dielectric constant, the frequency, and the square of the voltage gradient. Thus at high frequencies particularly, great amounts of heat may be generated at places where the voltage gradient is large. As long as the heat is conducted away by the electrodes and the material at low gradients, all is well, but if the rate of generation of heat at any spot exceeds the rate at which it is conducted away, the temperature of the spot steadily rises until the material is either melted or burnt and a breakdown occurs, something like the blowing of a fuse. It is obvious that a condition which tends to make such breakdowns less probable is a low "loss-factor" or product of dielectric constant and power factor. Materials which satisfy this condition are the hydrocarbon resins, like Distrene and Trolitul, both forms of polymerised

styrene, and Polythene, or polymerised ethylene, a new material recently developed by I.C.I.; and also the ceramic materials, particularly those of the steatite class.

Ceramic insulators for high voltage work of all kinds are such a familiar sight that there is no need to stress their value. The new high-frequency ceramics of the steatite and titanium oxide classes have special advantages for the construction of high-voltage condensers. The plates of material can be moulded into such a form that local concentrations of stress are avoided. Thus discs with their edges thickened and rounded are used, the elec-

trodes consisting of metal films coating the faces of the discs. The compactness and simplicity of the construction may be realised by comparing it with that of the corresponding air or oil condenser.

The ceramic materials have the additional advantage that they are capable of withstanding the action of very high temperatures without damage. Mycalex also

possesses these advantages to a considerable extent and is, moreover, capable of being machined. It is therefore specially valuable for research and development work.

The hydrocarbon resins, although lacking resistance to heat, have the very valuable property of flexibility. In this respect Polythene is specially remarkable. Its external appearance suggests paraffin wax, but its flexibility suggests rubber. It can scarcely fail to have many applications in high-voltage work, but these have yet to be explored.

Temperature and Power Factor

Another point of some importance is the variation of power factor with rise of temperature. The power factor of many materials increases with temperature, in which case the more the temperature rises the greater is the rate at which heat is generated, a condition which will obviously lead to instability. If, on the other hand, the power factor diminishes with rise of temperature, the rate of generation of heat diminishes as the material heats up, a condition which obviously favours stability. It is for this reason that American whitewood, a material which cannot be regarded as a "low-loss" dielectric in ordinary use, has proved of special value for transmitters and high-voltage high-frequency work generally.

High-voltage Problems—

Provided the wood is fairly dry its power factor diminishes with rise of temperature, probably due to further loss of moisture. Thus the material becomes warm in a strong high-frequency electric field, but does not readily become unstable.

Low-loss glasses of high melting point and fused quartz also have obvious advantages in situations where thermal breakdowns are possible, but their brittleness constitutes a serious limitation to their use.

It was stated at the outset that the direct chemical attack on high-voltage problems has achieved no very obvious successes. It is only fair to mention that it has achieved one result which has affected American high-voltage practice so strongly that enthusiastic chemists have declared that dielectric breakdown is essentially a chemical problem, that "the physical manifestation of breakdown only follows the deterioration produced by chemical changes," and that the remedy therefore lies in the hands of the chemist, who must prevent the chemical changes by producing pure materials of great chemical stability. The foregoing discussion of types of breakdown show that the statement, taken in a general sense, is only

partly true, but its significance is best understood in relation to insulating oils for high-voltage power engineering. For many years mineral oils, mostly mixtures of paraffins, were universally used as impregnation and immersion media in condensers, transformers, etc. These natural oils are by no means completely stable, even when highly refined. They are inflammable, for example, and oxidise in the course of time to form acid products, and when breakdown occurs it is often the result of contamination following chemical changes. The chemist has now synthesised liquids for which many advantages are claimed. An example is chlorinated diphenyl (Permitol), which until recently was little more than a chemical curiosity but is now an important industrial material. It is stable, does not oxidise, is not inflammable, and is stated to have a normal electric strength 30 to 50 per cent. higher than that of comparable mineral oils. From the point of view of condenser construction, its greatest advantage is its high dielectric constant, which has a value of 5 as against 2.2 for the paraffins. The result is that the bulk of the condenser per kilovolt-ampere is considerably reduced, and costs are correspondingly reduced in many directions.

Random Radiations

Olympia Almost With Us

HOW time runs along! It seems no time since we put the clocks forward for B.S.T.; yet here we are with Radiolympia almost upon us and in sight of the end of the summer that, so far, we haven't had. One seems to have had less advance news of the Wireless Exhibition than in previous years; there have been fewer hush-hush stories, fewer hints of big surprises to come. That's perhaps why it's difficult to realise that the Exhibition is less than a fortnight away when you read this. In past years we have been gently led up to the opening of the Show; this year we have more or less suddenly awakened to its imminence. However, it is imminent, and that's the great thing. Possibly because there have been so few dark hints of startling novelties I am looking forward to it with more keenness than usual. I know that it is going to be interesting, and I particularly want to see the results of a year of consolidation rather than of breaking new ground.

Consolidation

At former shows a good deal of what one has seen has been to some extent untried. Press-button tuning, for instance, was more or less in its infancy in 1938; manufacturers didn't quite know what to offer because they weren't sure whether or no the public really wanted it. Now they know right enough. They have had twelve good months in which to develop and improve their systems, with no fresh hares started to divert their energies into other channels. They should, then, have been able to evolve methods of outstanding excellence. There are signs that the old and hateful craze for price-cutting is less rampant, which should mean better receivers. I hope there will be

By "DIALLIST"

some examples of what the 1939 receiver really can be if designers are given a freer hand than has been theirs in the past, and are not constantly reminded of the importance of "saving" every possible halfpenny.

Things I'd Like to See

Here are some of the things I should like to find at Radiolympia, though I'm afraid I shall be disappointed. First of all, standard aerial and earth plugs for all sets. Next, provision in every set of the short-wave or "all-wave" type for the use of a dipole aerial if desired. Thirdly, standardised arrangement of the control knobs, so that you always know which is which, whether its purpose is indicated by lettering or not. Those are three needed reforms that it should be very simple to carry out. If this year doesn't bring them, perhaps another will. They're not the only things I'd like to see. I should be glad to find no small or odd-shaped tuning knobs; large, round ones with milled edges are by far the most pleasant to use when it comes to anything like fine tuning. And wouldn't it be jolly to discover that manufacturers had decided that such things as oscillator creeping, backlash in the tuning, second-channel squeals and break-through should have no place in the modern receiver? Hum I do hope to find more effectively dealt with in the 1939 sets than in not a few of last year's.

Gas Radio

FOR years experimenters have been toying with the idea of a radio set operated entirely from the gas mains. Apparatus that worked has actually been produced; current

from thermo-couples has heated filaments or supplied plate circuits. But all such devices have had one fatal drawback. The inefficiency of the thermo-couple has been such up to now that the cost of providing the necessary heat was out of all proportion to the current obtained. Now, as a result of much research, the Milnes people have evolved a thermo-couple generator so relatively efficient that it delivers one watt-hour of current for one cubic foot of coal gas—say, one two-hundredth of a therm, or 500 B.Th.U.'s. Since one watt-hour is equivalent only to 3.412 B.Th.U.'s, the efficiency is still relatively low; but it is a considerable advance on anything that has been done before, and, with gas at 6d. per therm, it means that a six-valve wireless set can be run at a cost of about 0.4d. per hour, or £1 13s. 4d. for a year of 1,000 hours' listening.

Ingenious

The output of a multiple thermo-couple generator recently produced is 8 watts. Of this two watts (2A at 1V) are used for direct filament heating, and the remaining 6 watts for operating a vibratory converter with an output of 20 milliamps at 150 volts. I hear that burners for various kinds of gas have been designed, so that those who have acetylene or petrol gas-lighting plants would be able to use the converter as easily as those who have mains supplies of coal gas. I don't know whether a paraffin burner has been worked out, but I can't see why it should not be done. If the device proves completely satisfactory, it should have a great future; for the homes in this country without mains supplies of electricity but with gas of one kind or another must run a long way into seven figures. Its coming may lead to the production of bigger and better battery sets; in the interests of economy the tendency now is to keep the LT load down to as near 0.6 ampere as possible and the HT load to as near 10 milliamps as may be; given a whole ampere of LT current and 20 milliamps of HT at 150 volts to play with, designers should be able to turn out some fine receivers.

Cooler Light

AT Schenectady they have developed a new and special kind of illumination for their television studios. They found that in the studios roughly twice as much light was needed as in those devoted to cinema work. Cinema lights are hot enough in all conscience, as you'll admit if ever you have been submitted to their beams for an hour or so; double as much illumination by similar methods would have been unbearable. The new lamps consist of water-cooled quartz mercury arc units, and it is claimed that not only do they radiate little heat but they are also more than twice as efficient as incandescent lamps. Twelve quartz lamps, each rated at 1,000 watts, together give off 780,000 lumens; the figure for incandescent lamps of the same wattage would be 330,000. Each 1,000-watt tube is about the size of a cigarette and enclosed in a quartz jacket. There is a second, outer quartz jacket, and between the two water circulates at the rate of six pints a minute. It is claimed that the water absorbs 90 per cent. of the heat, and that the studio remains cool. I've converted the water flow to pints, for "three quarts a minute circulating between the quartz jackets" looked rather queer in the account sent to me from Schenectady! You see my pint?

Modern Detector Circuits

EFFICIENCY, QUALITY,
INPUT DAMPING
AND AVC

IN receiver design the detector still offers considerable difficulty, for there are so many possibilities that it is often hard to know what to do. The commonest detector to-day is the diode, but the others still have their sphere of usefulness, and there are cases where the grid detector, the anode-bend detector, or the "infinite input impedance" detector may prove better.

A complete discussion of all aspects of detection is impossible in an article; it is a subject for a book and a highbrow one at that. The usual practical difficulties, however, arise not so much in the detector itself, considered as an isolated unit, as in its association with the rest of the receiver. As it usually occurs, the problem is to connect a valve so that it provides an undistorted AF output from a modulated RF input which is developed across a tuned circuit of good efficiency. The detector must not damp this tuned circuit heavily, or else efficiency and selectivity will suffer; in some cases, even, the detector must provide regeneration.

In addition to the undistorted AF output, the detector is usually required to

THE characteristics and circuits of the most usual forms of detector are described in this article. Commencing with the diode, the author goes on to deal with the grid, anode-bend and negative feed-back detectors, and points out their advantages and their limitations. In the following article, a special method of feeding the diode will be discussed and will be shown to offer important advantages.

By W. T. COCKING

It will be clear that to obtain all these things from a circuit which is simple, reliable and inexpensive is by no means easy. In fact, many of the requirements are mutually conflicting, and the skill of the designer is shown by his compromise between the claims of the various factors.

The diode detector is unquestionably the most widely used to-day and its popularity is due to its being cheap and reliable, to its giving good quality and high efficiency, and to its readily providing an AVC voltage. Its main disadvantage is that it damps the input tuned circuit fairly heavily, especially if it is designed for the highest quality. The compromise is essentially between quality and input resistance, and if the standard of quality is made high, selectivity and efficiency suffer severely through heavy damping of the input circuit.

Although there are many minor variations to be found, most diode detectors take the general form shown in Fig. 1, where the purely detector portion lies in the dotted box. The last IF valve V_1

the detector through C_1 , which performs exactly the same function as the reservoir capacity of an HT rectifier. For high efficiency and good filtering C_1 should be large, but for a good response at high audio frequencies it should be small. Right at the start we find the need for compromise and C_1 is usually 100-500 μF ; the capacity tends to be smaller when the designer considers quality important than when he is more concerned with efficiency. The value is intimately related to that of the load resistance, however, and from the quality point of view it is more the RC product of capacity and load resistance that is important than the capacity alone. If the resistance is abnormally low, therefore, it is correct to use an unusually large capacity.

The components R_1 and C_2 form a filter to prevent the IF potentials which are developed across C_1 from appearing in the output to any appreciable extent; R_1 is often replaced by an RF choke, which may give better filtering, but which is more expensive and occupies more space. For good filtering R_1 and C_2 should be large, but for a good high-frequency response they should be small. Again compromise is needed, and it is really the product R_1C_2 which counts. Usual values are 10,000-50,000 Ω for R_1 and 100-500 μF for C_2 .

The resistance R_2 shunting C_2 forms the major part of the diode load resistance to direct current, and it also serves as the volume control, the output being taken off the slider through C_3 to the grid of the AF valve V_3 . The resistance R_3 is included to complete the grid circuit of V_3 . The steady voltage across R_2 is used for AVC and is taken off through R_4 , which acts in conjunction with C_4 as a filter to remove the audio-frequency components.

The Diode Circuit

The DC diode load is actually $R_1 + R_2$, while the AC load is R_2 , R_3 and R_4 in parallel, plus R_1 . The maximum modulation depth which the detector can handle without distortion is approximately equal to the ratio of the AC to the DC loads. Thus if R_1 is 10,000 ohms and R_2 is 0.25 megohm, the DC load is 0.26 megohm. If R_3 and R_4 are each 0.25 megohm, the AC load is 0.093 M Ω , so that the maximum modulation depth is $0.093/0.26 = 0.357 = 35.7$ per cent.

This is, of course, absurdly low, but it

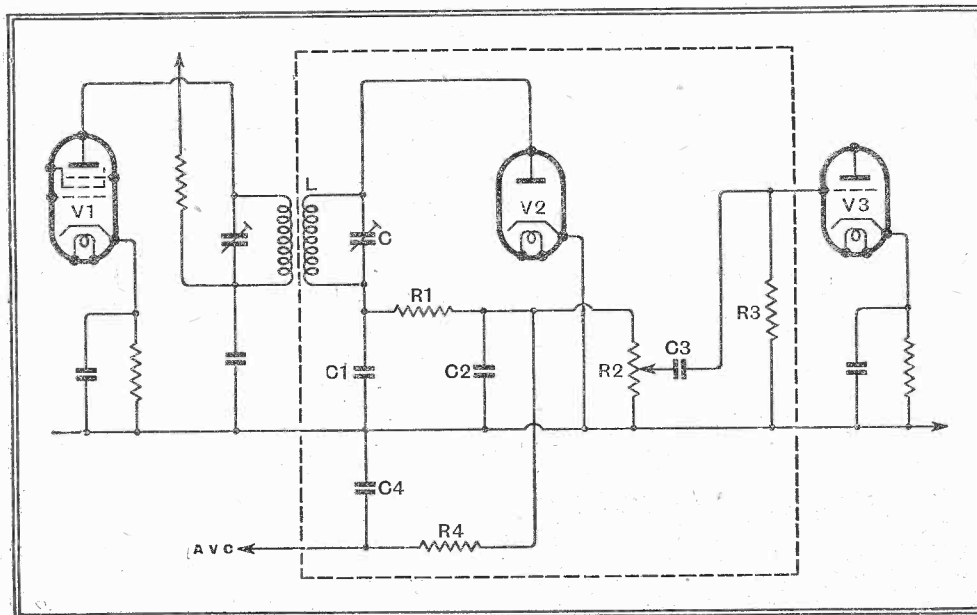

Fig. 1. This diagram shows the usual arrangement of a diode detector V_2 between an IF stage V_1 and an AF amplifier V_3 .

provide a voltage output more or less proportional to the mean RF carrier level and with a polarity negative with respect to a fixed point such as earth; this is for AVC. At one time the detector had to amplify also, but this requirement is less often insisted upon nowadays.

feeds the detector V_2 through an IF transformer consisting of a pair of coupled tuned circuits, the secondary of which, LC, is damped by the detector. The AF output developed across R_3 is applied to the AF stage V_3 .

The RF voltage across LC is applied to

Modern Detector Circuits—

well illustrates the importance of making the ratio of the load resistances as high as possible. There are, however, limits to the values of R3 and R4. If V3 is an output valve, R3 can hardly be above 0.5 megohm, but if it is a small triode AF amplifier it can usually be about 2 megohms. Similarly R4 is limited in value. The total resistance in the grid circuits of the

ately, however, an increase in R1 reduces the overall efficiency, because only the fraction of the detector output which appears across R2 can be used. Nevertheless, within limits it is probably better to increase R1 than to reduce R2. In the average practical case, however, the values used are of the order just given and distortion is liable to occur on modulation depths much greater than 70 per cent.

leak R1 corresponds to the DC load resistance R1+R2. The AC and DC loads are equal, so that there is no modulation limitation.

Normally C1 is about 100 μμF and R1 is made of the order of 0.25 megohm. The input resistance damping LC thus tends to 0.125 megohm, but may be lower with small signal inputs. The rectified signal, which comprises both AF and DC components, is developed on the grid of V1, which also has the IF signal on it. All these components appear in the anode circuit, therefore, and the IF filter is connected at this point.

Circuit Values

It is more usual for an RF choke to be used for R2, but this resistance is sometimes more convenient; a suitable value is 5,000 ohms. The condenser C2 should be about 0.002 μF with a triode for V1. If it is too small not only will the filtering be poorer, but there will be feed-back at intermediate frequency through the grid-anode capacity of V1. This will result in a considerable increase in the damping on LC. This effect is avoided with a screened tetrode or pentode, and C2 can then be smaller.

The coupling resistance is R3 and should normally be 30,000-50,000 ohms, while the filtering condenser C3 should be 500-1,000 μμF. Decoupling is provided by R5 C5 and the values will depend on the HT voltage and the amount of AF amplification following V1; C4 R4 are the usual AF coupling components to V2 and can have normal values.

A triode with an AC resistance of 10,000-15,000 ohms and an amplification factor of 20-40 is best for V1. The HT voltage should be high so that the no-signal anode current is 8-10 mA.; this usually calls for 400 volts or more. With the optimum signal input the detector is very nearly distortionless; it is appreciably better than the diode as commonly used. Moreover, the valve gives quite good amplification.

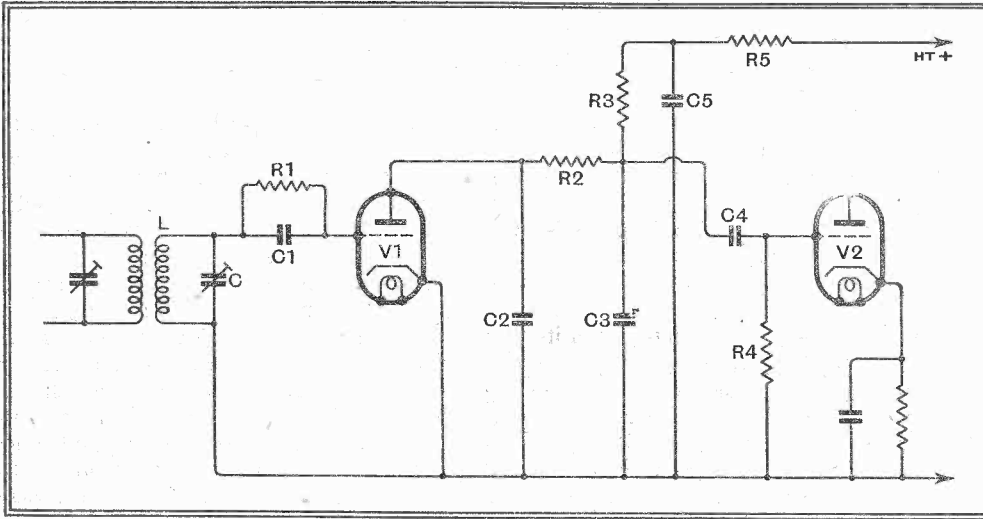

Fig. 2. The grid detector usually takes this form. The valve V1 really functions as a combined diode detector and AF amplifier.

valves controlled from the AVC system should not exceed about 2 megohms divided by the number of controlled valves. For this circuit R2 counts as 0.5 megohm, assuming two controlled valves, leaving 1.5/2 = 0.75 megohm for R4.

Taking these values, the AC load becomes $0.01 + 1 / (\frac{1}{0.25} + \frac{1}{0.75} + \frac{1}{2}) = 0.181$ megohm. The ratio of the AC and DC load resistances is then $0.181 / 0.26 = 0.7$, or 70 per cent. modulation. This is much better, but does not seem very good when it is remembered that modulation depths up to 90 per cent., or even 100 per cent., are encountered. Fortunately, in practice, matters are somewhat better; except for unusually strong signals, distortion does not set in until the modulation depth exceeds the theoretical figure by a small amount.

So far as carrier frequencies are concerned, the input resistance of the detector is approximately one-half the DC load resistance, or 0.13 megohm in this case. This shunts the circuit LC and damps it quite heavily, reducing the efficiency and selectivity. If we reduce the value of R2 in order to increase the ratio of the AC to DC load resistances, we reduce the input resistance, with the result that we lose in both efficiency and selectivity. There is also an increased risk of amplitude distortion in the last IF valve V1, because with poorer efficiency in LC this valve must handle a bigger input to maintain the same detector input.

Alternatively, we can improve the ratio of AC to DC loads by increasing R1. This also increases the input resistance and so improves the efficiency and selectivity of LC, which is very desirable. Unfortun-

It is important to note that if it were not for the reduction in the efficiency occasioned by the use of a lower value of R2, little difficulty would arise. The DC load could be made considerably smaller so that modulation depths of 90-95 per cent. could be handled; in fact, the only limitation to the value of R2 would be the general curvature of the valve characteristic. Even this could be overcome by using one of the low-resistance television diodes.

After the diode, the grid detector is one of the most important, and a typical circuit is shown in Fig. 2. The valve V1 is a triode, but a tetrode or pentode can be used. The grid-cathode path of the valve acts as a diode. The condenser C1 corresponds to C1 of Fig. 1 and the grid

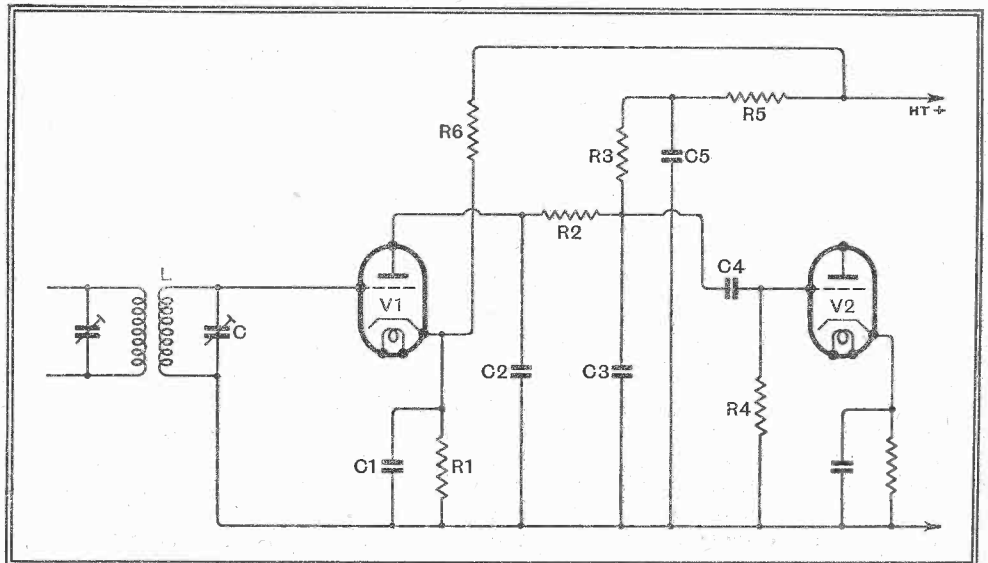

Fig. 3. With the anode-bend detector the input tuned circuit can be only slightly damped. The resistance R6 is often omitted.

Moderate Detector Circuits—

This detector consists really of a combined diode detector and AF amplifier, and it is only better than the average diode if it is operated under ideal conditions. If the signal is too small, the diode section introduces distortion. If it is too great the amplifier section overloads; it is to avoid this that a high value for the HT supply is needed. The signal input must be large enough to avoid the one and not so large that the other is introduced.

This makes the detector rather difficult to use, unless post- and pre-detector gain controls are fitted and operated intelligently in conjunction with a calibrated meter. If the highest standard of quality is not aimed at, a smaller detector input can be used and there is then much greater latitude. The detector has the great advantage that it will easily provide reaction effects, and because of this it is nearly

must be fairly small if the high frequency response is to be maintained, 100-500 $\mu\mu\text{F}$. is suitable.

The valve V_1 can be a triode of moderate to high AC resistance, or a tetrode or pentode can be used. With a triode there is appreciable damping of the input circuit LC because of the feed-back through the grid-anode capacity. This feed-back is appreciable since C_2 cannot be large in view of the high circuit resistances. A tetrode or pentode is to be preferred, therefore, and the detector then imposes very little damping on the input circuit. This is, in fact, the great merit of the detector, for the normal efficiency and selectivity of LC are retained.

Negative grid bias is obtained by the cathode resistance R_1 , which is shunted by a large capacity C_1 to avoid feed-back effects. R_6 is provided to bleed extra current through R_1 and so maintain the

and C_4 are merely decoupling components. The valve functions as an anode-bend detector with the load resistance in the cathode circuit; as a result, the whole of the AF output across R_1 is applied back to the grid as a form of negative feedback.

The result is that the detector gives no amplification, but slight attenuation. The purely detecting efficiency is of the same order as that of a diode. As the input resistance is normally very high, however, the input circuit LC is substantially undamped. Because of this LC is more efficient and more selective than with a diode and the overall efficiency is greater than with this detector.

From the point of view of quality the negative feed-back detector is at least as good as the diode and is often better, since it is largely free from the necessity for maintaining a very high ratio of AC to DC load resistance. It is also easier to maintain such a ratio if it is ever needed.

In general, the valve can be a triode of about 10,000 ohms AC resistance and with an amplification factor of 20; it is by no means critical, however. R_1 and C_1 can be 50,000 ohms and 500-1,000 $\mu\mu\text{F}$, with the RF filter R_2 and C_2 10,000 ohms and 500 $\mu\mu\text{F}$ respectively. The decoupling resistance R_4 can well be 10,000 ohms, with an 8- μF decoupling condenser C_4 ; sometimes it is advisable to shunt C_4 by a 0.1- μF condenser, since an electrolytic condenser is not always effective at radio frequency. Usual values for the AF coupling components C_3 and R_3 can be employed, say, 0.05 μF and 0.5 megohm.

Because of the grid-cathode capacity of V_1 , there is IF feed-back to the input circuit. When the cathode load is capacitive this may make the input resistance negative. In other words, the stage is regenerative. With a good circuit LC and a suitable value for C_1 , oscillation can be obtained. Increasing C_1 above a certain figure or reducing it below another figure makes the input resistance positive. In other words, the input resistance is only negative over a certain range of values of C_1 .

The detector is remarkably linear and is not easily overloaded. From the point of view of quality it is very good indeed and it enables much higher efficiency and selectivity to be obtained from LC than with a diode. Its drawback is that it cannot provide AVC.

Instead of using the full negative feedback, a compromise between this arrangement and the ordinary anode-bend detector is sometimes used. The circuit then takes the form of Fig. 3, but with R_6 removed. Normal values of components are used, save for C_1 , which is made about 0.001 μF only, with R_1 some 5,000-10,000 ohms. The detector operates with better linearity and lower gain than when C_1 is large, because of the feed-back across R_1 . The linearity is not as good as with the full feed-back of Fig. 4, but the detector gives appreciable gain instead of slight attenuation.

(To be concluded.)

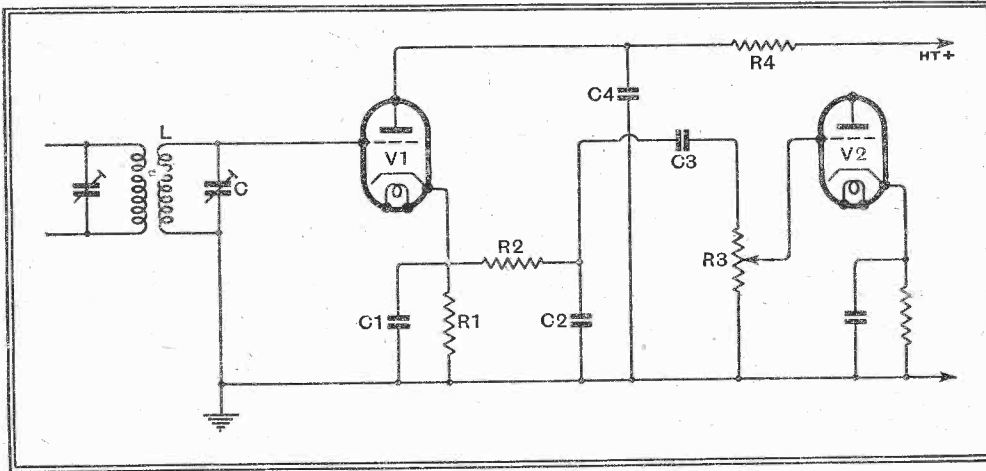

Fig. 4. The negative feed-back anode-bend detector has the load resistance in the cathode lead. Its efficiency is of the same order as that of the diode, but the input circuit is undamped; in fact, regeneration can be obtained.

always used in receivers which rely on reaction to any degree.

The greatest disadvantage of the grid detector is that it does not fit in well with AVC. It is difficult to utilise the change of anode current with signal input; it can be done, but the arrangement is rather complicated and troublesome. The steady voltage developed on the grid, and analogous to the voltage across a diode load, is too small for AVC purposes. It is possible to utilise the IF component of the anode current to feed a diode detector in order to obtain an AVC voltage, and this is probably the best arrangement when V_1 is a tetrode or pentode. In general, however, the maximum input needed by a grid detector is too small to fit in with simple AVC systems.

The anode-bend detector, Fig. 3, is not often used nowadays, but it has its advantages. With the exception of R_1 , C_1 and R_6 , all components in Fig. 3 perform the same functions as the corresponding ones in Fig. 2. The valve V_1 is biased nearly to anode-current cut-off, and has a high AC resistance, unless a large signal is applied. Because of this and because of the low anode current R_3 is made of high value, usually 0.1-0.25 megohm. In view of the high resistances, C_2 and C_3

bias constant. In practice, however, R_6 is often omitted. The bias is then dependent on signal strength and increases with an increase in the input. This makes the valve capable of handling a larger input before overloading and grid current occur.

The detector cannot well supply an AVC voltage and it is not usually very good for regenerative purposes. It can be overloaded fairly easily, although it is much better than the grid detector in this respect. At all inputs, however, it is liable to introduce appreciably more distortion than even a moderately good grid detector.

We now come to the latest detector, the so-called infinite input impedance detector. This is not a good term for it, for it is not only clumsy but inaccurate. The input impedance can be made infinite, but is usually finite and either positive or negative. Since the detector is really an anode-bend detector with heavy negative feedback, a better term is the negative feedback anode-bend detector, perhaps equally clumsy, but more accurate.

The circuit is shown in Fig. 4, and the signal input developed across LC is applied between grid and cathode of the triode V_1 through C_1 . The load resistance is R_1 in the cathode circuit, for R_4

The Wireless World Pre-tuned Quality Receiver

MEDIUM AND LONG WAVES
WITH TELEVISION SOUND

THE quality enthusiast often finds that he confines his listening chiefly to the local stations and only occasionally listens to distant transmissions—even then he chooses only the more powerful stations. His requirements are probably best met by a receiver in which the desired stations are pre-tuned and selected by some form of switching. Apart from convenience, there is the technical advantage over a conventional tuning system that the band-width of the RF circuits can readily be adjusted independently for each station, so that the optimum compromise between selectivity and quality is obtainable in each case.

The Pre-tuned Quality Receiver allows a choice of six stations, of which one is on ultra-short waves, three are on medium waves and two are on long waves. The particular stations selected depend on the ideas of the user, but a typical example which suits the London area is Television Sound, London National and Regional, North Regional, Droitwich and Radio-Paris.

Two RF stages with low-noise heptodes are used and followed by a negative feedback anode-bend detector. There are three tuned circuits, and separate trimmers are provided for each station. A six-way multi-pole switch allows the correct trimmers for each station to be selected. On ultra-short waves air-dielectric trimmers are employed, but mica-types are used for the other bands.

It is intended that one tuned circuit shall always be tuned to resonance with the desired signal, and the other two mistuned in opposite directions to give a band-pass effect.

The amount of mistuning can be different for each station, thus making it possible to attain the best quality that the interference conditions will permit. This results in a considerable improvement in the reproduction, which is especially noticeable in the case of long-wave stations, such as Droitwich.

A tone-control stage follows the detector and enables the bass and treble responses to be independently varied. It is switch-controlled and twenty-five different response curves are obtainable. Following this is a resistance-coupled push-pull amplifier giving an undistorted output of some 7 watts. The apparatus is AC-operated.

In Next Week's Issue

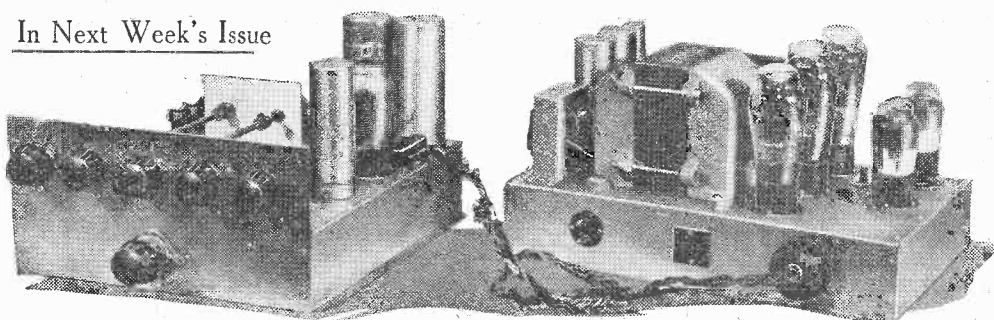

LIST OF PARTS

Receiver.

Condensers:

- 2 0.015 mfd., tubular
- 2 0.025 mfd., tubular
- 6 0.1 mfd., tubular
- 2 0.25 mfd., tubular
- 2 0.0002 mfd., mica
- 4 0.001 mfd., mica
- 1 0.01 mfd., mica
- 1 8 mfd., electrolytic, 500 volts
- 1 8-8 mfd., electrolytic, 500 volts
- 1 50 mfd., electrolytic, 12 volts
- 3 Trimmers, 1-30 mmfds.
- 3 Trimmers, 175 mmfds.
- 6 Trimmers, 300 mmfds.
- 6 Trimmers, 600 mmfds.

Resistances:

- 3 300 ohm, 1/2 watt
- 1 350 ohm, 1/2 watt
- 1 5,000 ohm, 1/2 watt
- 2 10,000 ohm, 1/2 watt
- 1 40,000 ohm, 1/2 watt
- 1 50,000 ohm, 1/2 watt
- 1 2 megohm, 1/2 watt
- 2 12,000 ohm, 1 watt
- 1 6,500 ohm, 2 watt
- 1 10,000 ohm, 2 watt
- 1 Potentiometer, 0.25 megohm, tapered
- 1 Potentiometer, 10,000 ohms, wire-wound

- 1 Aerial Transformer, medium-wave
- 2 RF Transformers, long-wave
- 1 Aerial Transformer, long-wave
- 2 RF Transformers, USW (see text)
- 1 Aerial Transformer, USW (see text)
- 1 Length, 8 in., 1/4 in. rod
- 1 Length, 8 1/2 in., 1/4 in. rod
- 2 Lengths screened sleeving
- 2 Double-pole, 6-way, switches
- 1 Switch, DPDT, rotary
- 2 Shaft couplers, 1/4 in.
- 2 Panel bushes, 1/4 in.
- 5 Terminals A(2), E, PU(2)
- 1 Valve screen
- 1 Valveholder, 5-pin
- 1 Valveholder, 7-pin
- 2 Valveholders, 8-contact
- 3 Valve top-clips
- 1 Connector, 5-way
- 1 Cable, 6-way, with twin 70/36 leads

- Chassis, Aluminium
- Valves:
- 2 EF8(met.) 1 354v (plain), 1 TSP4 (met.)

Amplifier.

- 1 Mains transformer:
- Primary, 200/250 V, 50 c/s; Secondaries, 350-0-350 V, 150 mA; 4 V, 2 A CT; 4 V, 2 A; 4 V, 3 A; 4 V, 3 A; 6.3 V, 0.4 A.
- 1 Smoothing choke, 10H, 150 mA, 100 ohms
- 1 Smoothing choke, 20H, 50 mA, 400 ohms

Condensers:

- 2 0.01 mfd., tubular
- 2 0.1 mfd., tubular
- 1 4 mfd., electrolytic, 500 V
- 1 8 mfd., electrolytic, 150 V
- 2 8 mfd., electrolytic, 500 V
- 1 50 mfd., electrolytic, 50 V

Resistances:

- 2 50 ohm, 1/2 watt
- 1 600 ohm, 1/2 watt
- 2 10,000 ohm, 1/2 watt
- 2 40,000 ohm, 1/2 watt
- 1 150,000 ohm, 1/2 watt
- 2 2 megohm, 1/2 watt
- 2 0.25 megohm, 1/2 watt
- 1 15,000 ohm, 1 watt
- 1 400 ohm, 20 watt
- 1 20,000 ohm, wire-wound potentiometer

- 3 Valveholders, 4-pin
- 2 Valveholders, 5-pin
- 1 Valveholder, 7-pin
- 1 Cable plug, 7-pin
- 1 Plug and socket, 3-way
- 1 Plug and socket, 2-pin, mains input connector
- Chassis
- Valves:
- 1 FW4/500, 2 AC044, 2 354v (plain)

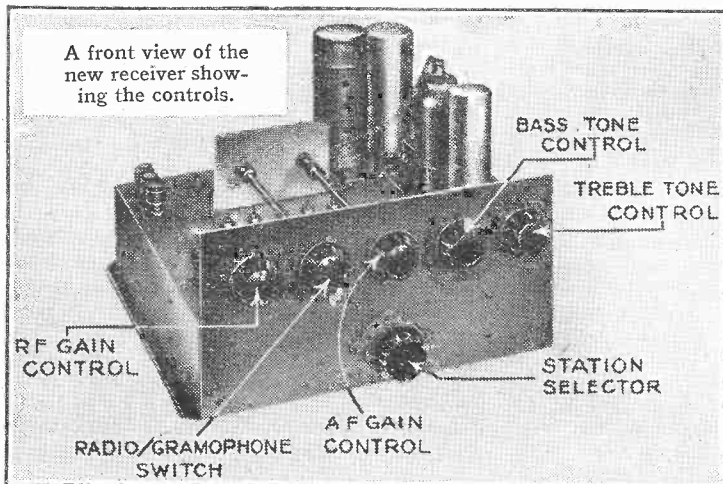

A front view of the new receiver showing the controls.

- 1 Choke, 0.75 H., tapped at 0.2 H.
- 1 Switch Assembly, 6-way, comprising locator, and 12-inch rod, 3 single-pole plates and 3 double-pole plates (without earthing plates)
- 2 RF Transformers, medium-wave

Letters to the Editor

The Editor does not necessarily endorse the opinions of his correspondents

Reproduction Level : "Unreal Conditions"

IN view of "Cathode Ray's" very interesting letter in your issue of June 22nd, I would like to re-enter the discussion, which I originally precipitated, on reproduction levels.

I have not previously come forward to reply to Messrs. Pacent and Likel's letter in the issue of May 18th, because I had not looked on their courteous letter as a criticism of my original letter. On the main fundamental issue, in fact, it appears that we and "Cathode Ray" are in complete agreement. That issue is that, with perfect reproduction, the reproduced level must be "correct." That point, too, appears to have been widely accepted by your other correspondents on this subject.

Beyond this point a confusion now appears to have arisen between two totally different considerations. May I try to clear this up?

Briefly, the view I expressed originally was that, for perfect reproduction, the "correct" level is essential, and that compensating networks are therefore unnecessary. Messrs. Pacent and Likel, in their letter, agreed with this in principle, but argued that, because of disturbance to neighbours, the "correct" level is often impracticable, and that, therefore, compensation will be necessary in those cases. "Cathode Ray" has avoided what, to me, is the interesting part of this view and has concentrated on showing that the "correct" level is practicable. Now, with all due respect to "Cathode Ray," may I say that I think he is getting on uncertain ground in disputing that part of Messrs. Pacent and Likel's opinion in all cases. I would concede that in many flats and modern "semi-det. villas" the "correct" level is impracticable, whereas we know that, in more favourable circumstances, there is nothing to prevent real high-quality listening. Would it not be better to drop that barren part of the discussion, which, after all, depends on the circumstances? We can at least all agree that these small-flat dwellers form an unlucky group to whom high-fidelity radio is an impossibility.

What does seem interesting and important is a point I made in my original letter, and which all your correspondents, including "Cathode Ray," have ignored, but on which Messrs. Pacent and Likel and myself still appear to be in disagreement.

The point is whether, if an "incorrect" level is necessitated by neighbours (or other pests!), we are even then justified in using networks to alter the balance of the output in order to give to soft music that "tonal balance" which should be peculiar to loud music. My reply to this was, and still is, that "tone correction" is always wrong. If we must have our music softly, then let it sound like real soft music. As I said in my original letter, *by no natural means is it possible to hear music softly and yet preserve the same "tonal balance" as exists when it is heard loudly. Why, then, should we try to introduce this unreal condition into our "high-fidelity" radios?*

I think I can justly claim that this point is an original one, and it seems to me to be

well worth discussion and investigation. Particularly would I like "Cathode Ray's" views concerning it.

J. R. HUGHES, A.M.I.E.E.
London, S.E.7.

"Free Grid's" Speed Indicator : Henry Farrad's Explanation

I HAVE pleasure in accepting "Free Grid's" challenge to deduce the cause of the detuning noticed by his airman friend when power diving towards Brookmans Park transmitter, because in spite of the elementary nature of the problem it presents certain features not entirely devoid of interest. It is, of course, an example of the Doppler principle, well known to small boys standing on station platforms when expresses roar through with whistles blowing. As Einstein has pointed out, frequency, like most things, is relative; and although to the engine driver, whose velocity relative to the whistle is nil, it emits a note of constant pitch or frequency, to the small boy whose velocity relative to the whistle changes rapidly from perhaps -100 feet per second to +100 feet/sec. the frequency changes correspondingly.

Similarly in the radiation from Brookmans Park, with a wavelength of 342.1 metres, travelling outwards at 300,000,000 metres per second. A fixed receiving station therefore notices $\frac{300,000,000}{342.1}$ or 877,000 complete waves or cycles per second (877 kc/s) as may be checked by consulting the official lists. If the receiving station is moving towards the aerial, however, its velocity relative to the waves is greater than 300,000,000 metres/sec., and the frequency is higher than 877 kc/s, so that the set is no longer in tune. Assuming that it is 880 kc/s in order to cause appreciable fading in a selective receiver, the relative velocity is seen to be 301,000,000 metres/sec., so the plane is approaching the aerial at 1,000,000 metres/sec. or 2,236,000 miles per hour.

I hesitate to point this out to "Free Grid," because certain Foreign Powers would no doubt make it so much worth his while to hand over his friend complete with machine that even his iron integrity might be painfully strained.

"HENRY FARRAD."

Radio and A.R.P.

IF a mere onlooker may contribute to the discussion which has been started by the amateur transmitters, I would suggest that the use of radio for A.R.P. work has been banned in order to keep all available channels clear for the use of the "active" fighting forces, as distinct from the "passive" defence.

In time of war the destruction of the enemy would claim priority, and the defence of the civilian population would be of strategic importance only in so far as excessive civilian casualties would damage either industrial supplies to the fighting forces or the prestige of the Government. One can imagine that a few installations of the type mentioned by M. C. Stanley, "heavily modulated, unstabilised transmission on 60 Mc/s," and using three channels

per station, might easily cause chaos in the frequency bands concerned, in spite of low power and the utmost care in observing correct signalling procedure. In the absence of any official explanation I suggest that this is the most likely reason for depriving A.R.P. services of the assistance which they could obtain from radio communication.

D. A. BELL.

Chelmsford, Essex.

Wireless in the O.T.C.

IT was with great interest that I read Corporal Stanley's letter in *The Wireless World* of July 13th.

The formation of a wireless section in the O.T.C. seems to offer great possibilities in the way of training in morse and in the operating procedure used in the Army. In the two years that the average member spends in the O.T.C. a sound foundation would have been built up, which would speed up any later training in the Army. This training would also go a long way to counteract the lack of efficiency to which Sgt. Garnett attributes the unsatisfactory performance of many amateurs joining the Signals.

J. FORBES.

London, S.W.1.

"In Praise of Television" : Comparisons with the Cinema

IT would not have surprised me if people whose experience of television is nil or limited to an unlucky demonstration had thought it presumptuous of me to compare television picture quality with that of the cinema; so Mr. Jeffery's claim that television is actually superior was more than I expected. I cannot lay my finger on chapter and verse, but I had thought it was generally accepted that definition in a picture projected from standard cinema film is equivalent to television with considerably more than 405 lines—something like 700; perhaps someone expert in both fields will oblige by settling the point? Also inspection of the monitor pictures at Alexandra Palace shows that even good receivers do not do full justice to 405 lines. As regards brightness I have no criticism of television, for it can easily be adjusted to greater brightness than is desirable.

Though admiring Mr. Jeffery's loyalty to television, I do feel he is a little over-enthusiastic. In making a comparison it is assumed, of course, that the worst example of one system is not put by the side of an exceptionally good specimen of the other, but that the selections are typical. I also assume that the televisor is adjusted capably. When that has been done, often the results are very fine, technically and artistically—far more so than can possibly be judged from photographs of the screen—but at the best I think the definition is not as good as the cinema at its best; and a much larger (but diminishing) proportion of the programmes is open to technical criticism. Considering the long start that cinematography received, and the enormously greater resources accumulated, together with the ability to reject 95 per cent. of the film footage shot, it would be miraculous if it were not so. The fact that television can

Recent Inventions

Brief descriptions of the more interesting radio devices and improvements issued as patents will be included in this section.

TUNING FOR TELEVISION

WHEN the sound and picture channels of a television receiver are fed by the intermediate frequencies from a common heterodyne oscillator there is a tendency for the operator to use the local oscillator as a "volume control" for the sound.

In other words, the sound circuits are sometimes deliberately used in an out-of-tune condition. Although this may produce an acceptable volume of sound, the visual reproduction is likely to be poor, owing to the off-tune condition of the picture circuits.

In order to prevent such misuse of the set, the invention provides means whereby the channel for the picture signals is automatically put out of action until such time as the circuits handling the sound signals have been correctly tuned. For this purpose, a relay in the output of the sound receiver may be arranged to close a contact which brings the vision receiver into action, only when the signal reaches a maximum point, i.e., when the receiver is accurately tuned for sound.

Telefunken Ges. für drahtlose Telegraphie m.b.h. Convention date (Germany) November 3rd, 1936. No. 505031.

ELECTRON MULTIPLIER

THE Figure shows, in section, the arrangement of electrodes in a magnetically controlled valve in which secondary emission is employed to increase the effective amplification. A magnetic winding W surrounds the outside of the glass bulb B, and controls the electrons emitted from the primary cathode C so that they follow the curved paths shown in dotted lines.

The magnetic field is adjusted so that the electrons pass through slots in a pair of diaphragms D, D1, in a direction at right-angles to the main axis of the tube, and

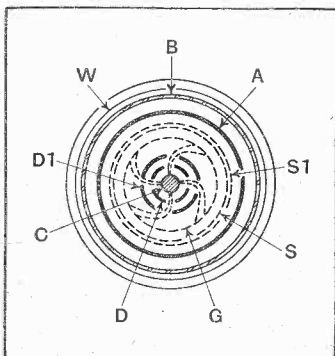

Sectional diagram of electrode arrangement in a magnetically controlled secondary-emission valve.

so that only electrons having practically equal velocities can get through. The outer surface of the

second diaphragm D1 then becomes the "effective cathode" so far as the other electrodes of the tube are concerned. From this point, the electron stream passes through a control grid G to two secondary-emission electrodes S, S1, which act as electron multipliers, before the stream finally reaches the output anode A.

Radio-Akt. D. S. Loewe. Convention date (Germany) October 14th, 1936. No. 505557.

Both the coils P, P1 and the resistances R, R1 are shunted by another pair of condensers to bypass HF currents.

Telefunken Ges. für drahtlose Telegraphie m.b.h. Convention date (Germany) November 14th, 1936. No. 505598.

LARGER PICTURES

INSTEAD of reproducing television pictures on a fluorescent screen mounted inside a cathode-ray tube, it would be an advantage to be able to project them on to a larger screen mounted outside the tube. One way of doing this is to replace the fluorescent screen by one built up of a great number of small "shutters," which are

then produces secondary emission, which builds-up charges on the shutters. The resulting lines of force react with the charge on the open-wire grid to swing the shutters to and fro to a degree which corresponds to the light and shade of the transmitted picture. In this way the transparency of the array of shutters is varied in the manner required to allow the lamp to project the picture on to the viewing screen.

Fernseh Akt. Convention date (Germany), 15th October, 1936. No. 503858.

OPEN-MESH ELECTRODES

AN "open" screen or electrode, such as is used to accelerate the electron stream in a cathode-ray tube, is made of a fabric, knitted from wire "threads" which may be of the order of five ten-thousandths of an inch thick. In this way it is possible to make the ratio of the

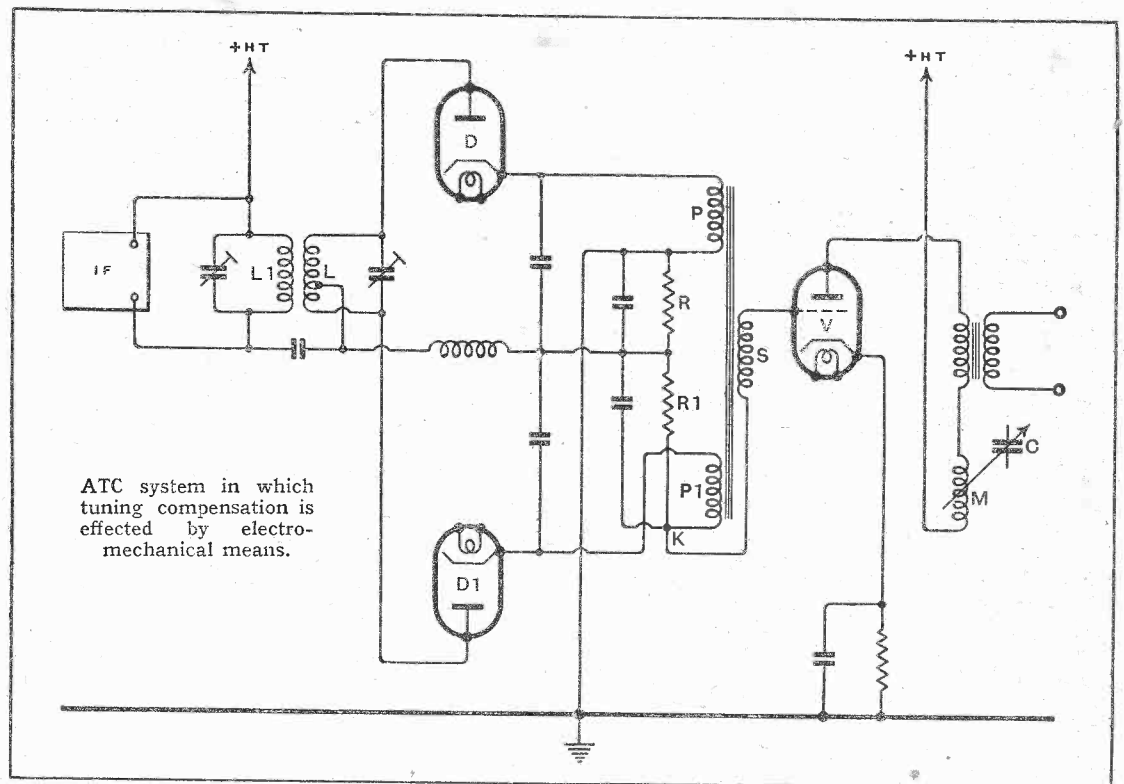

ATC system in which tuning compensation is effected by electro-mechanical means.

AUTOMATIC TUNING CONTROL

THE two differentially tuned circuits usually employed to develop the "control" voltage for ATC are replaced by the arrangement shown in the Figure, in which two rectifiers D, D1 are connected across one coil L of a band filter L, L1 in the output circuit of the IF stage of the receiver. The ATC voltage thus produced across the "balanced" load resistances R, R1 is fed from the point K to the grid of an amplifier V, and is then applied through a coil M to rotate a condenser C to correct for any initial mistuning.

At the same time, the rectified signal voltage is transformer-fed from the two primary coils P, P1 (the latter being reversed) to a secondary coil S in the grid circuit of the valve V. Since the two parts of the primary of the transformer are in series with the load resistances R, R1, the latter are short-circuited for the LF frequencies by the condensers shown.

then automatically opened or closed by the action of the scanning lamp so as to transmit more or less of the light from a powerful screen.

The difficulty is to find "shutters" which are sufficiently sensitive and rapid in their response to the fast-moving stream of electrons to give a clear-cut picture.

According to the invention, the electron stream falls on to a large number of pivoted shutters, made of small sheets of nickel coated at their lower ends. These are arranged to form a "mosaic" screen, which is backed by an open-wire grid. The impact of the scanning stream of electrons

aperture-area to the wire-surface anything between five to a hundred to one. In the latter case, practically all the electrons in the discharge stream can pass through on to the final projection screen, which is preferably of the incandescent type.

The same kind of mesh screen can also be used as the cathode-ray electron-emitting electrode in a discharge tube of the photoelectric type. In this case the "fabric" is oxidised and sensitised by caesium, after it has been mounted in position, and the image of a picture to be televised is projected on to it.

Farnsworth Television, Inc. Convention date (U.S.A.) October 31st, 1936. No. 503106.

The British abstracts published here are prepared with the permission of the Controller of H.M. Stationery Office, from Specifications obtainable at the Patent Office, 25, Southampton Buildings, London, W.C.2, price 1/- each.

CLASSIFIED ADVERTISEMENTS

NOTICES

THE CHARGE FOR ADVERTISEMENTS in these columns is

12 words or less, 3/- and 3d. for every additional word.

Each paragraph is charged separately and name and address must be counted.

SERIES DISCOUNTS are allowed to Trade Advertisers as follows on orders for consecutive insertions, provided a contract is placed in advance, and in the absence of fresh instructions the entire "copy" is repeated from the previous issue: 13 consecutive insertions 5%, 26 consecutive, 10%; 52 consecutive, 15%.

ADVERTISEMENTS for these columns are accepted up to **FIRST POST ON MONDAY MORNING** (previous to date of issue) at the Head Offices of "The Wireless World," Dorset House, Stamford Street, London, S.E.1, or on **SATURDAY MORNING** at the Branch Offices, 8-10, Corporation Street, Coventry; Guildhall Buildings, Navigation Street, Birmingham, 2; 260, Deansgate, Manchester, 3; 26s, Renfield Street, Glasgow, C.2.

Advertisements that arrive too late for a particular issue will automatically be inserted in the following issue unless accompanied by instructions to the contrary. All advertisements in this section must be strictly prepaid.

The proprietors retain the right to refuse or withdraw advertisements at their discretion.

Postal Orders and Cheques sent in payment for advertisements should be made payable to **ILIFFE & SONS Ltd., and crossed & Co.** Notes being untraceable if lost in transit should not be sent as remittances.

All letters relating to advertisements should quote the number which is printed at the end of each advertisement and the date of the issue in which it appeared.

The proprietors are not responsible for clerical or printers' errors, although every care is taken to avoid mistakes.

NUMBERED ADDRESSES

For the convenience of private advertisers, letters may be addressed to numbers at "The Wireless World" Office. When this is desired, the sum of 6d. to defray the cost of registration and to cover postage on replies must be added to the advertisement charge, which must include the words Box 000, c/o "The Wireless World." All replies should be addressed to the Box number shown in the advertisement, c/o "The Wireless World," Dorset House, Stamford Street, London, S.E.1. Readers who reply to Box No. advertisements are warned against sending remittances through the post except in registered envelopes; in all such cases the use of the Deposit System is recommended, and the envelope should be clearly marked "Deposit Department."

DEPOSIT SYSTEM

Readers who hesitate to send money to advertisers in these columns may deal in perfect safety by availing themselves of our Deposit System. If the money be deposited with "The Wireless World," both parties are advised of its receipt.

The time allowed for decision is three days, counting from receipt of goods, after which period, if buyer decides not to retain goods, they must be returned to sender. If a sale is effected, buyer instructs us to remit amount to seller, but if not, seller instructs us to return amount to depositor. Carriage is paid by the buyer, but in the event of no sale, and subject to there being no different arrangement between buyer and seller, each pays carriage one way. The seller takes the risk of loss or damage in transit, for which we take no responsibility. For all transactions up to £10, a deposit fee of 1/- is charged; on transactions over £10 and under £50, the fee is 2/6; over £50, 5/-. All deposit matters are dealt with at Dorset House, Stamford Street, London, S.E.1, and cheques and money orders should be made payable to Iliffe & Sons Limited.

SPECIAL NOTE.—Readers who reply to advertisements and receive no answer to their enquiries are requested to regard the silence as an indication that the goods advertised have already been disposed of. Advertisers often receive so many enquiries that it is quite impossible to reply to each one by post. When sending remittances direct to an advertiser, stamp for return should also be included for use in the event of the application proving unsuccessful.

PREMIER RADIO STOCKTAKING SALE FINAL SALE OFFERS!

- BATTERY CHARGERS** for A.C. Mains, 2 volts, 1/2 amp. Metal Rectification, 10/-.
- POTENTIOMETERS WITH SWITCH**, 1/2 meg., 1 meg., 20,000 ohms and 10,000 ohms, 1/3 each.
- POTENTIOMETERS WITHOUT SWITCH**, 2 meg., 1 meg., 1/2 meg., 400,000 ohms, 25,000 ohms, 20,000 ohms, 10,000 ohms, 1/- each.
- SPECIAL OFFER—CONTINENTAL MAINS VALVES**, 4 v. AC Types, 5-pin only, AC/HL, AC/L, AC/P, AC/SG, AC/VMS, AC/HP, AC/VHP, 2/6 each.
- F.W. RECTIFIERS** 350v. 120ma., 4/6; 500v. 120 ma., 5/6.
- 20 v. 18a AC/DC Types**, SG. Var. Mu., SG. Power, HF Pen., 2/- each.
- U.S.A. Types**, 24, 30, 41, 39/44, 35/51, 55, 56, 57, 58, 71, 77, 78, 85, 2A5, 2A6, 2A7, 2B7, 6A7, 12Z3, 210, 250, all 2 for 3/-.
- TUBULAR CONDENSERS**, .002, .0001, .0003 and .0005 mfd., 1/- doz. Your choice.
- ELECTROLYTIC CONDENSERS**. Metal Can. 8 mf. 320 volts, 2 for 1/6. 8+8 mf. 475 v.-10 mf. 50 v., 2 for 2/6. 8+8 mf. 450 v.+8 mf. 250 v., 2 for 2/6.
- T.C.G. DRY ELECTROLYTICS**. 8+8+4 mf. 500 v. 2/- each.
- 500 v. CARDBOARD ELECTROLYTICS**. 4 mf. or 8 mf. 1/6. 8+4 mf., 2/9. 8+8 mf., 2/6. 4+4 mf., 2/4.
- MAINS TRANSFORMERS — MANUFACTURERS' SURPLUS**. 250—250 v. 60 ma., 4 v. 2 a., 13 v. 1 a., 3/6.
- GARRARD AUTO CHANGERS**, Model RC.4 for A.C. Mains, 250-250 v., plays eight 10" or 12" Records. Limited quantity only to clear at **£5.50**.

NOW READY
PREMIER 1940 CATALOGUE
 112 illustrated pages. Over 20 pages of British and American Valve Data. Bigger and Better than Ever!
GET YOUR COPY NOW. Price 6d.
Huge Reduction in Prices of TRIAD U.S.A. VALVES
 from 2/3 each!

PREMIER SHORT-WAVE KITS.
 Complete to the last detail including all Valves and coils, as well as theoretical and wiring diagrams and lucid instructions for building and working. Each kit is supplied with a steel Chassis and Panel and uses plug-in coils to tune from 13 to 170 metres.

- 1 Valve Short-Wave Receiver or Adapter Kit ... 17/6
- 1 Valve Short-Wave Superhet Converter Kit ... 20/-
- 1 Valve Short-Wave A.C. Superhet Converter Kit ... 22/6
- 2 Valve Short-Wave Receiver Kit ... 25/-
- 3 Valve Short-Wave Screen Grid and Pentode Kit ... 58/6

PREMIER U.S.A. QUARTZ TRANSMITTING CRYSTALS
 7 mc Band, 10/- each, with Calibration Certificate. Enclosed holder and base, 3/-.

MORSE KEYS. Excellent brass movement on bakelite base, 2/9 each.

PREMIER SHORT-WAVE COILS, 4- and 6-pin types, 13-26, 22-47, 41-94, 78-170 metres, 1/9 each, with circuit. Special set of S.W. Coils, 14-150 metres, 4/- set, with circuit. Premier 3-band S.W. coil, 11-25, 19-43, 38-86 metres. Suitable any type circuit, 2/6.

UTILITY Micro Cursor Dials, Direct and 100:1 Ratios, 3/9.

PREMIER Short-Wave Condensers, all-brass construction, with Trolitol insulation. 15 mmf., 1/6; 25 mmf., 1/7; 40 mmf., 1/9; 100 mmf., 2/-; 160 mmf., 2/3; 250 mmf., 2/6.

TROLITOL DOUBLE SPACED TRANSMITTING CONDENSERS. 15 mmf., 2/9; 40 mmf., 3/6; 100 mmf., 4/-; 160 mmf., 4/6.

COIL FORMERS, 4- or 6-pin low-loss, 1/- each. Orders 5/- and over sent Post Free. Under 5/- please add 6d. Postage.

"CLASS B" KITS, comprising driver transformer, 2 volt Class B Valve and holder, with circuit. 10/- complete.

MAGNAVOX 8" P.M. MOVING COIL SPEAKERS, with Output Transformer, 10/6 each.

ALL POST ORDERS TO: Jubilee Works, 167, Lower Clapton Road, London, E.5. Amherst 4723.
CALLERS TO: Jubilee Works, or our NEW PREMISES, 169, FLEET STREET, E.C.4. Central 2833.
 or 50, High Street, Clapham, S.W.4. Macaulay 2381

For details of the NEW 1940 RANGE of
ARMSTRONG CHASSIS
 See AUGUST 17th "Wireless World"
SOMETHING REALLY GOOD
 Look out for it!
ARMSTRONG MANUFACTURING CO.
 Warlers Road, Holloway, London, N.7.
 Phone: NORTH 3213

NEW RECEIVERS AND AMPLIFIERS

*** CHALLENGER RADIO CORPORATION "Degallier's."**
 Send 2d. stamp for handsome illustrated catalogues telling of our superb range of 1940 fully guaranteed receivers; direct to public sales policy saves you 40%; sets to suit every pocket from 65/- to £31/10. Sale list also available upon request.—Challenger Radio Corporation, "Degallier's," 31, Craven Terrace, London, W.2. Paddington 6492. Nearest point, Lancaster Gate Tube. [8751]

RADIO CLEARANCE, Ltd., 63, High Holborn, London, W.C.1. Phone: Holborn 4631.

GUTHNAN MCMURDO Silver Super Silver Communication Receiver.
 Described in Previous Issue of This Magazine. Circuit, superhet, double regeneration obtained at signal frequency and also at intermediate frequency, as a result very high sensitivity and selectivity are obtained; controls include R. meter, silencer, tone, aerial trimmer, A.F. gain selectivity, beat oscillator, receive-send, A.V.C., B.F.O., on-off, B.F.O. pitch, assembled with valves but unwired, £17; wired and aerial tested, £18/18. **AMAZING Offer for One Month Only.**

BRITISH Belmont 9-valve A.C. Superhet Chassis, complete with Mullard valves, four wave bands, covering 6-2,000 metres, complete with escutcheon and all necessary parts for fixing into cabinet, £57/6 each; complete in De Luxe cabinet with speaker, £77/7; speaker matched for use with above chassis available at 15/- each extra.

RADIO CLEARANCE, Ltd., 63, High Holborn, London, W.C.1. Phone: Holborn 4631. [8786]

AMAZING Offer.—Famous 7-valve push button 1939 models in makers sealed cartons, issued 15 1/2 gns.; £5/19/6; list free.—Shippers, 18, Corporation St., Manchester. [0639]

ARMSTRONG Co.—After many years at our old premises at Camden Town we have removed to a new building in Warlers Rd., Holloway, N.7 (see displayed advertisement).

ARMSTRONG Amplifier Division Has Removed to New Premises at 94, Camden Rd., N.W.1. In addition to our standard range of 6- and 12-watt push-pull high fidelity amplifiers and local station feeder units, we manufacture equipment for special purposes, pre-stage units, electronic mixers, tone control units, etc.

ARMSTRONG Are Always Pleased to Assist in the Solution of Special Problems; details of standard equipment free on request.

ARMSTRONG Co. (Amplifier Division), 94, Camden Rd., N.W.1. [8752]

USED SETS FOR SALE HALLICRAFTER

HALLICRAFTER Sky Chief, slightly used, £6.—Box 697, c/o The Wireless World. [8779]

1939 Sky Champion, with "S" Meter (Hallicrafter), £14/14, or near offer.—22, Clifton Ave., Walthamstow. [8783]

CAR RADIO

ALL Goods Previously Advertised Still Available.
HENRYS, 72, Wellington Ave., Stamford Hill, N.15. Stamford Hill 2907. [8745]
1939 Models from 4 1/2 gns., 6 new car aerials, from 9/6; trade enquiries solicited; lists free.—Shippers, 18, Corporation St., Manchester. [0622]

PUBLIC ADDRESS

VORTEXION P.A. Equipment.
IMITATED, but unequalled.
WE Invite You to a Demonstration.
A.C.-D.C. Dance Band Amplifier, 10 watts output, complete in case, with moving coil microphone, speaker and cables, weight 22lb.; 12 gns.
A.C.-20 15-20 watt Amplifier, 38-18,000 cycles, independent mike and gram, inputs and controls, 0.037 volts required to full load, output for 4 7.5, and 15 ohms speakers or to specification inaudible hum level, ready for use; 8 1/2 gns., complete.
C.P. 20 12-volt battery and A.C. Mains Model, as used by R.A.F. output as above; 12 gns.
A.C. 20 in portable case with Collard motor, Piezo pick-up, etc., £14; C.P.20 ditto, £17/17.
50-WATT Output 6L6s, under 60-watt conditions, with negative feed back, separate rectifiers for anode screen and bias; with better than 4% regulation level response, 20-25,000 cycles, excellent driver, driver transformer, and output transformer matching 2-30 ohms impedance electronic mixing for mike and pick-up with tone control, complete with valve and plugs; £15.
COMPLETE in Case, with turntable, B.T.H. Piezo pick-up and shielded microphone transformer; £20.
80-WATT Model, with negative feed back; £25, complete.
120-WATT Model, with negative feed back; £40, complete.
250-VOLT 250 m.a. Full Wave Speaker field supply unit; 25/-, with valve.
ALL P.A. Accessories in Stock, trade supplied.

VORTEXION, Ltd., 182, The Broadway, Wimbledon, S.W.19. Phone: Lib. 2814. [8241]

GIVING UP: P.A. amplifiers, speakers, microphones, converters, etc. for sale; send for list.—Straw, 9, St. John's St., Colchester. [8776]

"PARTRIDGE P.A. Manual," free to trade, from N. Partridge, B.Sc., A.M.I.E.E., King's Buildings, Dean Stanley St., London, S.W.1. [0631]

AMPLIFYING Equipment, P.A. vans for sale or hire. Booklet on request.—Alexander Black, Ltd., 55, Ebury St., S.W.1. Sloane 6129. [0599]

PUBLIC Address Contractors Can Hire P.A. Vans, loud speakers, microphones and equipments of all types from Hire Dept., Gramphon Reproducers, Ltd., Kew Gardens, Surrey. Tel.: Richmond 1175-67. [0618]

NEW MAINS EQUIPMENT

VORTEXION Mains Transformers, chokes, etc., are supplied to G.P.O., B.B.C., L.P.T.B. Why not you? VORTEXION, Ltd., 182, The Broadway, Wimbledon, London, S.W.19. Telephone: Liberty 2814. [8772]

NEW LOUD-SPEAKERS

SINCLAIR Speakers for All Types.—Puteney Terrace, Copenhagen St., N.1. [0603]

BAKERS New Corner Horn Speakers, Triple cone conversions; from 29/6, and surplus speaker bargains.—Bakers Selhurst Radio, 75, Sussex Rd., South Croydon. [8728]

LOUD-SPEAKERS

SECOND-HAND, CLEARANCE, SURPLUS, ETC.

3,000 Speakers from 5/6 each, P.M. and energised 4in. to 14in., including several Epoch 18in.—Sinclair Speakers, Puteney Terrace, Copenhagen St., N.1. [0591]

TELEVISION

H.M.V. 29 Gns. All-wave Receiver, as new; £20.

HENRYS, 72, Wellington Ave., Stamford Hill, N.15. Stamford Hill 2907. [8746]

WANTED Immediately.—Baird grid cell type Kerr cells complete with polarising prisms, full price paid for unit in perfect condition.—Physical Laboratory, The University, Aberdeen. [8787]

TRANSMITTING APPARATUS

NATIONAL N.C. 100, complete, almost new; Hammerlund H.Q. 120X, new, unused; best offer.—T. Pater-son, 25, High St., Carlisle, Lanarkshire. [8784]

A.C.S. RADIO, specialists in short wave apparatus, communication receivers, including Hallicrafters, National and R.M.E., transmitting equipment, valves and components. Send for free catalogue to A.C.S. Radio, 16, Gray's Inn Rd., W.C.1. Holborn 9894.5. G2NK, Technical Manager. [0550]

G5N1.—The oldest and largest distributor of amateur equipment, transmitting and receiving; short-wave catalogue, 15d. G5N1 70-page Manual, 75d., post free; authorised direct distributor for Collins, National, R.M.E., Thorndarson, Hammerlund, Biley, Taylor, Elmec, etc., etc.—44, Holloway Head, Birmingham. [0531]

CABINETS

A CABINET for Every Radio Purpose.

CONVERT Your Set into a Radiogram at Minimum Cost; surplus cabinets from noted makers under cost of manufacture (undrilled); 30/- upwards; motors at wholesale prices.

"FIT-A-GRAM" Cabinet, 31x17x15; 21/-.

UNDRILED Table Console and Loud-Speaker Cabinets from 3/6.

INSPECTION Invited; photos loaned to country customers.

H. L. SMITH and Co., Ltd., 289, Edgware Rd., W.2. Tel.: Pad. 5891. [0485]

DYNAMOS, MOTORS, ETC.

ALL Types of Rotary Converters, electric motors, battery chargers, petrol-electric generator sets, etc., in stock, new and second-hand.

A.C.-D.C. Conversion Units for Operating D.C. Receivers from A.C. Mains, 100 watts output, £2/10; 150 watts output, £3/10.

WARD, 46, Farringdon St., London, E.C.4. Tel.: Holborn 9703. [0518]

ELECTRADIX Rotary Converters for A.C. Radios on D.C. Mains; alternators 50 to 500 cycles; mains motors and motor generators for 1 to 600 cells; petrol engines and switchgear.—218, Upper Thames St., London, E.C.4. [0619]

RECORDING EQUIPMENT

ALL Recording Discs and Materials in Stock, tracker units, £4/7/6; recording motors, £3/17/6.—Write for further details, Will Day, Ltd., 19, Lisle St., W.C.2. [0595]

VALVES

ALL Types of American Tubes in Stock of Impex and Arcturus makes at competitive prices.

WE Can Also Supply a Full Range of Guaranteed Replacement Valves for Any British non-ring, American or Continental type at an appreciably lower price.

SEND for Lists of These, and also electrolytic condensers, line cords, resistances, etc.

CHAS. F. WARD, 46, Farringdon St., London, E.C.4. Tel.: Holborn 9703. [0452]

AMERICAN, 2/9; 1,000 non-ring British from 1/9; bargains galore; lists free.—Shippers, 18, Corporation St., Manchester. [0607]

METROPOLITAN RADIO SERVICE.—Special offer, American valves, in makers' cartons, 3/- each, Octals, 3/6 each; American valves, first grade, in all types; trade supplied.—1021, Finchley Rd., N.W.11. Speedwell 3000. [0436]

ELECTRICAL EQUIPMENT

1- and 3-phase Motors, 1/4 to 5 h.p., surplus stock, first class condition.—Tel.: Reliance 1693. Esaco Electrical Service, 18, Brixton Rd., S.W.9. [0642]

COMPONENTS

SECOND-HAND, CLEARANCE, SURPLUS, ETC.

PREMIER SUPPLY STORES.

PLEASE See Our Displayed Advertisement on page 2. [0488]

GOODS Previously Advertised Still Available.—Ryall's Radio, 280, High Holborn, London, W.C.1. [8709]

ELECTRADIX

REDECORATION SALE OF CHARGERS, ETC.

RECTIFIERS AND CHARGERS FOR A.C. MAINS, 230 volts 5 kW. Rectifier, Philips, valve, D.C. output 230 volts, tapped transformer, £12. A.C. CHARGERS, DAVENSET, Type G.C. Wall Garage Charger, 25 volts 6 amps, 3 circuit 40 cells at once, £6 10s. Type H.T.S. Steel cased, bench type, for 130 cells at 1, 2, and 3 amps, £14 10s. Type A.S.G.4. Steel cased, 4 circuit with indicators, automatics and regulators for 80 cells, £14 10s. 230 volts PHILIPS' "Three-in-One" No. 1087 single circuit, 24 volts 10 amps, Steel case, bench type, £7 10s. 230 volts E.H.I. Tungar Chargers, 75 volts 10 amps, 2 circuits, rheo, and tap controls, £12 15s. H.T. Tungar for output D.C., 120 volts amp, £6 10s. 230 volts WESTINGHOUSE single circuit, K type, 40 volts 3 amps, £7 10s. Westinghouse Wall Charger, 15 volts 6 amps, for car batteries, £6 18s.

D.C. CHARGERS. Davenset D.C.2. Steel cased, bench type, 2 circuits and meters, wheel rheos, 230 volts 1 and 3 amps, £5 10s. METAL RECTIFIERS AND CHARGERS. Westinghouse Wall type "R" Steel case, 12in. by 19in. for 200-230 volts A.C. mains to 40 volts 3 amps. D.C. for 40 Radio Cells. Guaranteed, £7 7s. 6d. Similar one for Car Battery Charging, 15 volts 6 amps, D.C. output, £6 17s. 6d. Fine model also for A.C. mains with D.C. output of 230 volts 250 m.a., £7 2s. 6d. Two 50-volt circuits each of 750 m.a. D.C. from A.C. mains is another bargain at £6 10s. All these are in new condition. "NITNDAY" CHARGERS. For any mains voltage between 100 to 250 volts A.C. All steel chassis, H.M.V. Transformers, Westinghouse Rectifiers.

Model N/A 6/8 volts 4 amp. Car Trickle Charger, 15V. Model N/B 6/8 volts 1 amp. Car Charger, 25V. Model N/B11 6 volts 11 amp. Car Charger, 25V. Model N/C 6/8 volts 2 amp. Car Charger, 38V. Model N/D 12/15 volts 1 amp. Car Charger, 32V. Model N/D 12/15 volts 1 amp. Car Charger, 55V. Model N/E 2 Doubler 6/8 volts and 12/15 volts 2 amps. Titled ammeter, Super Car Charger, 65V. A.C. ROTARY CHARGERS. 3 phase Motor 200 volts to D.C. Dynamo 8 volts 15 amps, £4 17s. 6d. R.C.A. 3 ph. Motor 220 volts coupled to D.C. Dynamo 500 volts 200 m.a., £5 10s. Metvick 3 ph. 1 h.p. Motor coupled to D.C. Dynamo 120 volts 30 amps, £6. Single phase to D.C., Higgs 230 volt A.C. Motor coupled to D.C. Dynamo 8 volts 15 amps, £7 10s.

D.C. ROTARY CHARGERS. 3 h.p. 220 volt D.C. Motor 6 volt 250 amp. Dynamo, £16. 200 volt Motor 25 volts 8 amps. dynamo, £4. Motor 220 volts 8 volts 50 amps. dynamo, £6 10s. And others up to 6 kW. 300 CELL A.C./D.C. CRYPTO MOTOR-GEN. SET. For 220 v. A.C. mains. For Radio Cell Circuits and ten 12-volt 10 amp. Car Batts. D.C. output 160 volts 20 amps. Sale, £32. CHARGING DYNAMOS. 6 volts 3 amps., Type R, 25V.; 12 volts 10 amps., Type C, 35V.; 16 volts 30 amps., Type TB, 50V.. Kindly state your wants and we will send list of suitable gear. STATIC CONVERTERS. A.C. to D.C. 40 watts output, steel cased. Input 230 volts A.C. 50 cycles, output 440 volts 60/100 m.a. D.C. with valves, 45V. A.C. mains to D.C. 120 watts at 4 amp. CHARGING METERS, central zero, charge and discharge in all switchboard sizes, from 2in. dial up to 15 amps, 7/6, to 8in. dial switchboard meters. D.C. GENERATORS.—Shunt wound—110 volts 1 amp., 15V.; 200 volts 1 amp., 17/6.; 200 volts 1 1/2 amp., 26/-. LUCAS AERO, 9/12 volts, 120 watts D.C., enclosed, 4,000 revs. As used on Aircraft wireless. Cost £15. Reduced Sale Price, 12/6. DYNAMO H.T. DUAL, 600 volts for H.T., 100 m.a. and L.T. 6 volts 5 amps. Reduced Sale Price, 15/-.

Send for Special Sale List "W."

ELECTRADIX RADIOS

218, UPPER THAMES STREET, LONDON, E.C.4 Telephone: Central 4611

GET 2 YEARS FREEDOM FROM NEEDLE CHANGING

with the GENUINE Walco Sapphire GRAMOPHONE NEEDLES

More than 2,000 playings from one needle, a minimum of record wear, and greatly improved reproduction are obtained from the new Walco Needle—price 12/-. Order now or write for FREE BOOKLET "SOUND REPRODUCTION" from

R.A. Rothermel (Dept. G) Canterbury Road, High Road, Kilburn, N.W.6

ENGINEERS! ARE YOU EARNING LESS THAN £10 PER WEEK? If so, you cannot afford to carry on without reading our 268-page Handbook. The book explains clearly and definitely many ways of carving out a successful career. Among other things it explains the Services of our unique Appointments Department; outlines Home-Study Courses in all branches of Civil, Mechanical, Electrical, Motor, Aero, Wireless, "Talkie" Engineering, Building, Govt. Employment, etc., and gives details of B.Sc., A.M.I.C.E., A.M.I.E.E., A.M.I.Mech.E., A.M.I.A.E., A.M.I.W.T., A.M.I.R.E., G.P.O., METRIC, and all Exams. We Guarantee "NO PASS—NO FEE." Whether you be an old hand or a budding apprentice get this book to-day. FREE and POST FREE. BRITISH INSTITUTE OF ENGINEERING TECHNOLOGY. 367, Shakespeare House, 17/19, Stratford Place, London, W.1.

COMPONENTS—SECOND-HAND CLEARANCE, SURPLUS, ETC.

R. RADIO CLEARANCE, Ltd. 63, High Holborn, W.C.1. Phone: Holborn 4631.

FULLMENT Transformers.—In-put 200-250 volt, out-put 2 volt 4 amp.—4 volt 6 amps., 4/11 each. MAINS Transformers.—American windings. In-put 200-250 volt, tapped. Out-put 350-0.350. 100 m.a. 5 volt 2 amp. 6.3 volt 5 amp.; 7/11 each.

G.E.C. Mains Transformers.—American windings. 350-0.350 volt. 65 m.a. 5 volt. 2 amp. 6.3 volt. 2.5 amps.; suitable for replacements in G.E.C. models; 5/6 each.

AUTO Transformers.—100-230 volt; 5/11. ELECTROLYTIC Condensers.

PLESSEY 8x4x4x4x4 mfd. 570 volt working; 2/- each.

PLESSEY 24 mfd. Can type electrolytics, 450 volt working; 10d. each.

T.C.C. 8 mid. Can type Wet Electrolytics, 450 volt working; 1/3 each.

PLESSEY Electrolytic Condensers, 8x8 mfd., 450 volt working; 1/- each.

POLAR N.S.F. Resistances.—1 gross parcels of 1/2 and 1/3 watt resistances, all good sizes, our selection; 4/6 each.

PRESS Button Units, with 6 press buttons ready for wiring into set, with circuit; 6/11 each.

BULGIN.—20,000 ohms wire wound pots; 1/- each.

STRANDED Push Back Wire; 1d. yd., 12 yds., 10d.

YAXLEY Switches.—2 pole, 4 way, 3 bank; 1/6 each.

YAXLEY Switches.—2 pole, 5 way, 4 bank; 2/- each.

AMERICAN Chassis Mounting Valve Holders.—4, 5, 6 and 7 pin; 3d. each.

OCTAL Chassis Mounting Valve Holders.—4d. each.

7-Pin English Type Valve Holders. Chassis mounting; 2d. each.

RAYTHEON 76 Valves; 1/6 each.

FULL Range of Raytheon Valves in Stock.—Most competitive prices: For example:—

80—2/9 each.

43—4/- each.

6D6—4/- each.

6C6—4/- each, etc.

SEND for Complete Price List of Raytheon Valves.

SET of Three Manufacturers' Type All-wave Coils, 13-2000 metres, including oscillator, aerial and H.F., with three-gang straight condenser, 2/6 each; wave change switch for above, 2/- each.

ROTHERMEL Piezo Crystal Speakers.—7 1/2 in. cone; list 55/-, our price, 9/6 each.

RADIO Clearance, Ltd., 63, High Holborn, London, W.C.1. Telephone: Holborn 4631.

ALL orders over 5/- carriage free; under this amount, sufficient postage must be included with order.

ALL Enquiries Must Enclose 1/2d. stamp. [8785]

VAUXHALL.—All goods as previously advertised still available; write for free list.—Vauxhall Utilities, 163a, Strand, W.C.2. [8727]

SOUTHERN RADIO, 46, Lisle St., London, W.C. Ger-rard 6553. Stocks of receivers and replacement components, as previously advertised. [8548]

MAINS RADIO DEVELOPMENT COMPANY Offer Immediate Carriage Paid Delivery, call mornings. Telephone Tudor 4046. Stamp for List 22s.

MICA Tag Condensers, 0.0001 to 0.002 T.C.C., Ormond, etc., six different sizes in each parcel of twelve for 1/-; thirty for 2/-.

ERIE One-watt, colour coded, unused resistors, any size, 50 ohms to 5 megohms, your selection, 3d., 2/6 dozen; two-watt, 6d.

CENTRALAB Latest Potentiometers, long standard spindle, unused, all sizes, 5,000 ohms to 2 megohms, 2/-; with switch, 2/3.

TUBULAR Cncondensers, 400v. working, wire ends, best make, 0.0001-0.05 mfd., 4d.; 0.1 mfd., 4d.; 0.25, 0.5 mfd., 6d.

CLIX Unused Chassis Valve-holders, 5-pin, 7-pin, 3d.; American sizes, 6d.; best sleeve, 1/2d. yard.

FIFTY Unused N.S.F. 1/2, 1, 2 watt resistors, wire ends, marked and colour coded, 20 different useful sizes in each parcel; 50 for 2/6.

MAINS RADIO DEVELOPMENT COMPANY, 4-6, Muswell Hill Rd., London, N.6. Tudor 4046. [8778]

METAL Case Paper Condensers:—1,000-volt wkg. 8mfd. 9/6 each, 4mfd. 5/- each, 2mfd. 3/- each; 800-volt wkg. 8mfd. 4/- each, 2mfd. 2/6 each, 1mfd. 1/9 each; 500-volt wkg. 4mfd. 3/- each, 2mfd. 1/9 each, 1mfd. 1/6 each; 400-volt wkg. 4mfd. 1/9 each, 2mfd. 1/3 each.

BAKELITE Tubulars:—800-volt wkg. 0.5mfd. 9d., 0.25mfd. 6d., 0.1mfd. 4d., 0.05mfd. 3d.; 400-volt wkg. 1.0mfd. 6d., 0.5mfd. 4d., 0.1mfd. 2d.

ELECTROLYTIC Dry Blocks:—500 p.v. 32+8mfd. 3/9 each, 32mfd. 3/3 each, 16mfd. 2/- each, 8+8mfd. 2/9 each, 8+4mfd. 2/3 each, 8mfd. 1/6 each, 4mfd. 1/3 each.

ELECTROLYTIC Tubulars:—50mfd. 50 p.v. 1/3 each, 25mfd. 25 p.v. 9d. each; aluminium can 8+8mfd. 500 p.v. 4 leads 2/- each.

SUPPRESSOR Condensers:—0.1+0.1mfd. 400-volt wkg. tubular, with wire leads, 1/- each; 0.5mfd. in metal case with lead, 1/8 each; 4+4mfd. centre tapped unit with fuses, 10/6; post 6d. or c.o.d.—The Static Condenser Co., 387a, King St., Hammersmith, London, W.6. [8777]

REPAIRS AND SERVICE

"SERVICE with a Smile." AMERICAN Valves, spares, linecords, rewinds, repairers of all types of American and British receivers.—E.R.I., Ltd., 22, Howland St., W.1. Museum 5675. [0434] LOUD-SPEAKER Repairs, British, American, any make, 24-hours' service; moderate prices.—Sinclair Speakers, Puteney Terrace, Copenhagen St., N.1. [0590]

—Third Edition of

WIRELESS DIRECTION FINDING

BY R. KEEN, B.Eng.

A BOOK OF INSTRUCTION AND REFERENCE FOR ENGINEERS, TECHNICIANS, TELEGRAPHISTS AND OTHERS ENGAGED OR INTERESTED IN THE USE OF DIRECTIVE WIRELESS TELEGRAPHY FOR THE NAVIGATION OF SHIPS AND AIRCRAFT

The third edition of this well-known book deals with the principles of Wireless Direction Finding and gives an account of the circuits and apparatus used in its application to navigation. The Adcock Aerial has a separate chapter covering its principles together with much information on its installation and performance. Further chapters are included on Shore, Ship and Aircraft installations as well as a special section on the choice of a suitable site for the Aircraft Ground D.F., with Adcock Aerials.

Engineering students and research engineers will find useful references to a selected list of some 600 of the more important contributions to the literature of D.F.

800 pages

550 illustrations

PRICE 25/- net

By post 25/9

From leading Booksellers or direct from the Publishers:

LILIFFE & SONS LTD., DORSET HOUSE, STAMFORD STREET, LONDON, S.E.1

THIRD Edition of

*The Autocar***GUIDE for the
L DRIVER***is now available*

Explains in simple language, with clearly designed diagrams and illustrations, precisely what the beginner must be able to do in order to pass as a fully qualified driver.

1/- net By post 1'2

*From Booksellers and Bookstalls or direct from the Publishers:*LILIFFE & SONS LTD.,
DORSET HOUSE, STAMFORD STREET, LONDON, S.E.1

Second Edition—

**RADIO DATA
CHARTS**

A SERIES OF ABACS
providing most of the essential
Data required in Receiver Design.

By R. T. BEATTY, M.A., B.E., D.Sc.

Published from the Offices of
"THE WIRELESS WORLD"

"Radio Data Charts" provide designers of wireless apparatus with a ready and convenient means of solving problems without having recourse to complicated formulæ and mathematics.

By the use of "Radio Data Charts" such abstruse problems as the design of tuning coils are solved almost as easily as the simple application of Ohm's Law.

Price 4/6 net

By post 4/10

*From leading booksellers or direct from the publishers*LILIFFE & SONS LTD.
Dorset House, Stamford Street, London, S.E.1
W.W.93

DAILY SKETCH

FOR
INSIDE INFORMATION

ON

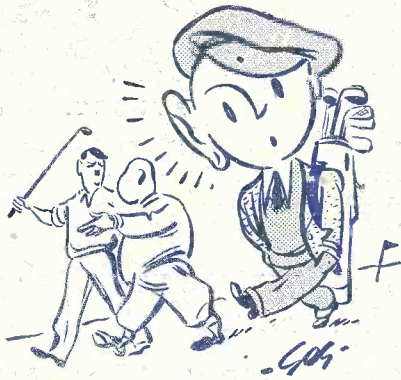

FOREIGN AFFAIRS

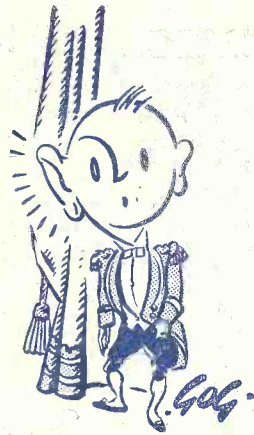

SOCIETY

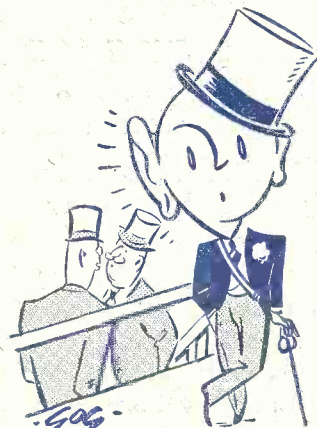

THE TURF

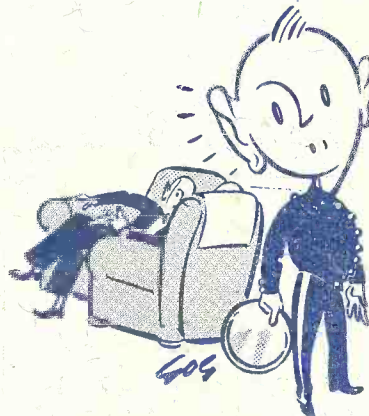

CLUB LIFE

THE DAILY SKETCH IS EASILY FIRST

The Wireless ^{6^D} World

THE PRACTICAL RADIO & TELEVISION JOURNAL

Thursday, August 17th, 1939.

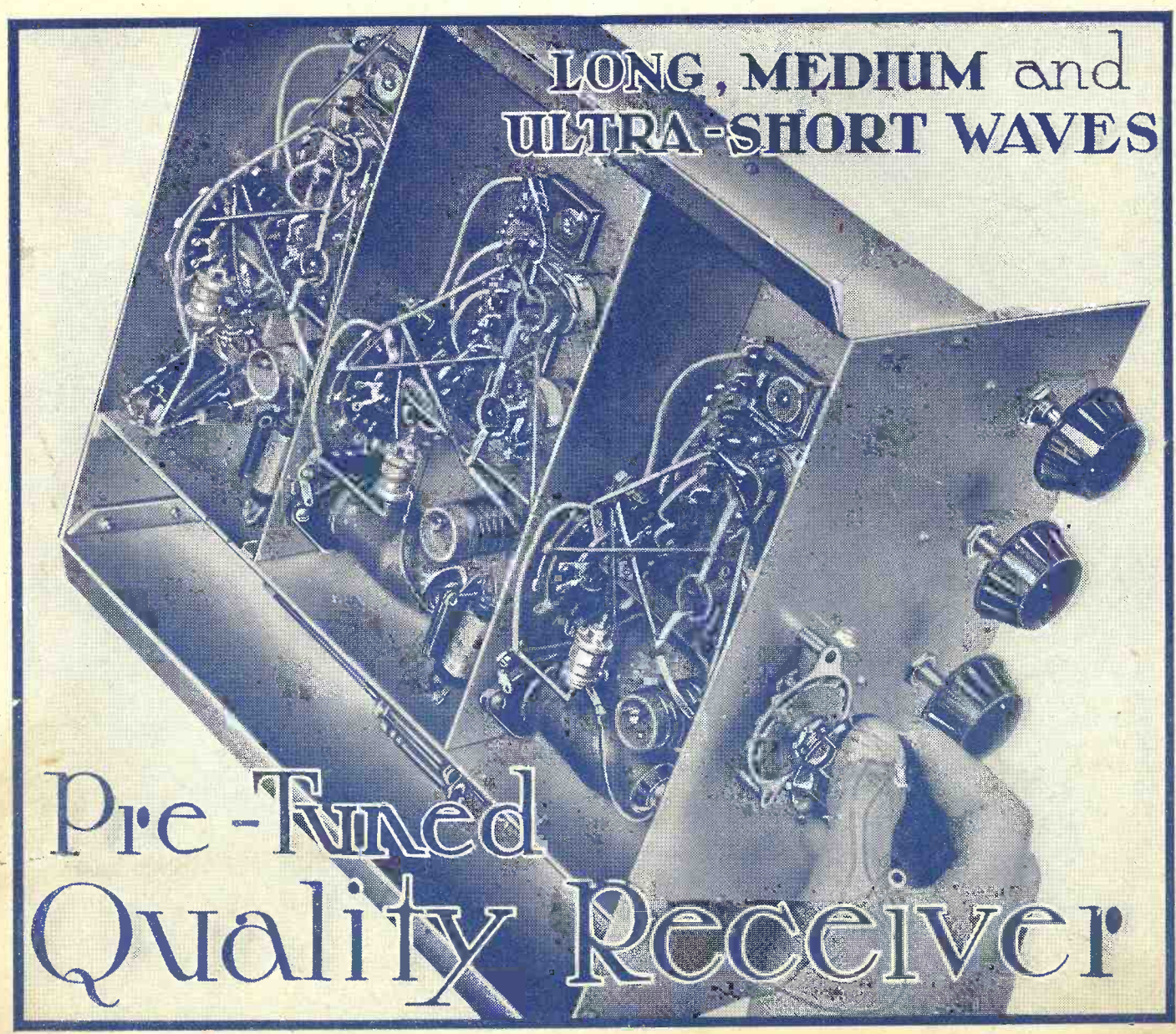

THERMIONIC MEASURING APPARATUS FOR MANY PURPOSES

THERMIONIC TEST SET

A UNIQUE INSTRUMENT OF REMARKABLE CAPABILITIES

Measures

A.C. ————— D.C.

<p>CURRENT: ·005 microamps to 5 amperes.</p> <p>VOLTAGE: 50 millivolts to 500 volts on frequencies from 25 to 20,000,000 cycles.</p>	<p>CURRENT: ·0005 microamps to 1 ampere.</p> <p>VOLTAGE: 1 millivolt to 500 volts.</p>
--	--

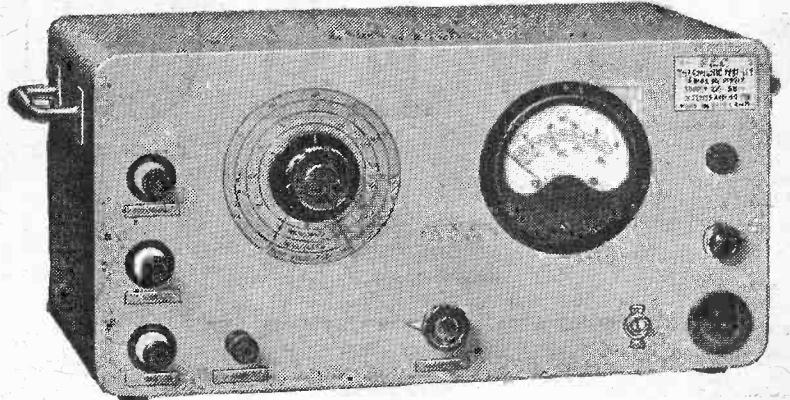

(Patent Applied for)

PRICES: A.C. Model ... £46-15-0
Battery Model ... £42-18-0

This is an entirely new direct reading instrument operating on the Valve Voltmeter system for the measurement of A.C. or D.C. voltage and current.

A patented circuit of the D.C. amplifier type using negative feedback is employed with a potentiometer input. The instrument can be supplied for either battery or mains operation, and may be used on D.C. or A.C. up to 20 megacycles per second. The impedance of the instrument on D.C. and on audio frequencies when used as a Voltmeter on any range, is 10 megohms so that it can be used for measuring voltages in high resistance circuits with great accuracy, current consumption from the circuit being negligible.

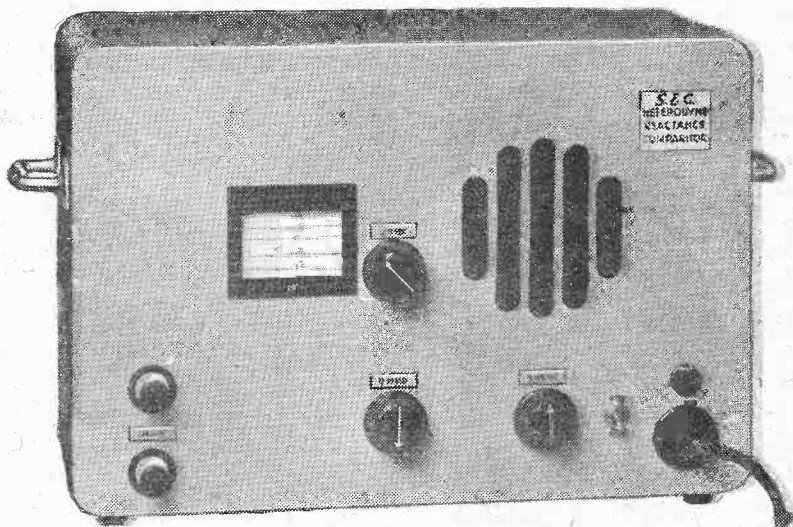

PRICE: £42-18-0

Two radio frequency oscillators, one variable, are employed and are made to beat against each other, and the resultant signal is rectified and heard on a loud speaker contained within the instrument. The variable oscillator is controlled by a knob and drum drive, the calibration of which indicates directly the percentage difference between the standard and the coil or condenser under test.

HETERODYNE REACTANCE COMPARATOR

FOR TESTING COILS AND CONDENSERS

A portable mains operated test set for the rapid checking of coils or condensers against standards under mass production conditions.

HIGH FREQUENCY TERMINALS

Registered Design No. 819,944

This new H.F. Terminal has been introduced to meet the need for a terminal of truly scientific low loss design, and as the result of considerable research into the problem of losses and insulation resistances at radio frequencies a terminal has been produced which it is believed is without equal for its purpose at the present day.

The special ceramic insulation employed is not only of very low loss type but the proportion of it in the electrostatic field is small, whilst its shape with respect to the terminal stem and mounting bush is such as to provide the minimum loss conditions.



Actual size

Write for full particulars to:—

SALFORD ELECTRICAL INSTRUMENTS LTD.
PEEL WORKS, SALFORD, 3.
PROPRIETORS: THE GENERAL ELECTRIC Co. Ltd., OF ENGLAND

Telephones: BBackfrids 8883 (3 lines) Telegrams and Cables: "SPARKLESS, MANCHESTER"

3 NEW

AVO PRECISION MEASURING INSTRUMENTS

Regd. Trade Mark

BRITISH MADE

THE already comprehensive range of world-famous 'AVO' instruments is now still further enhanced by the introduction of three new meters. The additional testing facilities thus provided will win the instant approval of all those critical engineers who have from long experience proved the outstanding merits and supremacy of every instrument that bears the name 'AVO.'



The 40-RANGE Universal AVOMETER

This multi-range combination A.C./D.C. meter supercedes the 36-range Universal Avometer, which is no longer being manufactured. Four extremely useful ranges have been added:—0-240 volts, D.C.; 0-480 volts, D.C.; 0-6 mA., A.C. and 0-12 mA., A.C., whilst resistance measurements now embody three ohms ranges employing internal batteries and a fourth using either A.C. or D.C. supply. An automatic protective cut-out is provided instead of a replaceable fuse.

(Leather carrying case, if required, 25/-) **14 Gns.**

CURRENT	
A.C.	6 mA. to 12 A. (in 8 ranges).
D.C.	6 mA. to 12 A. (in 8 ranges).
VOLTAGE	
A.C.	6 V. to 1,200 V. (in 8 ranges).
D.C.	60 mV. to 1,200 V. (in 12 ranges).
RESISTANCE	
0-1 megohm (in 4 ranges).	
Reading down to 0.1 ohm.	



ALL 'AVO' INSTRUMENTS ARE AVAILABLE ON DEFERRED TERMS IF DESIRED.

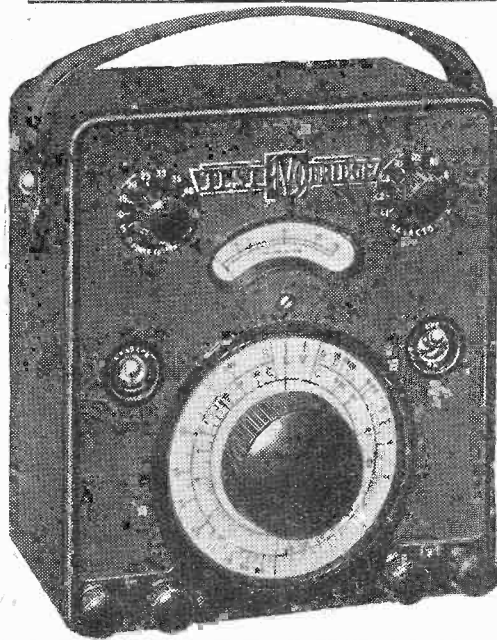

The AVO TEST BRIDGE

A self-contained 50 cycles measuring bridge of exceptional accuracy and utility. Provides for the direct measurements of all normal values of condensers and resistances. Accuracy, except at extremes of range, is **better than 5%**. Facilities also provided for condenser power-factor measurements and leakage tests, and for inductance measurements of 0.1 Henry upwards. It can be used as a wide range valve voltmeter to indicate and measure both audio and radio frequency voltages.

8 Gns.
(Leather carrying case, if required, 25/-.)

CAPACITY	
Range C.1—	From .000005 μ F to .005 μ F.
Range C.2—	From .0005 μ F to .5 μ F.
Range C.3—	From .05 μ F to 50. μ F.
RESISTANCE	
Range R.1—	From 5 ohms to 5,000 ohms.
Range R.2—	From 500 ohms to 500,000 ohms.
Range R.3—	From 50,000 ohms to 50 megohms.

Write for fully descriptive literature of these Instruments.



The AVO LOW RESISTANCE OHMMETER

A pocket size meter expressly designed to provide an exceptionally open scale for accurate readings of low resistance values. Entirely self-contained, this instrument has

TWO RANGES: 0-20 and 0-200 ohms which are selected by the appropriate button. The scale shape is such that on the lower range 1/10th of an ohm corresponds to a deflection of about 1/8th in., and 1 ohm to nearly one inch.

(Leather case, if required, 12/-) **42/-**

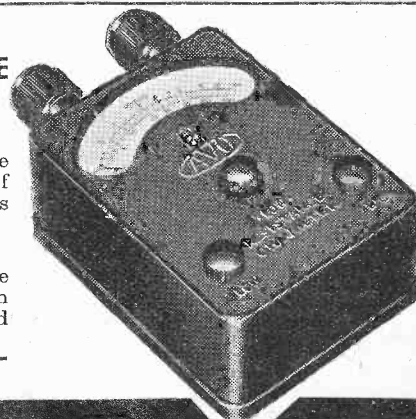

Sole Proprietors and Manufacturers:
The AUTOMATIC COIL WINDER & ELECTRICAL EQUIPMENT CO. LTD.
Winder House, Douglas St., London, S.W.1
Telephone: VICTORIA 3404/7



Come and refresh your ears!

by listening to music through a
VOIGT SPEAKER

Our programme includes:—7 metre sound (when suitable), visitors' records (preferably mornings), Promenade Concerts, Direct microphone, Medium and Long Waves, also an experimental quality tuner for Droitwich only.

Many call every year to hear these Demonstrations of our speakers with Lowther sets.

All are welcome.

COME AND BRING YOUR FRIENDS!

We are at home to all those interested in good reproduction during
RADIOLYMPIA
Aug. 23rd to Sept. 2nd
at
2, BEACONSFIELD TERRACE ROAD,
11 a.m. to 1 and 3 to 10.30 p.m.
(i.e. ½ hour after Olympia closes).

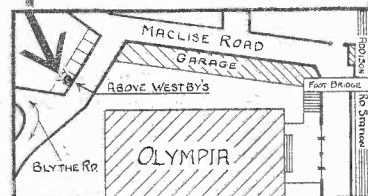

We are just opposite the main Goods Entrance at the back of Olympia.



Tel.: SYdenham 6666.

VOIGT PATENTS LTD., THE COURTS, SILVERDALE, SYDENHAM, S.E.26.

(Regd. Office: 22, Castle Street, E.C.1)

GALPINS ELECTRICAL STORES

TERMS: Cash with Order or C.O.D. Charges extra

75, LEE HIGH ROAD, LEWISHAM, LONDON, S.E.13

Telephone: **LEE GREEN 5240**

ALL GOODS SENT ON THREE DAYS APPROVAL AGAINST CASH

GROMPTON DYNAMO, 4-pole shunt wound, 1,750 r.p.m., 100 volts 10 amps., 70/- Ditto 50/75 volts 15 amps., 75/- Carriage forward.
MACKIE MOTOR GENERATOR, 220 volts 3.35 amps. D.C. input, 10 volts 30 amps. D.C. output, 37/6. C/F.
GROMPTON DYNAMOS, 4-pole shunt wound, 1,750 r.p.m., 220 volts 10 amps., 70/- Ditto, 50/75 volts 25 amps., 90/- C/F.
NEWTON MOTOR GENERATOR, 220 volts D.C. to 15 volts 10 amps. D.C., 30/- C/F.
MACKIE MOTOR GENERATOR, 220 volts D.C. to 400 volts 170 m/A. and 15 volts 8 amps. D.C. Three pieces coupled together on bedplate, 55/- C/F.
GROMPTON MOTOR GENERATOR, 220 volts D.C. to 500/750 volts 200 m/A. D.C., 40/- C/F.
DYNAMO BY ELECTROMOTORS, 400 revs., 100 volts 10 amps., shunt wound, 90/- C/F.
SMALL MOTORS. Beckenham Motor Generators, 220 volts D.C. to 500 volts 300 m/A. and 12 volts 12 amps. All three coupled together on slide rails. 35/- each. C/F.
E.C.C. SHUNT WOUND DYNAMO, 100 volts 50 amps., 1,500 r.p.m., 86/10/- C/F.
MACKIE ALTERNATOR, 120 volts D.C. input, 65 volts 1 ph. 150 cycles ½ kW. output. Vertical type, 45/- C/forward.
MACKIE DYNAMO, shunt wound, 75/90 volts 8/10 amps., 1,500 r.p.m., 55/- C/F.
C.A.V. SHUNT WOUND DYNAMOS, 25 volts 8 amps., 1,750 r.p.m., 32/6. C/F.
G.E.C. ½ H.P. A.C. INDUCTION MOTOR, 200/240 volts 50 cy. 1 ph., 1,440 r.p.m., 40/- each. C/F. Wagner ½ h.p. repulsion induction, 100/240 volts, 50 cy. 1 ph., 1,440 r.p.m., 42/6. In good condition.
G.E.C. SHUNT WOUND DYNAMOS, 50 volts 6 amps., 1,500 r.p.m., 30/- C/F.
GROMPTON SHUNT WOUND DYNAMO, 100 volts 4 amps., 1,750 r.p.m., 35/- C/F.
MARCONI ½ KW. 500 CYCLE ALTERNATOR, 100 volts, 1 phase, 45/- C/F.
HIGH-VOLTAGE TRANSFORMERS for Television, Neon, etc. 200/240 v. 50 cy. 1 ph. primary, 5,000 and 7,000 volts secondary, enclosed in petroleum jelly. Size: 5½ in. x 4½ in. x 4½ in., 7/6 each, post 1/-. Ditto, Skeleton type, 5/6, post 9d. All brand new.
EVERSHED EX-R.A.F. HAND-DRIVEN GENERATOR, in new condition, 800 volts 30 m/A. and 6 volts 2½ amps. D.C. Useful as megger genies and all test work. 20/- each, post 1/6.

MACKIE DOUBLE WOUND EX-R.A.F. GENERATORS, 1,200 volts 100 m/A. and 10 volts 4 amps., 3,000 r.p.m., 12/6 each. Carriage 1/6.
ELLIOTT MOVING COIL METER MOVEMENT, first grade, approx. 2 m/A., full scale of 6 inches, 10/6 each, post 1/-.
500/750-WATT TRANSFORMER CORES FOR REWINDS. Size: 6½ in. x 5½ in. x 1½ in. Ex Philips. 7/6 each, post 1/-.
EVERETT EDGUMBE ELECTROSTATIC VOLTMETER, 0 to 6,000 volts, 6-inch scale, 45/-, post 1/6. Ditto, 2,500 volts, 2½-inch scale, 25/-.
EX-R.A.F. ONE-VALVE VISUAL WAVEMETERS, 350 to 2,500 metres. Less valve, 4/6 each.
JOHNSON & PHILIPS HOT-WIRE RADIO FREQUENCY METERS, 4in. dial, 0 to 1.2 and 0 to 2 amps., 12/6 each, post 1/-.
SPARK COILS, 12-inch, with Condenser, 100/200 volts D.C. primary, in new condition, 83. Ditto, 2-inch, work from 12 volts with trembler, 22/6, post 1/6.
EX-G.P.O. HAND COMBINED TELEPHONE, with finger switch, 3/6 each, or 6/- a pair, post 6d.
EVERETT EDGUMBE PORTABLE THREE READING VOLTMETER, 0 to 5-25-250 volts, moving coil, first-grade movement, 4in. dial, 20/- each.
EX-TELEGRAPH MORSE RECORDER with sounder inker type, in good condition, 45/- C/F.
MUIRHEAD 1 MF. CONDENSERS, 1,000-volt working, 1/- each, post 6d.; or three for 2/6, post 1/-. Philips' 1 mf., 3,000-volt working, 5/-. T.C.C. 4 mf., 3,000-volt working, 9/6 each. Standard Telephone 1 mf., 400-volt working, 4d. each, or in lots of 100 for 12/6, post 1/6.
FERRANTI SPEAKER OUTPUT TRANSFORMERS, Type "A," ratio 7½ to 1, pri. D.C. resist. 900 ohms, impd. 12,500 to 30,000. Type "B," ratio 24.9 to 1, pri. D.C. resist. 14,000 to 20,000 ohms, impd. over 111,000. Sec. D.C. resist, 13 ohms on both types. In new condition, 2/6 each, post free.
P1 STANDARD TELEPHONE PUSH-BACK CONNECTING WIRE (new), 220-yard coils, 12/6, post 1/-.
SAVAGE MAINS TRANSFORMERS, 200/250 volts input, 50 volts 8 amps. output, 12/6 each.
STANDARD TELEPHONE MAINS TRANSFORMERS, input 200/250 volts, output 250/0/250 volts 200 m/A., 3x4 volt windings and a 50-volt winding, 12/6 each.
EVERETT-EDGUMBE THERMO-COUPLED R.F. METERS, 22in. dial, 0 to 250 m/A., 25/-; 0 to 3 amps., 20/- each. A few only Everett-Edgumbe Thermo Meters with Thermo burnt out, but moving coil reads approx. 1 m/A. A first-grade movement, 10/- each.

SILVERTOWN GALVANOMETERS, jewelled movement, very sensitive, 5/- each.
SULLIVAN TRANSMITTING CONDENSERS, variable in glass tank, .0005 mf. and .001 mf., 7/6 each, post 1/-.
INSTRUMENT WIRE, 4-lb. reels of 20 G enamel, 6/-, P/F; 15 lb. of 16 gauge enamel, 15/-, post 1/-; 7 lb. of 18 gauge D.C.C., 8/6, post 6d.; 7 lb. of 10 gauge D.C.C., 10/-, P/F. All new wire.
ERNEST TURNER & WESTON 2-in. DIAL MOVING COIL MILLIAMPMETERS, B.S. first grade, 0 to 5 and 0 to 150, 10/6 each.
"PHILIPS" MAINS TRANSFORMERS, 200/240 volts input, 2,000/0/2,000 volts 200 m/A. output, with two L.T.s, 22/6 each. C/F.
WESTINGHOUSE RECTIFIERS, L.T. 6 volts 2 amps. D.C. output, input 11 volts, in new condition, 10/- each.
MOVING COIL METER MOVEMENTS for recalibrating into multirange meters. Low m/A. deflection. 2½-in. dial, 5/- each; 4-in. and 6-in. dial, 6/- each. Post 1/-. (Note: All these meters are by good makers—Elliott, E. Edgumbe, etc.)
ELECTRIC LIGHT CHECK METERS, 200/250 volts, 50 cy. 1 phase, 5 and 10 amps., 6/- each. P/F.
X-RAY TRANSFORMERS, by well-known makers, all fully guaranteed. 50 cycle mains, 40,000 volts, 10 m/A., 85; 68,000 volts, 20 m/A., 87/10/-; 100,000 volts, 30 m/A., 810/10/-. All carriage forward.
ZENITH VITREOUS WIRE WOUND RESISTANCES, 2,500 ohms 170 m/A., 750 ohms 300 m/A., 4,500 ohms 100 m/A., 800 ohms 170 m/A., 5,000 ohms 71 m/A., 250 ohms 500 m/A. All at 1/- each, post 4d.
THE "RACON" MOVING COIL HORN SPEAKER UNITS, 15-ohm Speech Coil, 6-volt, fitted handle, 15 watts, 15/- each, post 1/6.
EX-NAVAL 1-VALVE BUZZER WAVEMETERS, 200/24,000 metres. Complete in solid teak case. Size: 15x10x8 (less valve). Turner unit enclosed in copper tank (Sullivan high note buzzer). Price, 7/6 each. C/B. Not sent C.Q.D.
EX-G.P.O. GLASS TOP RELAYS, Type B. Useful as Keying Relays, 5/- each, post 6d. Also a few only that need points, which are easily fitted, 2/6 each. P/F.
T.C.C. 2,000 MF. ELECTROLYTIC CONDENSERS, 50-volt working (brand new), 5/- each, post 6d.
STANDARD TELEPHONE BELL WIRE, all brand new. 150-yd. coils, twin 22 gauge, 4/-, post 9d.; 250-yd. coils, single 16 gauge, 4/-, post 1/-; 300-yd. coil, single 22 gauge, 3/-, post 6d.

Mention of "The Wireless World," when writing to advertisers, will ensure prompt attention.

The Wireless World

THE
PRACTICAL RADIO
JOURNAL
29th Year of Publication

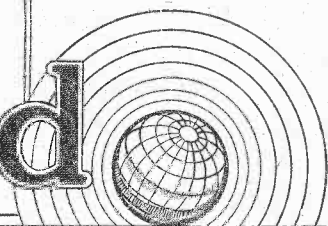
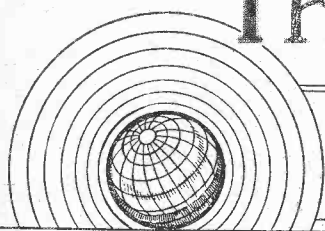

No. 1042.

THURSDAY, AUGUST 17TH, 1939

VOL. XLV. No. 7.

Proprietors : ILIFFE & SONS LTD.

Editor :
HUGH S. POCOCK.

Editorial,
Advertising and Publishing Offices :
DORSET HOUSE, STAMFORD STREET,
LONDON, S.E.1.

Telephone: Waterloo 3333 (50 lines).
Telegrams: "Ethaworld, Sedist, London."

COVENTRY: 8-10, Corporation Street.
Telegrams: "Autocar, Coventry." Telephone: 5210 Coventry.

BIRMINGHAM:
Guildhall Buildings, Navigation Street, 2.
Telegrams: "Autopress, Birmingham." Telephone: 2971 Midland (5 lines).

MANCHESTER: 260, Deansgate, 3.
Telegrams: "Iliffe, Manchester." Telephone: Blackfriars 4412 (4 lines).

GLASGOW: 26B, Renfield Street, C.2.
Telegrams: "Iliffe, Glasgow." Telephone: Central 4857.

PUBLISHED WEEKLY. ENTERED AS SECOND CLASS MATTER AT NEW YORK, N.Y.

Subscription Rates :
Home and Canada, £1 10s. 4d. ; other countries, £1 12s. 6d. per annum.

As many of the circuits and apparatus described in these pages are covered by patents, readers are advised, before making use of them, to satisfy themselves that they would not be infringing patents.

CONTENTS

	Page
Editorial Comment	139
"The Wireless World" Pre-Set Quality Receiver : Six Stations with Switch Tuning	140
Problem Corner	144
Plans for Olympia	144
Television Programmes	144
Colour Television	145
The Berlin Show	147
Five-metre DX	150
News of the Week	151
Modern Detector Circuits (concluded)	153
Twist or Press? : For and Against Push-button Tuning	156
R.G.D. Model 166 : Test Report	156
Random Radiations	158
Letters to the Editor	160
Recent Inventions	162

EDITORIAL COMMENT

Post Office Relays

Switching Over to the Mains

JUST as wireless users and the wireless industry are recovering from the shock which the Postmaster-General gave them when he announced some time back that the Post Office would develop a wireless relay system on a national scale utilising the telephone system, now another shock is pending.

This time it is as a result of a reply in the House of Commons made by the Postmaster-General in which he indicated that the Post Office was actively investigating the possibility of utilising electric supply mains to domestic premises as a means of distributing broadcasting.

Enquiries which we have since made indicate that some rapid moves have taken place recently which have been kept surprisingly secret considering the number of persons concerned. We learn that the wireless industry has not been consulted, but that the electric supply companies have expressed a willingness to co-operate with the Post Office in the utilisation of their cables and wires for this purpose and that the Electricity Commissioners are giving their blessing to the enterprise. The Municipal electricity authorities have been approached and are unlikely to offer opposition.

Legal Objections

It has hitherto been considered that when technical difficulties in the way of injecting broadcasting through electric supply cables were satisfactorily overcome there would still be an insuperable difficulty in the fact that there is a statutory ban on electric supply companies utilising their wires

for the purpose of transmitting any communication, but it is understood that the position could be legalised at very short notice; no doubt as a national defence measure. It is not clear yet from such information as we have been able to gather whether broadcast relaying by utilisation of the electric supply wires would be in substitution of the present Post Office scheme for carrying out the same work by means of telephone lines or in addition.

Assurances have recently been given that practically all the technical difficulties have been overcome and statements to this effect have been made, particularly by Captain P. P. Eckersley, formerly chief engineer of the B.B.C. and now actively interested in broadcast relay developments.

P.O. Assurances

The attitude which the radio industry and users of broadcast wireless sets will now adopt towards this proposal is governed, we consider, by the assurances which the Post Office has already given in connection with the proposal to develop a telephone relay system. These assurances must automatically apply with equal strength if a switch-over to electric supply mains is made or if this is done in addition to the telephone medium. The assurances given by the Post Office were that they would never compete with industry in the supply and maintenance of receivers for the reception of these relays and that their efforts to reduce electrical interference with broadcast reception would not slacken. Such assurances, we said at the time, were vitally necessary if the good will of the radio industry, both manufacturers and dealers, was to be retained and the Post Office assisted rather than hampered in their national effort.

The Wireless World

WHEN high quality local reception is required switch-tuning offers many advantages, chief among which is the possibility of obtaining independent control of the band-width of the RF circuits for each station without adding to the complexity of the equipment. In the receiver described in this article six stations are catered for, and it includes such refinements as independent bass and treble tone controls.

MANY people are interested primarily in high-quality reproduction and are content with reception from a moderate number of stations. Indeed, they have to be, for the highest standard of reproduction is still unobtainable in the case of distant transmissions on account of the necessity for avoiding interference. High quality demands three things—the avoidance of amplitude distortion, the equal amplification of all audio frequencies, and the removal of all extraneous sounds—and the two last are often mutually incompatible.

The complete removal of interference is nearly always impossible; all that can be done is to reduce it below the limit of audi-

bility of the human ear. If this can be done while leaving the wanted signal unaffected, the interference can be said to be eliminated. The amount of interference attenuation that has to be introduced in any case, however, depends on the initial ratio of the signal to the interference.

It is clear, for instance, that if at a certain setting of receiver gain interference is inaudible and the wanted signal is strong enough at this gain to give the required volume, no steps need be taken to reduce interference. It is at this receiving point swamped by the wanted signal. Now if the signal strength gradually declines we have to increase the receiver gain to keep the output constant, and we at length find

that the interference begins to be noticeable. At length the signal is weaker than the interference and becomes swamped by it.

Interference is here taken to include all forms, and some can be reduced without affecting the frequency response of the receiver. Many types of interference, however, can only be reduced by methods which restrict the frequency response and so spoil the quality of reproduction.

With the present spacing of transmitters it is only possible to receive at the highest quality those stations which, at the point of reception, give a considerably stronger signal than their immediate neighbours in the frequency spectrum. In general, it is found that only local stations provide an adequate signal strength to override interference, and consequently many quality enthusiasts confine their listening to such stations.

If a somewhat lower, but still a good, standard of quality is accepted, the range of reception can be considerably extended. The receiver can then be provided with a

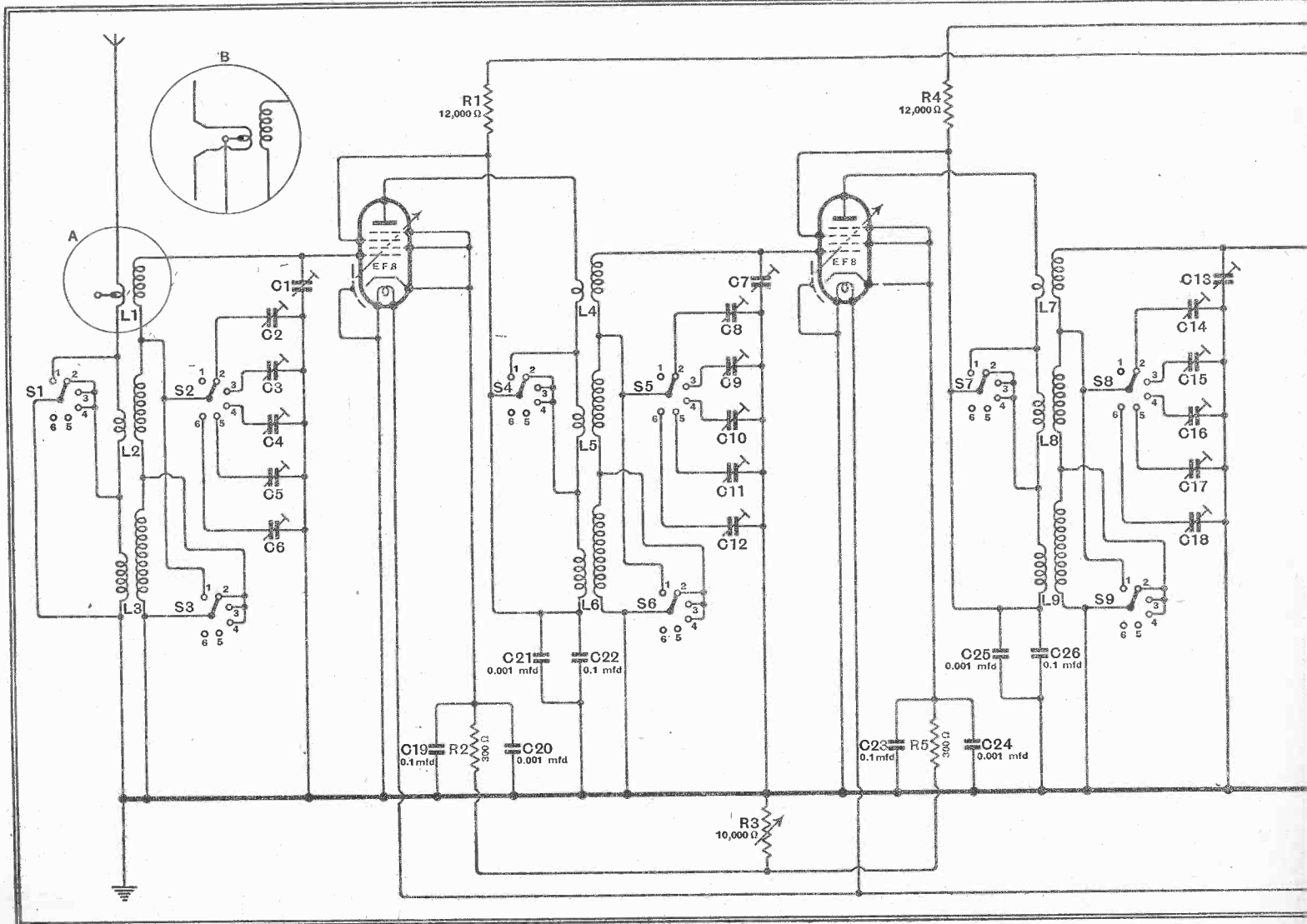

Pre-set Quality Receiver

SIX STATIONS WITH SWITCH TUNING

fair amount of selectivity and many of the more powerful Continental stations can be received without interference.

With a still greater restriction of the frequency response, still weaker signals can be obtained free from interference, and if the aim is to obtain very long distance reception it is well known that a considerable sacrifice of quality must be made.

It will now be clear that there is an optimum frequency response, dictated by the selectivity-quality compromise, for the reception of any station, and that it will vary with the location of the receiver and even from hour to hour. Fortunately, the

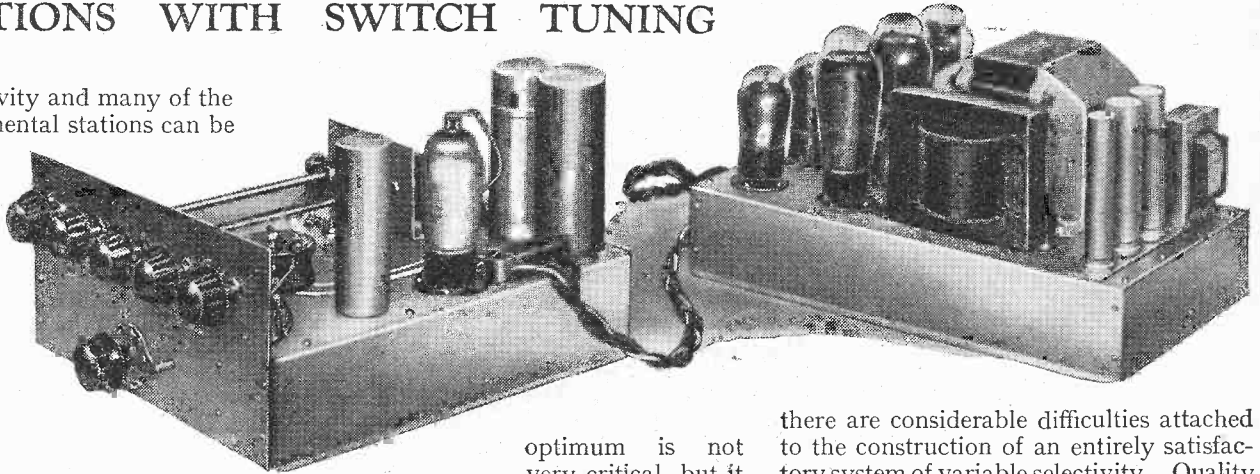

optimum is not very critical, but it demands the use of variable selectivity in a general-purpose quality receiver; that is, in a receiver which is to cater for a wide range of signals and to give the best attainable quality on each.

Such receivers are apt to become complicated and expensive largely because

there are considerable difficulties attached to the construction of an entirely satisfactory system of variable selectivity. Quality enthusiasts consequently often confine themselves to local reception, but there are many who need a little more than this. They want chiefly the local stations, but occasionally want one or two more distant ones.

Even for local reception fixed selectivity is not ideal, because different users are at

different distances from the station and their local conditions are not the same. Any one user can have fixed selectivity, since his conditions are not likely to vary much, but his optimum may not be the same as that of other people. Moreover, the selectivity he needs may not be the same for all the "local" stations. Some form of adjustable selectivity is obviously needed.

Now it is clear that these requirements could be met by using a conventional tuning system in conjunction with a good variable selectivity system. This demands a certain amount of skill in operation, however, for not only must the receiver be properly tuned but the selectivity control must be operated correctly. It is often considered more convenient to have some form of pre-set tuning with switch or push-button control and this has considerable technical advantage from our point of view.

Fig. 1.—Alternative aerial connections are shown according to whether an inverted L aerial is used or a dipole. With the former the connections A should be adopted, but with the dipole the system shown at B must be used.

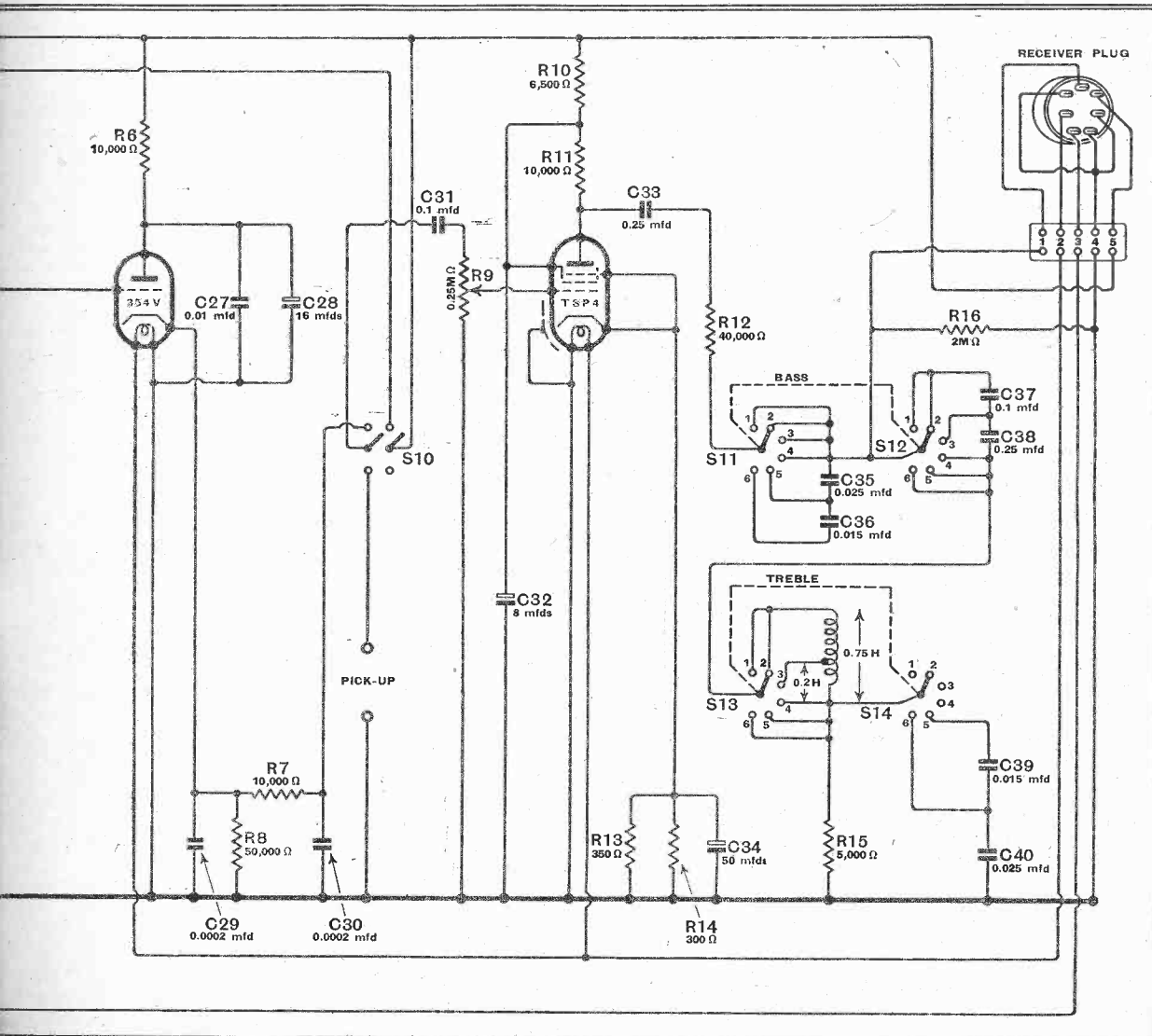

The Wireless World Pre-Set Quality Receiver—

Suppose we use a straight set with several tuned circuits. When all are tuned to resonance we shall get maximum selectivity and sensitivity. If we now mistune

the ones desired. With separate condensers for each station it is easy to adjust the band-width to the right value for each station, and on switching from one station to another the band-width is automatically changed and without any circuit complication.

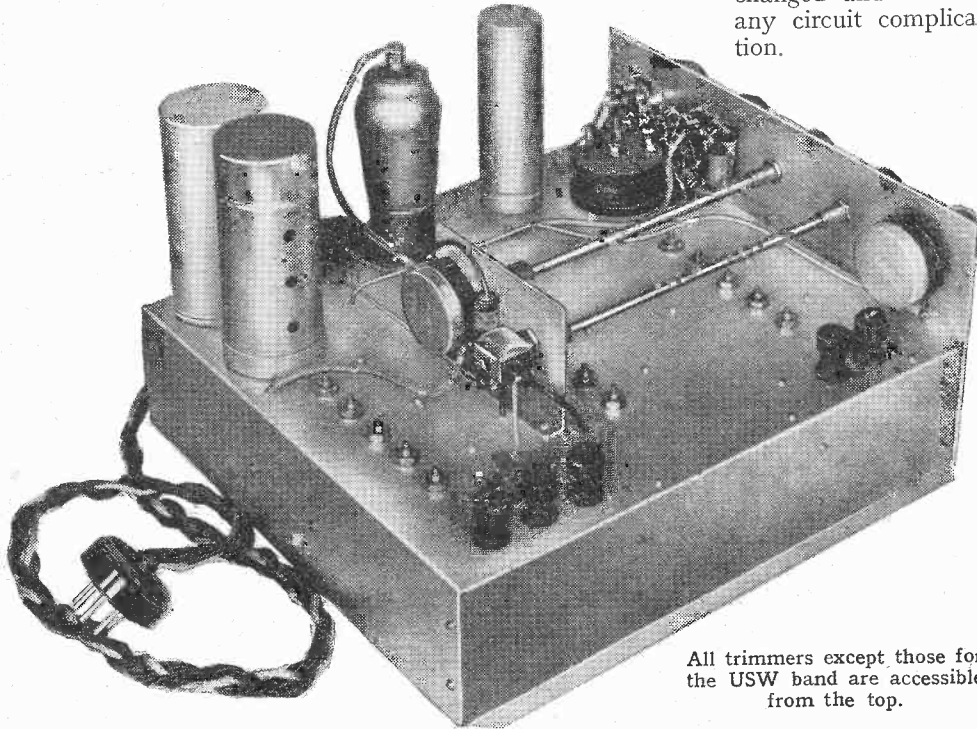

All trimmers except those for the USW band are accessible from the top.

some of the circuits slightly in opposite directions we shall broaden the resonance curve and get a band-pass effect; we shall also lower the sensitivity.

With pre-set tuning we can provide a separate set of tuning condensers for each station required and use switching to select

This does enable quite a big improvement in reproduction to be secured in many cases. It is especially noticeable on Droitwich, for most receivers are far too selective on the long waveband for high-quality reproduction. With proper adjustment of the circuits the quality from Droit-

wich is hardly distinguishable from that of a medium-wave local station.

The stations required will naturally depend on the taste of the user and his geographical location, so that a considerable latitude for choice must be allowed. It is expected that in most parts of the country Droitwich will be wanted as well as at least one medium-wave Regional programme. In many cases a medium-wave National station will be wanted, and in London, and possibly in some provincial areas in the future, Television Sound. At least one extra channel on medium and long waves should be allowed for more distant stations.

In the Pre-set Quality Receiver a maximum of six stations is provided, because multi-way switches suitable for ganging with more than six contacts are difficult to obtain. Six stations are available, therefore, and are grouped as one on ultra-short waves, three on medium waves and two on long waves. This gives Television Sound, MW Regional and National, and LW Droitwich, and leaves one channel on medium and one on long waves for other more distant stations.

The arrangement adopted is shown in Fig. 1. In order to secure adequate sensitivity for local reception with the poorest aerials and for more distant stations with a reasonably efficient aerial, two RF stages are used. There are three tuned circuits, the last of which acts as a coupling between the second RF stage and the detector. A diode is not used here because its comparatively low input resistance would damp the tuned circuit heavily and so give poor selectivity. Instead, the negative feed-back or so-called infinite input

LIST OF PARTS

- Receiver.*
- Condensers:
- 2 0.015 mfd., tubular, C36, C39
 - 2 0.025 mfd., tubular, C35, C40
 - 6 0.1 mfd., tubular, C19, C22, C23, C26, C31, C37
 - 2 0.25 mfd., tubular, C33, C38
 - 2 0.0002 mfd., mica, C29, C30
 - 4 0.001 mfd., mica, C20, C21, C24, C25
 - 1 0.01 mfd., mica, C27
 - 1 8 mfd., electrolytic, 500 volts, C32
Dubilier 0281
 - 1 8-8 mfd., electrolytic, 500 volts, C28
Dubilier 9203E
 - 1 50 mfd., electrolytic, 12 volts, C34
Dubilier 3016
- 3 Trimmers, 1-30 mmfds., C1, C7, C13
Eddystone 1100
- 3 Trimmers, 175 mmfds., C2, C8, C14
Bulgin CP2
- 6 Trimmers, 300 mmfds., C3, C9, C15, C5, C11, C17
Bulgin CP3
- 6 Trimmers, 600 mmfds., C4, C10, C16, C6, C12, C18
Bulgin CP4
- Resistances:
- 3 300 ohm, 1/2 watt, R2, R5, R14 Erie
 - 1 350 ohm, 1/2 watt, R13 Erie
 - 1 5,000 ohm, 1/2 watt, R15 Erie
 - 2 10,000 ohm, 1/2 watt, R6, R7 Erie
 - 1 40,000 ohm, 1/2 watt, R12 Erie
 - 1 50,000 ohm, 1/2 watt, R8 Erie
 - 1 2 megohm, 1/2 watt, R16 Erie
 - 2 12,000 ohm, 1 watt, R1, R4 Erie
 - 1 6,500 ohm, 2 watt, R10 Erie
 - 1 10,000 ohm, 2 watt, R11 Erie
 - 1 Potentiometer, 0.25 megohm, tapered, Reliance SG
 - 1 Potentiometer, 10,000 ohms, wire-wound, R3 Reliance TW
 - 1 Choke, 0.75 H., tapped at 0.2 H. Peto-Scott

- 1 Switch Assembly, 6-way, comprising locator, and 12-inch rod, 3 single-pole plates and 3 double-pole plates (without earthing plates), S1, S2, S3, S4, S5, S6, S7, S8, S9 Peto-Scott
- 2 RF Transformers, medium-wave, L5, L8 Wearite PHF2
- 1 Aerial Transformer, medium-wave, L2 Wearite PA2
- 2 RF Transformers, long-wave, L6, L9 Wearite PHF1
- 1 Aerial Transformer, long-wave, L3 Wearite PA1
- 2 RF Transformers, USW (see text), L4, L7
- 1 Aerial Transformer, USW (see text), L1
- 1 Length, 8 in., 1/4 in. rod Peto-Scott
- 1 Length, 8 1/2 in., 1/4 in. rod Peto-Scott
- 2 Lengths screened sleeving Goltone
- 2 Double-pole, 6-way, switches, S11, S12, S13, S14 Bulgin S.202
- 1 Switch, DPDT, rotary, S10 Bulgin S.114
- 2 Shaft couplers, 1/2 in. Bulgin 2005
- 2 Panel bushes, 1/4 in. Bulgin 1048
- 5 Terminals A(2), E, PU(2) Belling-Lee
- 1 Valve screen Peto-Scott
- 1 Valveholder, 5-pin Clix XIII
- 1 Valveholder, 7-pin Clix XII2
- 2 Valveholders, 8-contact Bulgin VH24
- 3 Valve top-clips Belling-Lee 1175
- 1 Connector, 5-way Bryce
- 1 Cable, 6-way, with twin 70/36 leads Goltone
- Chassis, Aluminium Peto-Scott
- Valves:
 - 2 EF8 (met.) 1 354V (plain), 1 TSP4 (met.) Mullard

Amplifier.

- 1 Mains transformer: Sound Sales
Primary, 200/250 V, 50 c/s; Secondaries, 350-0-350 V, 150 mA; 4 V, 2 A CT; 4 V, 2 A; 4 V, 3 A; 4 V, 3 A; 6.3 V, 0.4 A.

- 1 Smoothing choke, 10H, 150 mA, 100 ohms Premier Supply Stores
- 1 Smoothing choke, 20H, 50 mA, 400 ohms Bulgin LF14S

- Condensers:
- 2 0.01 mfd., tubular, C1, C2
 - 2 0.1 mfd., tubular, C3, C4
 - 1 4 mfd., electrolytic, 500 V, C8 Dubilier 0283
 - 1 8 mfd., electrolytic, 150 V, C5 Dubilier 3017
 - 2 8 mfd., electrolytic, 500 V, C6, C7 Dubilier 0281
 - 1 50 mfd., electrolytic, 50 V, C9 Dubilier 3004

- Resistances:
- 2 50 ohm, 1/2 watt, R13, R14 Erie
 - 1 600 ohm, 1/2 watt, R4 Erie
 - 2 10,000 ohm, 1/2 watt, R11, R12 Erie
 - 2 40,000 ohm, 1/2 watt, R6, R8 Erie
 - 1 150,000 ohm, 1/2 watt, R5 Erie
 - 2 2 megohm, 1/2 watt, R1, R2 Erie
 - 2 0.25 megohm, 1/2 watt, R9, R10 Erie
 - 1 15,000 ohm, 1 watt, R3 Erie
 - 1 400 ohm, 20 watt, R15 Bulgin PR
 - 1 20,000 ohm, wire-wound potentiometer, Reliance TW
 - 3 Valveholders, 4-pin Clix XIII
 - 2 Valveholders, 5-pin Clix XIII
 - 1 Valveholder, 7-pin Clix XII2
 - 1 Cable plug, 7-pin Bulgin P.37
 - 1 Plug and socket, 3-way Belling-Lee 1119
 - 1 Plug and socket, 2-pin, mains input connector Belling-Lee 1115
 - Chassis Peto-Scott
 - Valves:
 - 1 FW4/500, 2 AC044, 2 354V (plain) Mullard

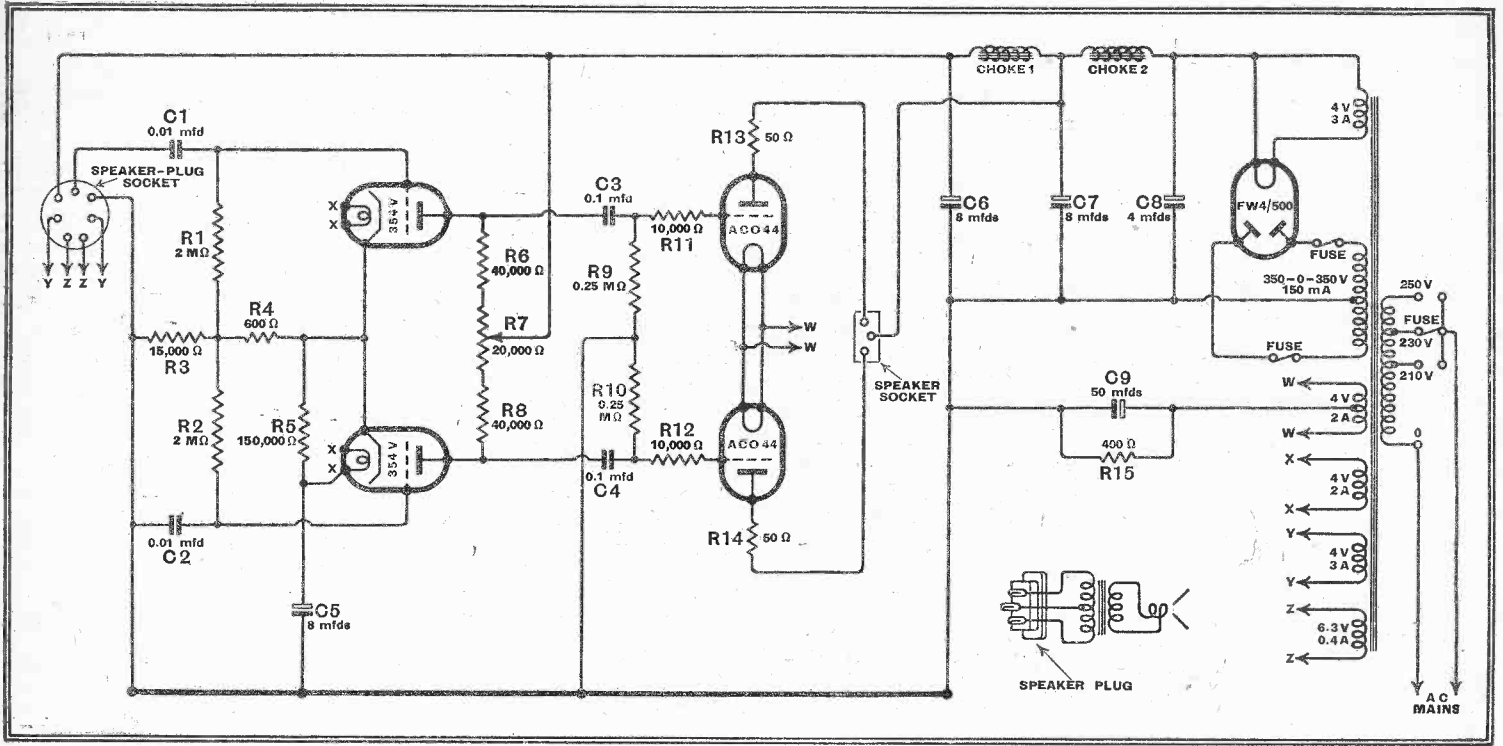

Fig. 2.—The AF amplifier is resistance-coupled push-pull, the necessary phase-reversal being obtained with the aid of the cathode resistance R3. The potentiometer R7 is provided for balancing.

impedance anode-bend detector is used. This detector is rather better than the diode from the point of view of quality and it has the great advantage that its input resistance can be made anything one likes within quite wide limits. If required it can be made infinite, but in general it is adjusted to be very high and negative so that a small amount of regeneration is introduced. This greatly sharpens the tuning of its input circuit and also increases the amplification.

As compared with the diode the detector has two drawbacks, which are not important in this case. As it needs an HT supply, the anode circuit must be thoroughly decoupled, and it cannot provide AVC. In a receiver of this nature AVC is hardly necessary. A system separate from the detector could, of course, be included, but it would have to be quite a complex arrangement if it were not to introduce the disadvantages of the diode. It does not, therefore, seem worth while to include it.

It will be seen in Fig. 1 that in each coupling a three-pole six-way switch is used; one section changes over the primary coil connections, another the secondary coil connections, and the third selects the required tuning capacity.

The switching is arranged so that it introduces a minimum of loss in the ultra-short-wave circuits. The ultra-short-wave coils are always in circuit and the other inductances are introduced in series with them. Air-dielectric trimmers are used on this band and are always in circuit; their settings consequently affect those of the other trimmers. This is done to reduce switching losses where they are most important and means that these trimmers must be adjusted before any of the others. All other trimmers are completely independent of one another.

Following the detector is a low gain tone control stage with a television-type

RF pentode. The method of control adopted was fully described in a recent article,¹ and it is consequently unnecessary to treat it in detail here. One switch enables the bass response to be increased above or reduced below normal, while another permits a similar and independent control of the treble. Each enables five different response curves to be obtained, or a total for the two of

wanted sixth position is wired up, but the response on it is the same as on the adjacent position.

The power unit contains a resistance-coupled push-pull amplifier with an output of about 7 watts. Its design is based on

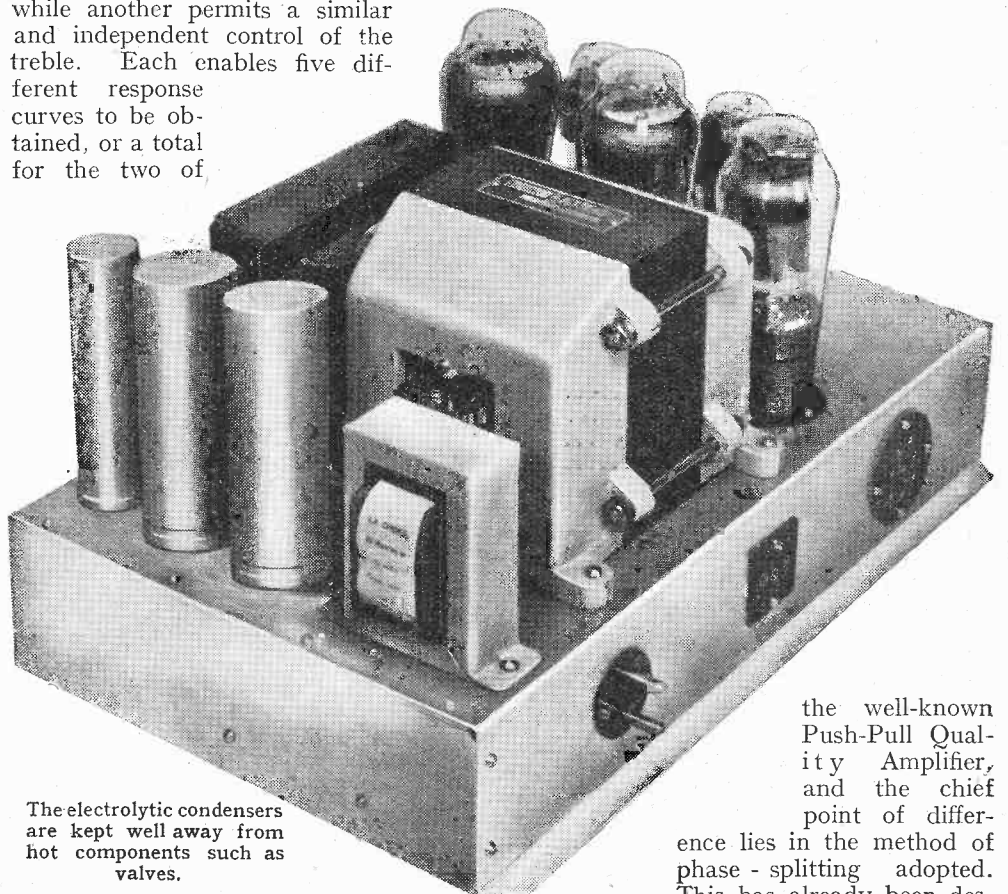

The electrolytic condensers are kept well away from hot components such as valves.

twenty-five. It should be noted that six-way switches are shown on the diagram; this is because the standard components employed have six positions. The un-

the well-known Push-Pull Quality Amplifier, and the chief point of difference

lies in the method of phase-splitting adopted.

This has already been described² in detail, but the heater connections of the penultimate stage are unusual and consequently call for some comment.

¹ The Wireless World, June 8th, 1939.

² The Wireless World, April 12th, 1939.

The Wireless World Pre-set Quality Receiver—

The cathodes of these valves are positive with respect to earth by the voltage drop across R₃ and R₄, some 80 volts. If the heaters are earthed this voltage appears between heater and cathode, and the valves used are rated for a maximum of 50 volts here. Experience has shown that to connect the heaters to the cathodes directly is not always satisfactory, since it sometimes introduces mains hum. The difficulty is overcome by joining heaters and cathodes by a resistance R₅, so that they are at the same steady potential, and earthing the heaters through a large capacity condenser C₅. So far as AC is concerned the heaters are at earth potential, but to direct current they are at cathode potential. This avoids hum troubles while making it possible to operate the valves within the makers' rating.

(To be concluded.)

Henry Farrad's

PROBLEM CORNER

No. 33—Valve Replacement

An extract from Henry Farrad's correspondence, published to give readers an opportunity of testing their own powers of deduction:—

2, Tanner Road,
Shillingsworth.

My Dear Henry,

We still have the same set I wrote to you about a few months ago—remember you prescribed a new frequency-changer valve, and advised me to consider renewing the others? Well, I decided that the IF valve—a Mazda ACVP1—had reached the retirement age. But I couldn't get a replacement locally. However, the man had a Mullard VP4B in stock, and having been bitten before by replacements with "improved" characteristics I satisfied myself that the VP4B was as near the ACVP1 as makes no matter—both give the following data in the instructions:—

Heater volts	4
Heater amps.	0.65
Anode volts (max.)	250
Screen volts (max.)	250
Mutual conductance	2.0

The only thing that seems different is the grid bias, which is -4V for the Mazda and -3V for the Mullard. But that oughtn't to make a great deal of difference, surely? At any rate not enough to prevent the VP4B from working altogether; for that is what happens! I can't get anything out of it at all; yet the man says it is perfectly all right. So what?

Yours ever,
Bob.

If the replacement valve is in order, why doesn't it work? Henry Farrad's solution is on page 159.

Index and Binding Case

The index for Volume XLIV of *The Wireless World*, January to June, 1939, is now available from the Publishers, Dorset House, Stamford Street, London, S.E.1., price 4d., post free, or with binding case price 3s. 1d., post free.

Plans for Olympia

NEW FEATURES : TECHNICAL CONVENTIONS

THE decision of the organisers of Radiolympia to cater for a wider diversity of tastes than hitherto is now being put into effect, and according to the latest reports the Show that opens its doors next Wednesday promises to have something for everyone—not excluding those whose main interest lies in the technique of radio.

The man-in-the-street has not been neglected. For him there will be a radio theatre on even more ambitious lines than previously at which he will see his favourite "stars" in the flesh, to say nothing of a beauty competition. Turning to less frivolous matters, the B.B.C. is staging a demonstration to show, by means of recordings, recent technical advances in receiver design. Reproduction simulating that by a receiver of a few years ago will be followed immediately by the same item as given by a modern set. These demonstrations are to be given hourly in the Olympia Cinema, and should attract not only the technically minded, but all who take an intelligent interest in their sets.

Government departments have already figured among the exhibitors, but this year they are to be present on a more ambitious scale. The Navy, Army, Air Force and Post Office are to show by actual demonstrations something of the part played by wireless in their various activities.

A series of technical conventions constitute an entirely new venture on the part of the organisers, and one that may well grow into an important part of the annual Show. According to present arrangements there will be four separate meetings, each day being devoted to a different subject. The series will open with a discussion on British technical progress, and some comparisons with America. It will not be surprising if the main speakers, and also those of the audience who take part in the subsequent discussion, come to the conclusion that not quite all the good things in radio come from the other side of the Atlantic.

The convention programme as at present arranged is as follows:—

August 28th, 3.30 p.m.—British Technical Progress and some Comparisons with America. Opened by Mr. M. G. Scroggie.

August 29th, 3.30 p.m.—Quality Reproduction, and what it means to-day. Opened by Mr. P. G. A. H. Voigt (with demonstrations).

August 30th, 6.0 p.m.—Short-wave Topics: Tuning Systems and Methods of Band-spreading; Short-wave Frequency Changers.

August 31st, 6.0 p.m.—Television.

Admission to Olympia will entitle those interested to free admission to the Convention Hall inside the building.

Another new exhibit is a Model Factory, where various processes in the production and testing of a receiver in course of manufacture will be demonstrated.

Television Programmes

Sound 41.5 Mc/s

Vision 45 Mc/s

An hour's special film transmission intended for demonstration purposes will be given from 11 a.m. to 12 noon each weekday except Wednesday. The National or Regional programme will be relayed on 41.5 Mc/s from approximately 7.45 to 9 p.m. daily.

THURSDAY, AUGUST 17th.

3, Gaumont-British News. 3.10, "Rule Britannia," ballads of Britain and the Seven Seas. 3.55, Cartoon Film.

9, "A Bedfast Prophet," a comedy adapted for television, from "A Rogue in a Bed," by Ronald Elwy Mitchell. 9.25, British Movietonews. 9.35, Moiseiwitsch, pianoforte. 9.45, "X = O." A poetic play by John Drinkwater. 10.15-10.35, Film. "Net Result."

FRIDAY, AUGUST 18th.

3, Western Cabaret with Big Bill Campbell. 3.45, British Movietonews. 3.55, Cartoon Film. 9, Cabaret, with Nismo King and Hubert. 9.30, Gaumont-British News. 9.40, American Painting. A description of representative American paintings by Geoffrey Grigson. 9.55, Film. 10.5, Charles Heslop in "Percy Ponsonby Catches the 9.15." 10.15-10.25, Florence Hooton, 'cello.

SATURDAY, AUGUST 19th.

2.30, Final Test Match between England and the West Indies, televised from Kennington Oval. 3.30, Vanity Fair. 3.45, Cartoon Film. 3.50-4.30, Test Match continued. 5.30-6.30, Test Match continued.

9, British Movietonews. 9.10-10.40, "The Ringer," by Edgar Wallace. Cast includes Henry Oscar and Judy Kelly.

SUNDAY, AUGUST 20th.

9.5-10.30, "The Rising Sun," a play by Herman Heijermans. Cast includes Harcourt Williams and Josephine Wilson.

MONDAY, AUGUST 21st.

2.30, Test Match O.B. 3.30, "Three in a Bar," by Peter Franklin. 3.50-4.30, Test Match continued.

5.30-6.30, Test Match continued.

9.5, British Movietonews. 9.15, Starlight, Rawicz and Landauer. 9.30-10.30, Western Film, "Galloping Dynamite."

TUESDAY, AUGUST 22nd.

2.30, Test Match O.B. 3.30, Alfredo and his Gypsy Orchestra. 3.50-4.30, Test Match continued.

5.30-6.30, Test Match continued.

9, Gaumont-British News. 9.10-10.30, "The Pelican," a play by F. Tennyson Jesse and H. M. Harwood. Cast includes Athole Stewart and Mabel Terry-Lewis.

WEDNESDAY, AUGUST 23rd.

11-12, "Come and be Televised," O.B. from Radiolympia.

3, Fashions and Bobby Howes Band, O.B. from Radiolympia. 3.30, Gaumont-British News. 3.40, Horace Goldin, illusionist, introducing "Sawing through a Woman."

9, Paul Robeson. 9.10, British Movietonews. 9.20, Mixed programme including Markova. 9.30, Naunton Wayne, comedian. 9.40, Cartoon Film. 9.45-10.15, A Bee, "Word and Line."

Colour Television

Baird Experimental System Described

By NORMAN W. MAYBANK

ON July 27th a very great advance in television technique was demonstrated by Mr. J. L. Baird at his laboratories in Sydenham. Here for the first time was shown television in natural colours, using at the receiver a cathode-ray tube. It gives the writer much pleasure to be able to place before the readers of *The Wireless World* the details of the apparatus employed.

Before doing this it is necessary to state that some section of the public will no doubt be thinking that this new advance will cause a change to be made in the normal television service and possibly put off purchasing a television set until such time as it is possible to have one which will give coloured pictures. This idea should be killed at once. The apparatus used by Mr. Baird is of a totally different type to that employed by the B.B.C. and at present can only be considered as a very successful experiment which may in

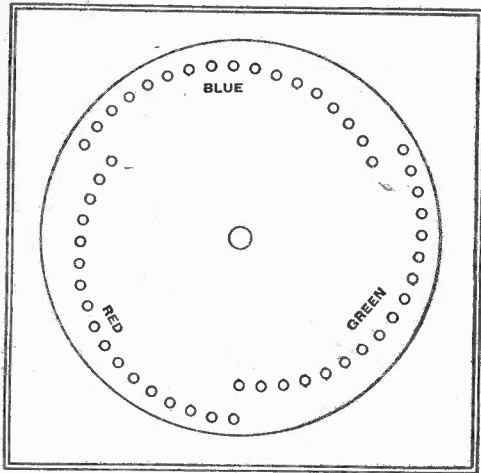

Fig. 1.—The three-colour scanning disc used in early experiments.

the near future be used for cine-television, but which will certainly not be introduced into the normal television service for many years.

Before dealing with the apparatus in question it may be of interest to readers to review some of the other demonstrations of colour television that have been given by Mr. Baird and see the manner in which the present apparatus has been evolved.

It will come as a shock to many readers to learn that colour television was first demonstrated as early as 1928, when Mr. Baird showed the transmission and reception of simple television images in colour to members of the British Association at the annual meeting held in Glasgow. The fact that this experiment made use of a line instead of wireless for the transmission channel does not detract in any way from the greatness of the achievement.

The apparatus employed consisted of a modified form of scanning-disc type spotlight scanner at the transmitting end in conjunction with similar gear at the receiving end. The difference between the then conventional spotlight scanning system and the one here described being that instead of the disc having only one set of scanning apertures arranged in spiral formation, it had three sets, one set being covered with a red, another with a blue and the third with a green filter. Fig. 1 shows this disc, and it can be seen from this that the object was scanned three times in one revolution of the disc, each time with a different colour, so that the object was scanned first by a red spot, then by a blue and then a green. In this manner three images were obtained corresponding to the red, blue and green components of the picture. At the receiving end a similar disc was arranged to revolve in synchronism with the transmitting disc. Behind the disc were arranged glow discharge lamps, modulated by the incoming signal from the transmitter. Since at the transmitter an image representing the red, blue and green components of the scanned object were transmitted in order, then, at the receiver, since these images were viewed through similar filters in the same order and speed, then the viewer saw a picture in a combination of the three primary colours from which, as is generally known, most colours and colour tones may be obtained.

The picture so obtained was, of course, exceedingly small, about two inches square, and owing to the low period of scanning suffered from a marked flicker, but, nevertheless, it constituted a noteworthy step in the right direction.

In February, 1938, ten years after the experiment described above, a demonstration of colour television was given at the Dominion Theatre. Again a mechanical system was employed, but of a greatly modified form. A new system of scanning also was used, and this is of sufficient interest for the writer to spend a little time in describing it. Interesting not only because it was employed in the apparatus to be described, but also because in the opinion of several people this form of scanning has great possibilities for the future.

Multi-mesh Scanning

The multi-mesh system of scanning is not entirely new; in fact, it was being used by Mr. Baird in his very early experiments as far back as 1923, but was not carried on with, since the scanning gear became too complicated to merit its use in a television apparatus of the very low definition then employed. With advances in technique that have been

IN this article some of the early experiments in colour television are described and details are given of the method employed in a recent demonstration. For this the combination of a cathode-ray tube and colour-disc was used at the receiving end.

made in latter years, it has become possible once more to turn to this form of scanning and make use of its many advantages over the normal straight and interlaced systems.

The system of scanning is such that a secondary field is formed, which is composed of a number, two or more, of primary scans interlaced. The secondary scan is then repeated a number of times, each time being displaced. As an example, let us take the scanning standard as used in the Dominion demonstration. This consisted of two 20-line scans intermeshed to form a 40-line scan, this being the secondary field. The secondary field was then repeated three times, each time being laterally displaced in order to interlace with the other fields so that a final scan of 120 lines was obtained. The following are the advantages that are claimed for this form of scanning over the conventional forms:—

(a) The frame frequency is consider-

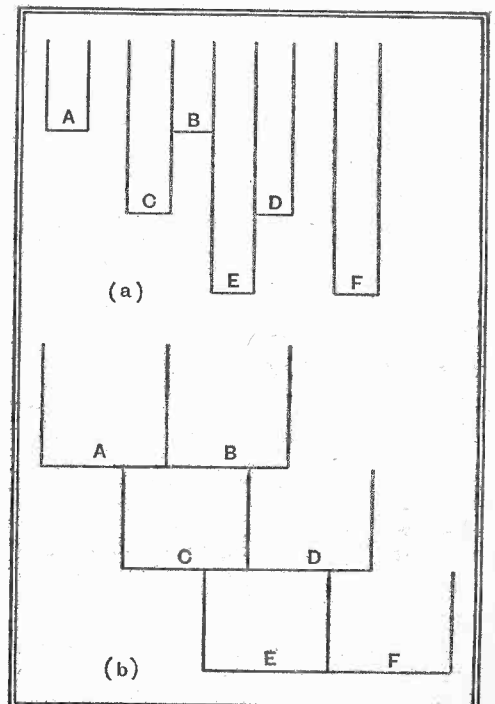

Fig. 2.—This diagram illustrates the arrangement of multi-mesh scanning.

Colour Television—

ably higher, since it is the frequency of the primary 20-line scan, resulting in a permissibly higher low-frequency cut-off for the communication channel.

(b) A reduction in flicker is effected.

(c) A considerable increase in light efficiency may be obtained by using a scanning spot such that the secondary scan completely fills the field. By doing this there is a relatively small loss in definition.

(d) It is possible to employ an optical system of great simplicity and exceedingly high efficiency.

The method in which the scan is arranged may be seen from Fig. 2.

The method employed at the Dominion can be most easily understood in conjunction with the diagram Fig. 3. At the transmitter there was a slow-speed slotted disc together with a high-speed mirror drum. The subject was floodlit and scanned by the combination disc and drum arrangement, the respective speeds of which were 500 and 6,000 revolutions per minute. The disc was provided with twelve slots arranged in the form shown in the diagram, alternate slots being covered with red and blue-green filters. The mirror drum used had twenty mirrors and threw an image of the scene being transmitted on to the disc, the combined action producing a 120-line scan composed in the manner described in the section dealing with multi-mesh scanning. The photo-electric cell used in this gear was one in which the sensitive surface was composed of rhabdium, a material which approaches the human eye in characteristic although infra-red had to be filtered out before good results could be obtained. This is due to the fact that different coloured objects may reflect the same amount of infra-red

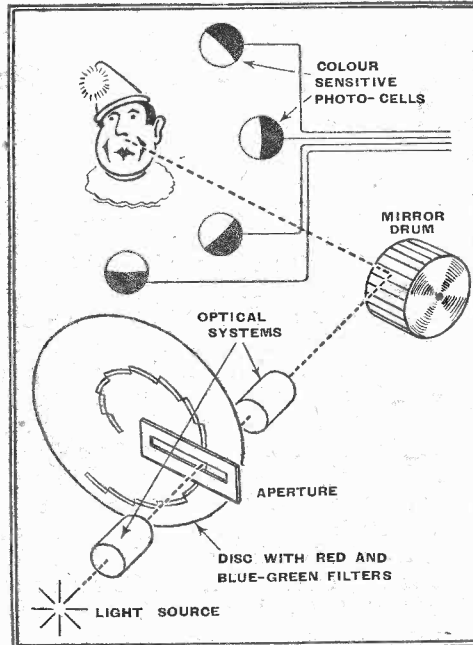

Fig. 4.—This drawing illustrates the transmitting system used in the recent demonstration. Spotlight scanning is employed.

described will be seen also in Fig. 3; the process of building up the picture being an exact reversal of that employed at the transmitting end. A high-intensity arc lamp replaces the photo-electric cell, and the light, after passing through the scanning disc, is modulated by a large Kerr-cell. The disc is identical to that used for transmission, so that when the red component of the picture is received the light is passed through its appropriate portion of the colour combination on the disc. The receiver screen is then scanned by a mirror drum, again of similar type to that employed at the transmitter.

The apparatus used for the demonstra-

tion. Fig. 4 will show the broad outlines of the arrangement in which, instead of an image of the subject being thrown on to the disc, the subject is scanned with light spots of varying colour according to the filters on the disc, the light reflected from the subject being picked up by colour sensitive cells. The drum used has thirty-four facets and revolves at a speed of 6,000 revolutions per minute.

The great advance that has been made in the apparatus is that a cathode-ray tube is used at the receiving end. Hitherto, the mechanical gear employed has been exceedingly cumbersome and prone to mechanical breakdown, whereas with the cathode-ray tube both these disadvantages have been done away with. The arrangement of the apparatus will be seen by reference to Fig. 5. A normal projection cathode-ray tube, similar to that employed in the apparatus installed in several London cinemas, may be used. In front of this tube there is arranged a disc with apertures covered by the same filters as those used on the transmitting disc. The picture viewed through this disc consists of a 102-line blue-green picture superimposed upon a 102-line red picture, the net result being a 102-line

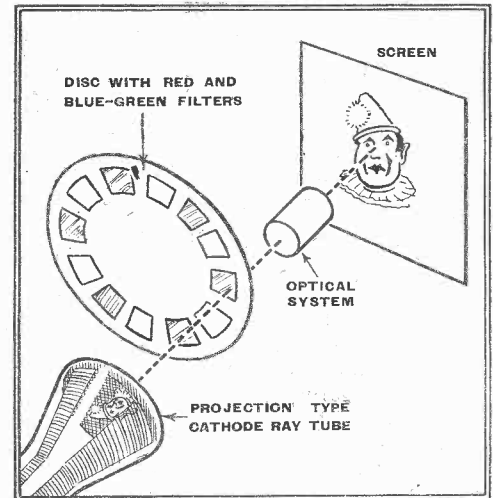

Fig. 5.—The receiving equipment is shown here. The colour-disc rotates in front of the cathode-ray tube.

picture in natural colours. The frame frequency of the picture is 16 2/3 per second. The size picture shown was 3ft. square approx. This does not constitute the limit of picture size, but was convenient for the size laboratory in which it was shown. Neither does the fact that the transmission was from the Crystal Palace, only two miles away, imply that the system has only a limited range.

It cannot be too strongly emphasised that the above-described demonstration must be looked upon as an experiment at present, and it can be stated with complete assurance that there is no likelihood of any alteration being made in the official service for some time to come. This does not, in the writer's opinion, mean that no use will be found for this system of colour television, since the demonstration showed clearly the potentialities of the apparatus for large screen work in cinemas and the like.

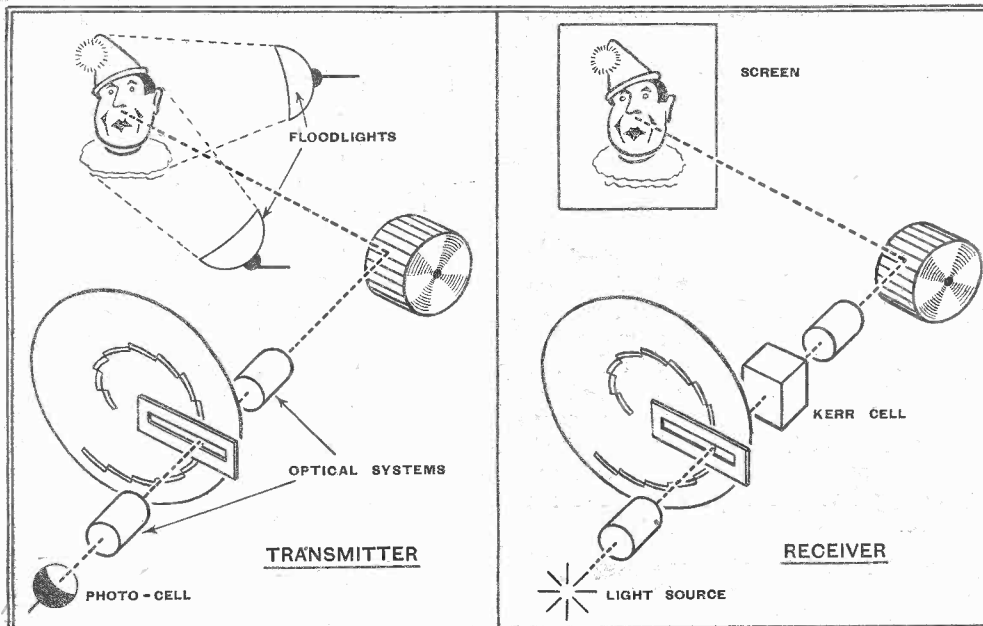

Fig. 3.—The layout of apparatus at transmitter and receiver for colour television when mechanical methods are used at both ends.

which would make them appear the same when a cell sensitive to that form of radiation was used. The receiver used in conjunction with the transmitter just

tion on July 27th, as far as the transmitting side goes, was similar to that just described except for the fact that the method of spotlight scanning was em-

The Berlin Show

GERMANY'S NATIONAL EXHIBITION REVIEWED

BY OUR SPECIAL
REPRESENTATIVE

A FEW months ago Adolf Hitler appointed Major-General Fellgiebel as Special Commissioner for the Standardisation of Communications Appliances. At the opening of this year's Berlin Exhibition, State Minister Dr. Goebbels gave out for the first time the general lines of this scheme as follows:—

"The formation of at most twelve industrial combines for the building of broadcast apparatus. Each of the combines will construct in future only the same types of apparatus. These combines will be formed by the grouping together of such firms as have the same financial foundations and already have connections with each other.

"The apparatus is to be developed as far as possible as AC apparatus with DC/AC converter devices, or as AC/DC 'universal' apparatus. Each combine will only turn out, in addition to the sets for political purposes, the following receiver types: (a) one highest-quality receiver, (b) one moderate-priced receiver, (c) one car receiver, (d) one local-station receiver with specially good musical reproduction and specially high output (maximum 9 watts), with provision for gramophone reproduction and wire broadcasting. The construction of single-circuit receivers is forbidden, except those for political purposes. The development of highest-quality receivers and also portable receivers will be permitted so far as export and domestic sales justify the development of such apparatus.

"As regards amplifiers, the following types are laid down: (a) one amplifier, output about 20 watts, (b) one with output of 120 watts, (c) one for about 500 watts. The amplifiers shall be able to satisfy all requirements of the defence forces, of community broadcasting (i.e., presumably in assembly halls, etc.), of community reception (i.e., presumably community-aerial reception in blocks of flats, etc.), etc.

"Component parts of all broadcast receivers to be of such types as may be used in other branches of wireless technique. The uneconomical fabrication of component parts is to be suppressed in favour of price-lowering mass production.

"To free the trade from the burden of the yearly recurring clearance of superseded types, a certain gradualness must occur in the standardisation. The limitation to the various prescribed types will be imposed within such an interval as will allow the trade sufficient time to dispose of their stocks of existing types.

"The suppression of interference radiated by electrical machines must be pressed further. This applies especially to the suppression, for short and ultra-short waves, of interference caused by all types of motor cars, including the "People's Car." In addition to these regulations for the standardisation of the industry, regulations are expected which will demand the use, even more than hitherto, of home-produced materials in the manufacture of apparatus."

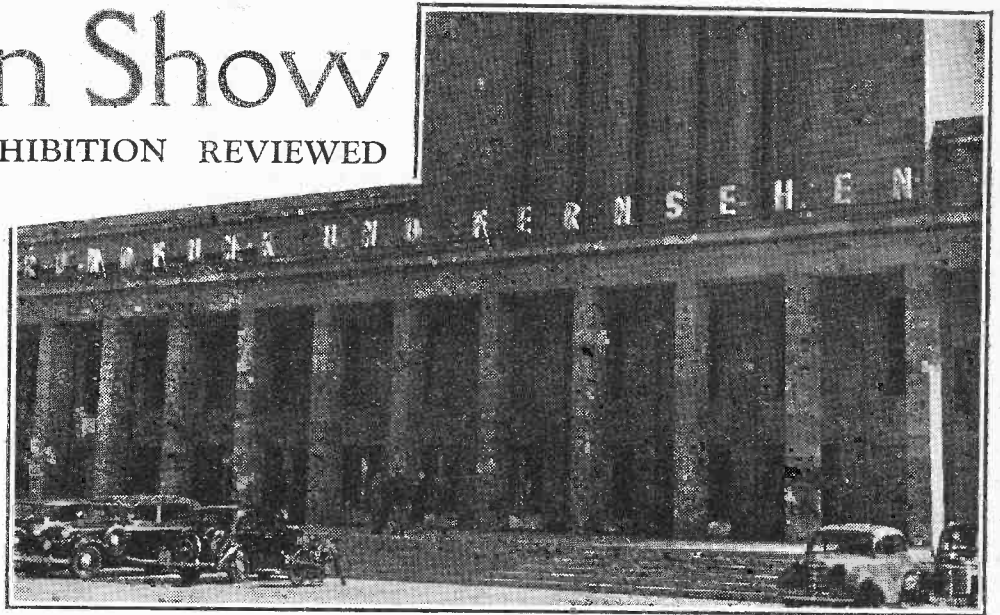

The opening day of the Exhibition also produced some statements by Dr. Goerz on the development of German broadcasting in the past year. The number of listeners increased by 20 per cent. to 12,580,000. In the 1937-38 season about 1.1 million marks worth of broadcast receivers were sold; in 1938-39 the amount was 1.66 million marks. In "common-specification" receivers (such as the "People's Receiver" and the "German Small Receiver" or "D.K.E.," made by all firms to the same specification) the turnover rose from 576,000 to 1,400,000 sets; this unexpectedly large rise was chiefly due to the sale of the "D.K.E.," which amounted to 917,000.

The total turnover has increased since the season 1932-33 from 1 million to 3 million receivers. This increase has not, the speaker pointed out, completely fulfilled all the requirements of the Four-Year Plan, but this will be put right when Major-General Fellgiebel's regulations come into force. The new scheme will affect the development of next year's apparatus; already certain steps have been taken, such as the reduction to 48 per cent. of the number of receiver types as seen at this year's Exhibition, the reduction from 66 to 23 per cent. in the number of receiving-valve types, from about 1,000 types of resistors to 17, and so on.

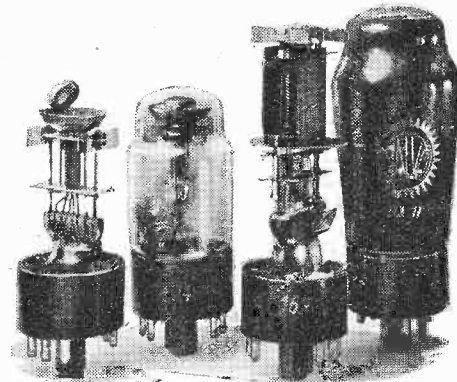

The new valves EM 11 and ECL 11. In the latter (right), from top to bottom can be seen the tetrode system, the triode system, the screening of the connections, and the constricted foot.

The average price of the 1.66 million "proprietary mark" receivers sold in 1938-39 was 226.27 RM, while that of the 1.40 million "common specification" receivers was 43.50 RM. As for valve prices,

the previous year saw a decrease of 10 per cent. in these, but this year brought a further fall of about one-third in the price of replacement valves only; not of those delivered with a receiver. This cut did not affect the valve industry too severely, since the number of replacement valves in Germany is only a quarter of the number supplied with new receivers.

The distinct German style in receivers, developed during recent years, has attained great popularity and is being continued. Cabinets for the cheaper sets are made mostly of plastics, with wood linings inside to ensure good bass-note radiation. Tuning scales for the short-wave range are being sub-divided as much as possible, and last year's popular horizontal type of scale is being retained. The audio-frequency range has been extended down to 30-40 c/s; new loud speakers with larger, lighter diaphragms and very thin leather suspensions are being developed for this purpose. Siemens have provided their "Chamber-Music Receiver" with five loud speakers, thus ensuring a very wide frequency response. Last year the accentuation of bass frequencies was in some cases carried too far; this year it has been reduced. Negative feedback has been improved. Automatic volume control has also been improved.

The problem of differing mains supplies has been solved by about half the firms this year building only AC sets, in which DC/AC converter units can be inserted when DC mains have to be used. The other half of the manufacturers are building "universal" AC/DC sets, being greatly helped in this by the introduction of a quite new series of steel "all-current" valves, known as the "U" valves. These have a heating current consumption of only 100 mA compared with the 200 mA of the "C" and "E" types. The reduction of heating current, with corresponding raising of voltage, enables the power for heating to be better utilised; it can by these means be reduced from 44 to 22 watts. Thanks to this, AC/DC sets have been able to dispense with the "current-economising" circuits which were so prominent last year, and which are, in fact, still widely used this year in AC sets, even superheterodynes.

The new valves include also the ECL 11, a new multiple valve with a triode as LF amplifier and a tetrode as output, and the EM 11, a new "magic eye." These valves enable a three-valve superhet to give the same performance as a last year's four-valve

The Berlin Show—

superhet, while the multiple valve costs no more than the simple valve. The new "magic eye" overcomes the difficulty experienced with the older type; the single luminous-sector system may work well on strong signals but poorly on weak ones. The new tuning indicator has two such systems, at right-angles to each other, the one having a suitable sensitivity for strong signals and the other for weak. The EM 11 does not include an amplifier system, as its predecessor did.

Then come the "U" series mentioned above; the UCH 11, a new multiple-system valve (triode-hexode), the UBF 11 (double-diode, variable-mu pentode), the UCL 11, an AC/DC valve with the same characteristics as the ECL 11 just described, and, finally, the UY 11, an indirectly heated half-wave rectifier.

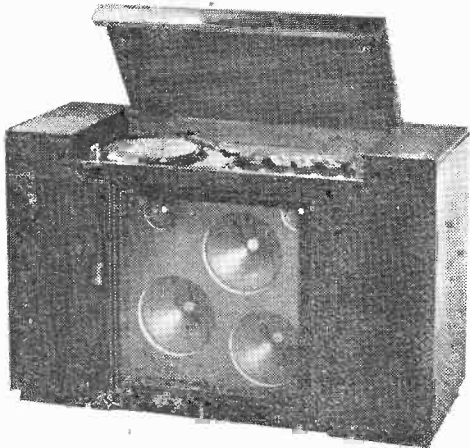

more varieties than ever) has been improved particularly by the introduction of a new loudspeaker with increased frequency range. Special notice is directed to the

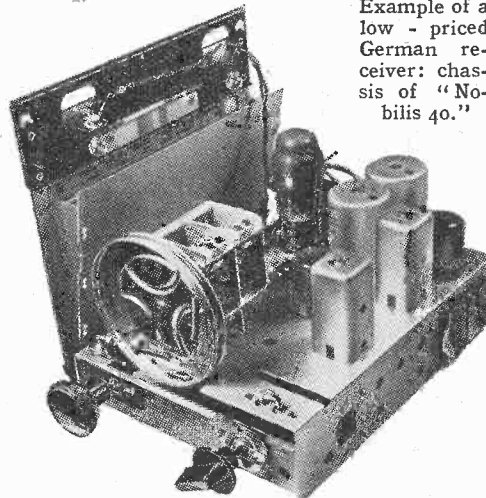

Example of a low - priced German receiver: chassis of "Nobilis 40."

new single-circuit receivers of Siemens and Telefunken, both of which have a short-wave band, with HF amplification provided by the output valve; in this way, short-wave reception is given an additional amplification of about 10.

(Left) Siemens "Kammermusik-Gerät II," comprising a superhet receiver with 13 valves, 4 wave ranges (2 of which are short waves) and 5 loudspeakers.

(Right) Push - button tuning panel as employed in Telefunken superhets.

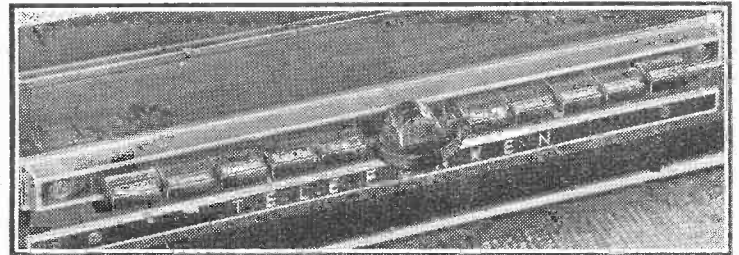

Several German manufacturers have this year adopted the plan of separate chassis for receiver and mains unit to save weight in raw materials. Lorenz, to reduce costs, has produced a standard chassis applicable to several types of receiver (by mounting thereon more or less component parts);

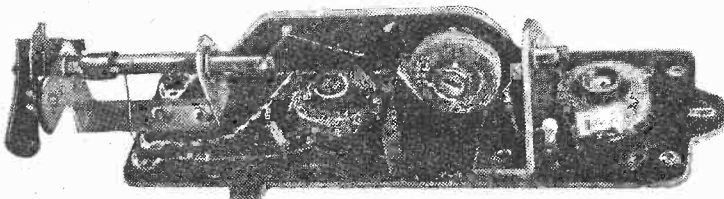

(Above) The new adjustable three-circuit IF band filter in the Körting "Amatus 40" and "Dominus 40."

(Right) Unit system chassis in Körting "Dominus 40": separate chassis for high-frequency section.

moreover, with this firm the components are so widely standardised that they can be used for various receiver types.

A very important improvement has been brought out by Körting. This firm has produced a very good adjustable three-circuit intermediate-frequency band filter, which allows the pass band to be regulated within wide limits.

Taking the various types in order, the single-circuit receiver (of which there are

The two-circuit receiver (no longer very strongly in evidence) remains much the same as last year; the built-in regenerative coupling is no longer adjustable.

Both one - circuit and two-circuit types use metal valves almost exclusively.

Thanks largely to the use of the new multiple - system valves, superheterodyne receivers

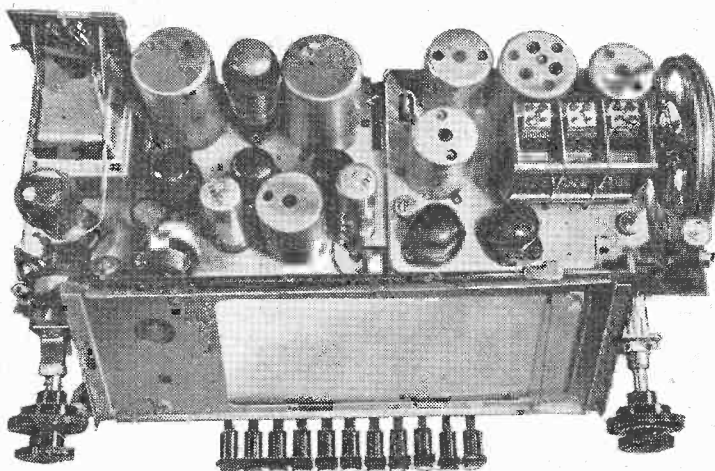

have had their prices reduced by 20-25 per cent. (four-valve superhet, 1939-40, price 186 RM compared with 205 RM in 1938-9). The better sets all have the new EM 11 as a tuning indicator. Even more popular than last year is the use of a

three-section condenser, since the extra signal-frequency tuned stage still has its advantages even with an IF of 468 kc/s. The extra circuit is omitted when the receiver is push-button tuned. In general, the six-circuit superhet is found with one signal-frequency circuit, and the seven-circuit type with two. In the most ambitious sets still more circuits are used. Saba this year uses eight circuits in most of their receivers, the first IF filter being a three-circuit one. The same applies to Körting. Telefunken strikes a new note in the "Super 944W," a specially cheap superhet with only four circuits. It has only a single IF band filter, the necessary selectivity being obtained by providing the IF amplifier with reaction. The set includes only the ECH 11 and the ECL 11 multiple valves in addition to the rectifier.

Most German superhets are provided today with some form of push-button tuning. This will be dealt with later on.

Körting has a radiogramophone this year which uses a sound film in place of disc records.

As regards battery-driven receivers, this year shows many battery-driven superhets provided with short-wave reception.

Last year push-button control of superhets was of the motor-driven type for coarse

tuning supplemented by automatic fine tuning by special valve circuits. Although the automatic tuning correction was found to be unnecessary, and the motor-drive system persists in a few high-quality superhets, it has not progressed as much as seemed likely from last year. On the contrary, Germany to-day uses chiefly two systems: the mechanical system, in which the pressure of a button moves the tuning condensers to the required setting, and the pre-tuned system in which circuits tuned by means of movable iron cores are selected by switches. In one case the tuning circuit has only one inductance, different fixed condensers being connected in the circuit for each wavelength.

In one receiver (Sachsenwerk "Full Automatic") only push-button tuning is provided; it is therefore particularly cheap. All the others have manual tuning as well as push-button, as before. In every case the listener can adjust the push-buttons to correspond to the stations of his choice. The number of buttons varies between 6 and 10. With some makes, certain buttons can only correspond to medium-wave stations, others to long-wave stations; while other firms arrange that any button can be used for either medium- or long-wave stations.

Purely mechanical systems are employed, for example, by Siemens and Philips. In the Siemens system the pressing of a button moves a toothed segment geared to the variable condenser. During the pressing of the button the loud speaker is cut out of circuit. There are six buttons, which can be set for medium- or long-wave stations at will. The setting of a button to a station is accomplished by hand-tuning to the

The Berlin Show—

desired station and then giving the button a turn to the left (releasing a catch), pushing it in, and finally twisting it to the right. It is then set for the desired station.

The Philips device is somewhat more complicated; one distinguishing point is that no rotating condensers are used, their place being taken by three special sliding condensers (strips wound into spirals, one sliding into the other).

Special arrangements are made to enable the listener to calibrate his push-button tuning. Telefunken accomplish this in the following way: The intermediate AF amplifier valve (or the output valve, according to the circuit of the receiver) can be switched so as to act as a signal generator for calibration purposes. The ordinary

circuit can, for the sake of calibrating the separate push-button tuning circuits, be adjusted separately. Thus the oscillator is set in action and the input circuit tuned to it.

Mende, and Ehrich and Graetz, are the only makers who use trimmer condensers for adjusting the push-button circuits, and they employ them only for the input circuits, the oscillator circuits having permeability tuning. In all push-button superhets the first input circuit is disconnected when the set is changed from manual to push-button tuning. In all sets the push-button systems form a complete unit in themselves.

While the exhibitions of last year and previous years showed different television receivers from all five television firms, this year the German television industry, in collaboration with

the Reich Post Office, decided only to show the new Unit television receiver. This was after the German P.M.G. had proclaimed that this year television receivers ought to be available on

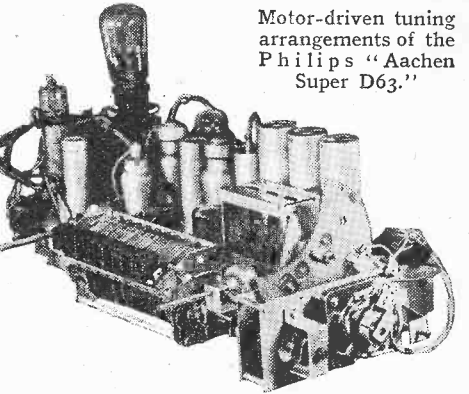

Motor-driven tuning arrangements of the Philips "Aachen Super D63."

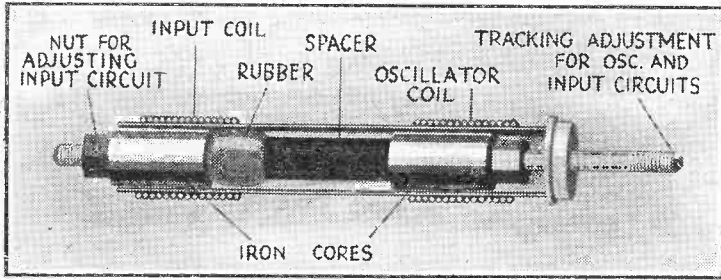

(Above) Iron-cored adjustable inductances for Telefunken push-button superhet.

(Right) Six-station push-button tuner of Siemens-Super. The pressing of a button moves the toothed segment and rotates the condenser-spindle through an angle determined by the adjustment of each button. A switch interrupts reception while a button is being pushed.

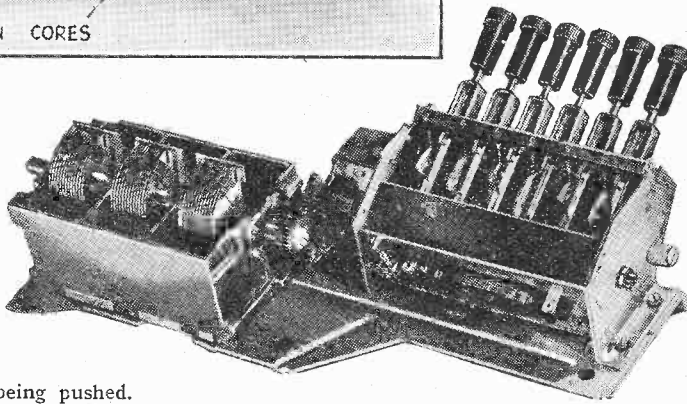

oscillatory circuits for hand tuning then serve as oscillator circuits; the manual tuning knob is turned until the pointer is at the desired station, and the receiver then responds to the signals thus locally produced. The button which is to be calibrated is then pushed in, and the inductance of the iron-cored coil associated with that button is varied until the local signals are heard. The local oscillator is then switched off and the fine tuning is carried out by listening to the actual station. The "magic eye" assists in the final critical adjustment.

Blue Spot employs for calibration purposes the oscillator normally present in the set. Whereas in most makes of receiver the input circuit coil has a fixed coupling to the oscillator coil, with Blue Spot the input cir-

cuit can, for the sake of calibrating the separate push-button tuning circuits, be adjusted separately. Thus the oscillator is set in action and the input circuit tuned to it.

Mende, and Ehrich and Graetz, are the only makers who use trimmer condensers for adjusting the push-button circuits, and they employ them only for the input circuits, the oscillator circuits having permeability tuning. In all push-button superhets the first input circuit is disconnected when the set is changed from manual to push-button tuning. In all sets the push-button systems form a complete unit in themselves.

While the exhibitions of last year and previous years showed different television receivers from all five television firms, this year the German television industry, in collaboration with the Reich Post Office, decided only to show the new Unit television receiver. This was after the German P.M.G. had proclaimed that this year television receivers ought to be available on

manufacture was undertaken by the Fernseh A.G., Radio A.G. Loewe, C. Lorenz A.G., Tekade, and Telefunken. The new Unit television receiver was built on the following lines: (a) An output of 10,000 sets, to be delivered in time for the 1939 Exhibition; (b) no medium- or long-wave receiving facilities, only provision for ultra-short wave sight and sound reception; (c) the greatest possible adaptability to "wireless" and "wire" reception.

The number of the first series was based on the consideration that, for the present, Greater Berlin would be the only sales zone. The decision to omit medium- and long-wave reception was due to the desire for the lowest possible price for the first series, coupled with the assumption that in Greater Berlin everyone who would be interested in a television receiver would already possess a broadcast receiver.

The receiver had at all costs to be ready for the 1939 Exhibition. That left very little time. Consequently it was essential to cut out extensive development work; previous experience must be relied on, and luckily there was already plenty of this.

The least difficult decision was the choice of the circuits for the amplifier component. All the firms had in past years turned out

Push-button tuning system ("electric brain") of the Sachsenwerk "Vollautomat."

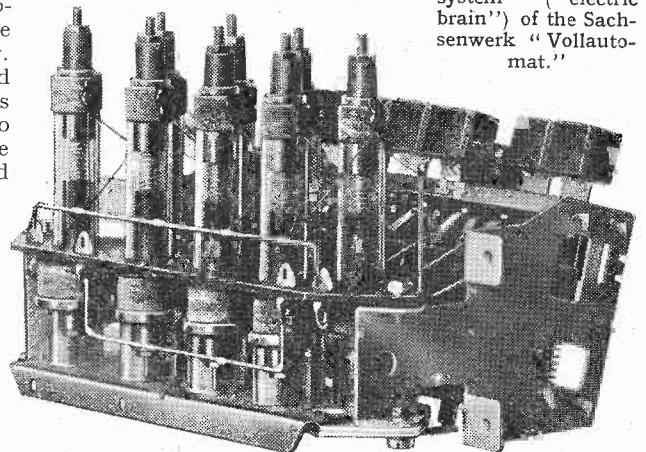

(Left) Details of permeability tuning system in Telefunken sets. By the action of the push-buttons a special oscillator circuit and preliminary circuit is switched in for each station.

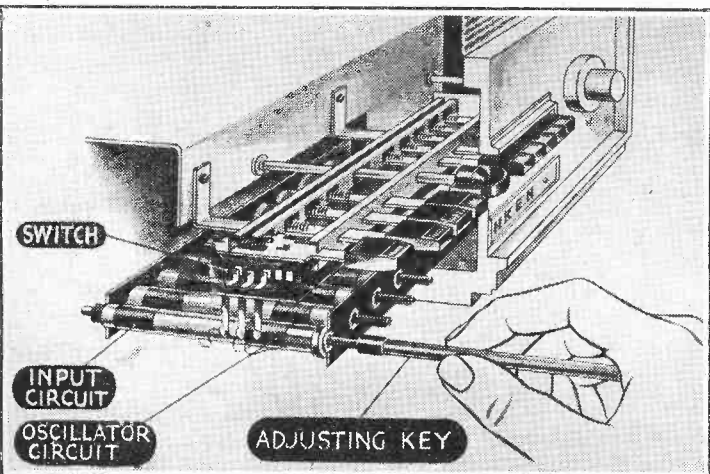

receivers of the superhet type. This proved circuit was, therefore, retained, an ECH 11 being chosen as mixer, preceded by one input valve and followed by a double IF amplifier stage, a detector, and finally an LF amplifier stage. All the amplifier stages are fitted with "steel" (metal) valves, the EF 14. The tuning circuits are given a fixed adjustment to the local Berlin station,

The Berlin Show—

the input valve and its associated circuits being made into a small interchangeable assembly unit which an owner who changes his locality can replace by another, at low cost, so as to tune to another station. The sound amplifier is on usual lines. It branches off the above-described amplifier at a point between the mixing stage and the first IF amplifier stage, through a filter circuit.

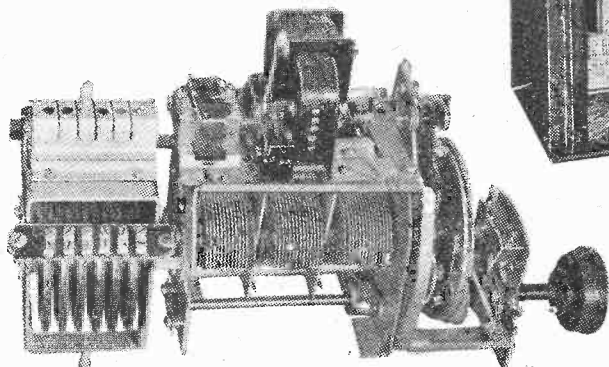

(Above) "Unit" television receiver: the four knobs control contrast, intensity of image, sound volume, and image sharpness.

(Left) Push-button tuning system of Blue Spot Super.

The most interesting part of the receiver is undoubtedly the scanning unit, which is designed to be as simple and cheap as possible. It contains only two valves, of a type specially developed for it. To reduce the whole cost of the receiver, the scanning unit has been called upon to provide also the 6,000 volts high tension for the cathode-ray tube; this is done in the following manner. When, in a television receiver, the spot of light flies back, at the end of each line, to the beginning of the next line, very high undesired peak voltages are produced in the winding of the line transformer. These peak voltages are now filtered out, rectified, and used as anode supply for the cathode-ray tube. Since their frequency is 11,025 c/s, they require far less smoothing apparatus than when the mains supply is used to produce the anode voltage.

The voltage supply for the picture amplifier, sound amplifier, and scanning unit is provided by one common transformer through two separate rectifiers, one for vision and one for sound. This is necessary in order that, later on, during pauses in picture transmission, the ordinary broadcast programmes of the Berlin broadcasting station and the Deutschlandsender may be heard on ultra-short waves through the sound portion of the television receiver, without the picture portion having to be kept running.

The cathode-ray tube has a 20 x 23 cm. screen (nearly flat) and is only 39 cm. long. This enables the whole receiver to be kept very small. The screen is at the right hand of the front of the receiver, and by its side is the loudspeaker. This arrangement gives a symmetrical appearance to the front, and also leads to a very compact and economical design of chassis. The adjustment is by four knobs, for picture contrast, picture amplification, picture sharpness, and sound volume.

The following facts regarding the television are of interest:—Cabinet size: height, 37 cm.; width, 65 cm.; depth, 38 cm. Weight about 33 kilogrammes. Power consumption: Picture and sound together about 185 watts. Sound alone, about 60 watts. Valves: Five of type EF 14; one each of types ECH 11, EF 11, EBF 11, EL 11, EZ 11, RFG 5, AZ 11 and AZ 12; two of type ES 111.

Some details of the cathode-ray tube have already been given. Its focusing is magnetic, as is also the deflection in both directions. Modulating voltage for 100 microamperes, about 20 volts.

A cable having a characteristic impedance

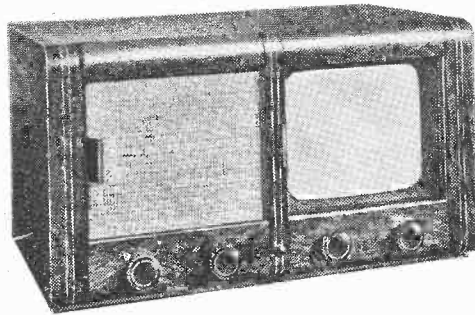

of 130 ohms is used as an aerial feeder. In this way, together with the pre-amplifier valve in front of the mixing stage, an input sensitivity of 200 microvolts is assured.

The manufacture of the set for the Fernseh A.G. has been undertaken by the firm Blaupunkt (Blue Spot), Berlin.

Five-metre DX

BAD WEATHER INTERFERES WITH "GW" CONTEST

THE period straddling August Bank Holiday appears to have been a quiet one so far as 56 Mc/s activity was concerned, at least the writer found it so on the few occasions when any listening was done.

Those interested in this band may be glad to know that G2OD, one of the most indefatigable of the pioneer experimenters, is again active, but now transmitting from a temporary station located near Worthing, Sussex.

GW6AA at Colwyn Bay, North Wales, sends a report of the activities of this station during the "GW Trophy" field day on July 30th last. A portable station was erected on Snowdon as previously reported, but owing to unprecedented bad weather for this time of the year, it was impossible to erect the high-gain beam aerials on which many months of experimental work had been lavished. It is learned that particulars of G8ST's reception from Snowdon are being requested and if these check with GW6AA's log, as it is thought they will, it should prove the longest reception report of the day, being about 185 miles.

Contact was effected with G6CW Nottingham at 124 miles and also with G8JVP located 4½ miles north of Leek, Staffordshire and at 1,600 feet above sea level. Signals were R9 in both directions and the distance would be 85 miles.

The information regarding G8JVP'S position is imparted by G6CW who was also very active during this week-end and reports that

conditions were good for five-metre communication between 6 pm GMT on Saturday, July 29th and 9 am on Sunday, but deteriorated later.

Between 5 pm GMT on the Saturday and 12.20 am on the following day G6CW worked G2MV, 2MR, 2NH, 2ZVP(Arundel), 6DH, 6GS, 6LK, 6QZ, 6VX, and 8OS. The longest distance station was G2ZVP at 160 miles.

Owing to the favourable location of G8JVP contacts were made with G6DH at 170 miles, with G2MV and 6VX at about 145 miles using only 8 watts input.

Between July 31st and August 4th G5CD at Hendon heard the Belgian station ON4NA in Brussels on three occasions. Best reception was R8(CW) and although G5CD called this station several times, immediately after each of which ON4NA was again heard, apparently some confusion arose regarding the designation of the G station, as the call sent out was not that of G5CD. ON4NA was reporting reception RST 459 so it seems that contact had been established. Confirmation is expected in due course.

On all occasions the time was just after 9.30 pm GMT and the frequency is about 57.3 Mc/s. Further reports of reception and contacts with Continental 56 Mc/s stations will be welcome.

Five-metre Receivers

It is always interesting to have details of the receivers now being used for five-metre reception. Straight sets appear popular, but there are obvious advantages in a superhet. If one has a good communication set the addition of a converter is worth while considering. It is learned that one such unit recently put into commission consists of an Osram Acorn RF stage, with regeneration, feeding into an X65 frequency changer and followed by a KTW63 as 1st IF stage tuned to 4 Mc/s. A low-impedance link couples this to the input of the communication set which is of course tuned to 4 Mc/s.

The measured sensitivity of this arrangement is stated to be of the order of 0.5 microvolt. As would be expected the noise level is inclined to be high but at slightly reduced sensitivity it will bring in almost every signal that can be resolved into a readable form, but without an unduly high background. We are indebted to G5CD for this piece of information, though the converter is one used by another station. G2MC.

VOIGT LOUD SPEAKERS

Demonstrations During the Show Period

AS in previous years, Voigt Patents, Limited, are arranging to give demonstrations of their reproducers in conjunction with Lowther receivers and amplifiers at a place convenient for visitors to Olympia. The room is over the premises of Messrs. Westby's, 2, Beaconsfield Terrace Road, and is best reached by leaving the Exhibition through the exit leading into Blyth Road.

There will be two sessions daily, from 11 a.m. to 1 p.m., when gramophone records will occupy most of the time, and from 3 p.m. to 10.30 p.m., which will include regular reception periods for the Promenade Concerts. It is hoped to demonstrate an experimental long-wave tuner designed to refute the widely held opinion that reception from Droitwich must necessarily be inferior to that of stations working on lower wavelengths.

NEWS OF THE WEEK

INTERFERENCE SUPPRESSION

Marked Apparatus Soon Available : European Investigation

IT was announced in *The Wireless World* of April 13th that the British Standards Institution had registered a special certification mark which could be used under licence by manufacturers of electrical appliances which are inherently free from radio interference or which are fitted with suppressors so that the interference is within the limits laid down in Specification 800.

The Institution now announces that it is prepared to receive applications for licences for the use of this mark, and full particulars may be obtained on application to the Director, British Standards Institution, 28, Victoria Street, London, S.W.1.

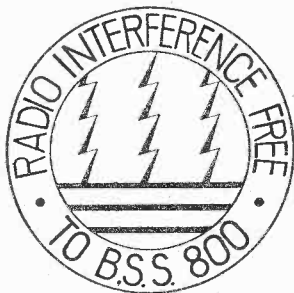

It can therefore be expected that in the course of a few months electrical apparatus bearing the mark which is reproduced above will be available to the public. This is certainly one step towards interference-free reception, but only one short step, for until legislation is given on this all-important matter there will be little change in the present position. In the Editorial Comment of August 3rd we wrote that it was understood that the protracted delays in legislation are due to the difficulty in reconciling conflicting interests and to assessing, on a precise quantitative basis, the nature and amount of permissible interference from various sources.

The Wireless World has repeatedly urged the need for a stop-gap Bill to establish the general principle that to knowingly cause interference is an offence.

On the Continent

In accordance with the recommendations of the Special International Committee on Radio Disturbances, the Belgian Central Electricity Laboratory recently constructed an instrument for measuring the peak voltages of electrical disturbances at their source. Similar

instruments are to be put in service immediately in some twenty European countries so that measurements may everywhere be obtained by the same methods, thus rendering it possible to frame international regulations for the elimination of interference.

France appears to be doing a good deal in the way of campaigning against interference. French engineers are being provided with 300 detectors of a new pattern. These are very sensitive lightweight portable four-valve superhets. By the end of this year ninety laboratory cars will also be in use in France for investigation purposes and tracking down offenders.

HIGH-QUALITY REPRODUCTION

Lecture at Olympia

THE programme of Popular Technical Conventions to be held at Olympia in connection with the Radio Exhibition is given elsewhere in this issue. It will be seen that each of the four meetings has its own particular theme: General Technical Topics, Television, Short Waves, and Quality Reproduction.

Those whose interest lies mainly in the last-mentioned subject should make a special note of August 29th, when at 3.30 p.m. Mr. P. G. A. H. Voigt will open the discussion on "Quality and What it Means To-day." It is hoped that he will bring with him apparatus to demonstrate his points.

MONTREUX DIALS

Set Manufacturers' Decisions

RECEIVERS purchased at the British radio shows this autumn will not be fitted with tuning arrangements calibrated to the Montreux Wavelength Plan, which comes into operation on March 4th next year.

The sub-committee of the Set Makers' Section of the Radio Manufacturers' Association, after careful consideration of the situation which will arise when the Plan becomes operative, has recommended that all sets supplied by manufacturers after January 1st shall either be fitted with Montreux-calibrated scales or may be supplied with a new scale as a spare at the time of purchase or free of charge when required.

New scales for 1939 models sold during this autumn will not be available until January 1st, when a minimum charge of 2s. 6d. (fitting extra) will be made.

New Scales for Old Sets

The question of supplying new scales for old receivers has, of course, arisen, and whilst the majority of manufacturers are not in favour of supplying these for sets of earlier vintage than the 1937 exhibition, it was agreed to recommend the following minimum charges: For sets current between the 1938 and 1939 exhibitions, 4s.; and for those current between the shows of 1937 and 1938, 5s. 6d. These prices are irrespective of material or type of scale.

Regarding automatic tuning receivers, it is recommended that, whilst manufacturers are

free to fix charges or minimum charges to be made by dealers for returning such sets, there shall be no advertising of free change-over or returning.

These recommendations will form the basis on which manufacturers will make their individual arrangements.

Commenting on the proposals, *The Wireless and Electrical Trader* says: "It should be remembered that the radio trade is not responsible for these wavelength changes and for the inconvenience that will be experienced by listeners, and for that reason it is common sense no dealer should carry out scale replacements and fittings on old sets except at a fair and reasonable charge."

WIRED WIRELESS

Use of Electricity Supply Mains

THE statement by the Postmaster-General on the use of the electric light mains for wired wireless distribution, to which the Editorial Comment in this issue refers, was made in reply to a question in the House of Commons on July 27th.

The question, asked by Sir M. Sueter, was, whether the system of wire broadcasting by electric mains was being investigated fully by the technical officers in the P.M.G.'s department to ascertain if the technical difficulties could be overcome to enable this system to be put into operation on many power cable networks in this country.

In reply, Major Tryon said that proposals for the distribution of broadcast programmes by means of electricity supply lines were under consideration by his department in consultation with the Ministry of Transport and the Electricity Commissioners and that a meeting was to be held with representatives of the electricity supply associations at which the technical and other aspects of the scheme would be discussed.

GAUMONT-BRITISH AND TELEVISION

"Cinema Television of Immense Value"

SPEAKING at the twelfth annual general meeting of the Gaumont-British Picture Corporation, which was held at the New Gallery Kinema, London, last Thursday, Mr. Isidore Ostrer, the chairman, said that their holding in Baird Television was considered to be of great importance to the future of the Corporation. "We are satisfied," he said, "that the period of development in the home receiver side of the business is now past, and that the popularity of this new art can be assured."

Referring to the large-screen television reception of the homecoming of their Majesties from

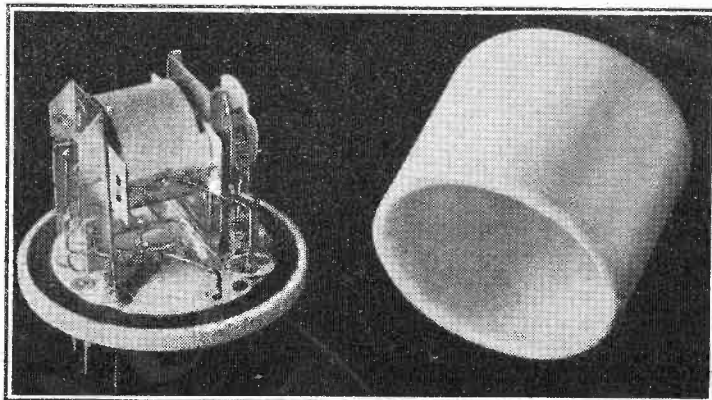

A CERAMIC ENVELOPE and base have been used in the construction by Hescho of this latest German valve of the same size and shape as the all-metal type. The high-frequency screening, in types where it is needed, is effected by spraying a thin layer of metal on to the inside of the Calit cover.

News of the Week—

Canada, he said, "When such an event can be shown at the time of its happening, there can be no room for doubt as to the future of television, and we take the most definite view that large-screen television will become of immense interest and value to the cinemas in this country."

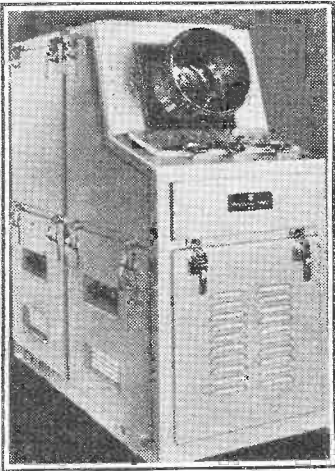

GERMAN CINEMA TELEVISION. At a Post Office in the north of Berlin has been installed one of these Fernseh projection television receivers. The hall, which has seating accommodation for 600 people, is fitted with a special screen measuring 3 x 3.6 metres. The receiver, which projects the picture on to the front of the screen, uses a lens with a focal length of 40 cm. and an aperture of $f1$.

GERMAN TELEVISION REORGANISATION

UNTIL recently the German Post Office was responsible for the entire technical operation of the television station, including the cameras, lighting and transmitter where post office staff was employed. Difficulties, however, arose from the frequent changes in the personnel due to men being removed to other Post Office departments.

The German Post Office Television Company has, therefore, been formed for the sole purpose of providing studio staff and equipment for the television stations. Where the signal leaves the studio the Post Office proper becomes responsible for it.

This means that three organisations are concerned in the television transmissions for the broadcasting organisation, Reichs Rundfunk Gesellschaft, is responsible for the provision of the performers and programme management.

Due to a misunderstanding we stated a few weeks ago that the German Post Office Television Company had taken over the control of the Italian television transmitters.

THE BALLOON BARRAGE

Ultra-Short-Wave Interference
THE effects of the balloon barrage on ultra-short-wave reception which have been stressed in the lay Press have not taken the Air Ministry by surprise. Several months ago balloons were put into the air for the main purpose of determining their influence on wireless reception. Reports from different parts of London now show that the disturbing effect on television reception is widespread.

Reflections, sometimes triple images, have been caused by balloon wires situated as far as half a mile away from the receiver. From Dulwich (South London), where the field strength of the television transmitter is so great that a receiver has continued to work satisfactorily with the dipole aerial disconnected, a viewer reports constant frame slip caused by delayed reflection from the anchor wire of a balloon a quarter of a mile away.

**FROM ALL
QUARTERS****Australian Naval Radio**

Ex-R.N. telegraphist ratings, who have been less than five years out of the service are being given the opportunity of joining the Royal Australian Naval Shore Wireless Service which has been established to man the wireless and DF stations at Canberra and Darwin and the DF station at Fremantle. Engagement will be for six years, with subsequent re-engagements of six years up to the age of 55. Applications should be addressed to the Captain, H.M. Signal School, Portsmouth.

R.A.F.C.W.R.

THE Civilian Wireless Reserve of the R.A.F., formed ten months ago, is in process of being transferred to the R.A.F. Volunteer Reserve, and members have received forms requesting them to re-enrol in the latter organisation. Other radio enthusiasts interested can obtain a copy of the form, Air Ministry Pamphlet 81C, on application to Adastral House, Kingsway, London, W.C.2.

Obituary

THE death has occurred in Moscow of Professor M. V. Shufelkin, a member of the Academy of Sciences of the U.S.S.R. and Chief Engineer of the Department of Communications in the Red Army. He gave all the principal courses in radio at the Military Electro-Technical Academy and at the Moscow Electro-Technical Institute of Communications.

Mr. Elwelyn Birchall Atkinson, who was a well-known figure in the electrical industry, died on August 9th at the age of 75. He was president of the I.E.E. in 1920 and a past chairman of the Council of the Royal Society of Arts.

COMMONS ACOUSTICS**Plea for PA Equipment**

IN response to an invitation from a Parliamentary reporter, Mr. Herwald Ramsbotham, First Commissioner of Works, spent an hour in the Press Gallery of the House of Commons to test for himself the audibility, or inaudibility, of Members of Parliament.

An earlier request for the installation of public address equipment was rejected on the score that it would also amplify undesirable asides.

The invitation, which was written in Latin, as was also the reply, contained the following:—"In the year 1850 Lord John Russell, the Prime Minister, and the leader of the Opposition, Sir Robert Peel, came up to the Press Gallery (when the new buildings were opened). Having heard, or rather failed to hear, the debate, they decided to close the whole House of Commons for two years while a false roof was installed to improve the acoustics."

Northern Radio Show

It is announced by *The Manchester Evening Chronicle* that the sixteenth of the series of North National Radio Exhibitions, which, with Provincial Exhibitions, Ltd., they have organised, will be opened on September 26th by Sir Stephen Tallents, the B.B.C. Controller of Public Relations. The Exhibition, which will run until October 7th, will once again be held in the City Hall, Manchester.

Bristol Radio Exhibition

THE ninth consecutive Bristol radio exhibition will be opened at the Coliseum on September 6th next by Reginald Foort, the former B.B.C. organist.

Ideal Home Exhibition

THE *Daily Mail* Ideal Home Exhibition for 1940 will be held at Olympia, London, from April 2nd to April 27th.

Radio-Andorra

ANDORRA, the pocket State in the Pyrenees, now has a powerful broadcasting transmitter. Last week the Minister for Public Works officially opened the station, the masts of which are nearly 5,000 feet above sea level. Its programmes, which will be in three languages—French, Spanish and Catalan—will be radiated on 410 and 25.35 metres. It is reported that its medium-wave power will be 350 kW.

Marine Radio in Eire

THE maintenance of wireless installations in ships calling at Dublin and other matters relative to marine wireless in Eire will be dealt with at the new offices of the Marconi International Marine Communication Company, 49, North Wall, Dublin.

Chinese Radiophone Service

It is announced from Chungking that the new radio-telephone service between that city and Hong Kong, a distance of nearly 700 miles, will be opened shortly.

Marine Electrical Equipment

THE experience gained by the International Marine Radio Company in the production, operation and maintenance of marine radio equipment has resulted in the opening of a Marine Products Department, which will deal exclusively with the supply and maintenance at sea of a wide range of electrical apparatus.

Training Operators and Engineers

COURSES of instruction for radio engineering and television, as well as for prospective marine wireless operators, are described in a booklet recently issued by the London Radio College, 43, Grove Park Road, Chiswick, London, W.4.

Radio Engineers

THE British Institution of Radio Engineers, the headquarters of which are Duke Street House, Duke Street, London, W.1, has issued a booklet outlining the aims and objects of the Institution and the regulations governing membership.

RADIO-EQUIPPED PA CARS were used during the recent Tour de France cycle race. By means of short-wave transmitters and receivers the two vehicles shown were able to exchange information on the progress of the race up to a distance of 12 miles.

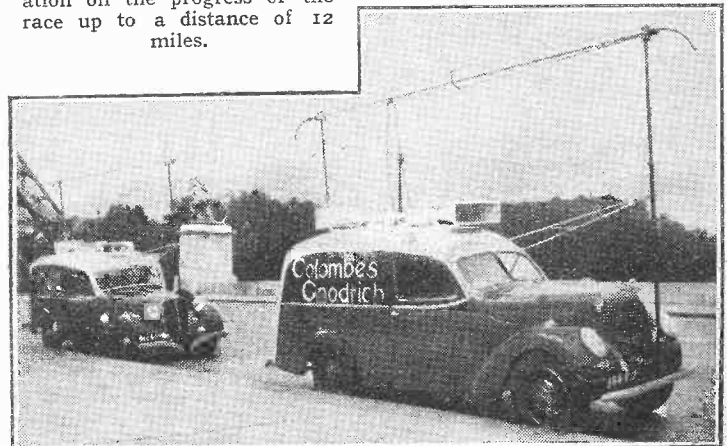

Modern Detector Circuits

USING A CATHODE-FOLLOWER BEFORE A DIODE

By W. T. COCKING

IN this article it is shown that the disadvantages of the diode detector can be almost entirely removed, while retaining its advantages, by feeding it from a buffer stage of the cathode-follower type. This not only relieves the tuned circuit of the detector damping, but enables regeneration to be readily obtained

Concluded from page 134 of last week's issue.

FROM what has been said in the earlier part of this article, it will be apparent that the best detector depends largely upon the rest of the receiver. If expense and complication are no drawbacks, then it is always possible to find a solution which fits the requirements reasonably well. Cost is usually important, however, and simplicity is very desirable since it makes for reliability and ease of initial adjustment.

One of the most difficult receivers from the point of view of detector design is the small communication set. Quality is important, as always, but it is not of the first importance. A high input resistance is very desirable, since high IF gain and selectivity are essential; in fact, regeneration at intermediate frequency is often wanted. AVC is essential.

Because of the AVC requirements a diode detector is usually employed, and the DC load resistance is made fairly high to keep the input resistance at a reasonable figure. The detector is consequently not very good from the quality point of view; regeneration is usually obtained from the IF valve. This is not an ideal way, for this valve has tuned grid and anode circuits, and it is the detector circuit to which regeneration would be most usefully applied.

The Cathode-follower

If it were not for AVC, the negative feed-back detector giving regeneration would be much better, or the compromise condition with a small amount of negative feed-back would be very satisfactory, and give at least as good quality as the average diode with considerably higher overall efficiency.

The most obvious solution is to use a negative feed-back detector with a separate AVC system. This cannot well take the form of a diode fed from the tuned input circuit, for this AVC diode will damp the tuned circuit and so do away with much of the advantage of the negative feed-back detector. The right course is to insert a buffer stage between the tuned circuit and the AVC diode.

If one does this, however, one might as well use the diode as a detector as well as an AVC source, for if one uses the

right sort of buffer the disadvantages of the diode disappear. The right buffer is a cathode-follower.

This arrangement is shown in Fig. 5, where V2 is the detector proper. Save for its input circuit it is conventional, and the values of components are chosen as for Fig. 1. Let us make R6 0.75 MΩ and R5 2 MΩ as before. These two in parallel are 0.545 MΩ. With R3 at 10,000Ω the DC load is 10,000 + R4 ohms and the AC load is 10,000 + $\frac{545,000 R4}{545,000 + R4}$ ohms.

To cater for modulation depths up to 95 per cent., a reasonable maximum, the ratio of the loads is $0.95 = \frac{10,000 + \frac{545,000 R4}{545,000 + R4}}{10,000 + R4}$; whence

R4 = 37,000Ω. This is not a standard value, however, so suppose we make R4 = 50,000 ohms; the ratio of the loads is then 0.93, so that the detector will be

the input resistance will be about 30,000 ohms and is low enough to kill any tuned circuit. The cathode-follower, however, has an effective output resistance of only a few hundred ohms, so that even 30,000 ohms is high in comparison.

The valve V1 in Fig. 5 is a cathode-follower. R2 and C2 merely provide decoupling, and R1 and C1 grid bias. The coupling is the coil L1 in the cathode circuit. This coil must be of low DC resistance, so that the voltage drop across it due to the passage of the anode current of V1 through it is very small. The voltage drop should not exceed 1 volt, for it is applied as positive bias to the diode cathode, and if it exceeds about 1 volt it will cause muting and is likely to introduce distortion. With a current of about 10 mA, therefore, the resistance of L1 should be less than 100 ohms.

Input Resistance

The input resistance of V1 depends on the cathode load impedance. When it is inductive the input resistance is positive and it damps the input circuit LC; when it is capacitive and of suitable value the input resistance is negative and there is regeneration. The use of an inductance in the cathode lead is essential in order

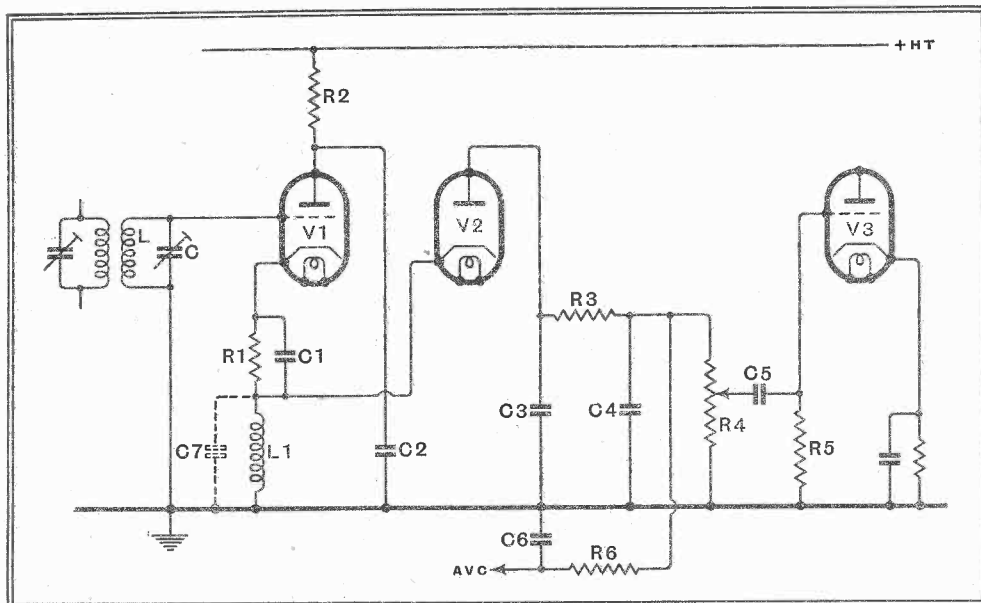

Fig. 5.—This diagram shows the diode detector V2 fed from a cathode-follower V1. By including C7 regeneration can be secured. V3 is an AF stage.

distortionless for modulation depths up to 93 per cent. This is probably good enough for the most exacting requirements.

With a DC load of 60,000 ohms only,

to obtain a path of low DC resistance for the diode circuit, but there is inevitably a capacity C7 in shunt with it. This capacity consists of the self-capacity of L1 plus the heater-cathode and anode-

Modern Detector Circuits—

cathode capacities of V1 plus the anode-cathode capacity of V2 plus any external and deliberately used capacity. Its minimum value is likely to be about 20-25 $\mu\mu\text{F}$. At one frequency it resonates with L1, and the cathode load impedance is then a high resistance. At higher frequencies the circuit is capacitive, and at lower frequencies it is inductive.

If we want a positive input resistance so that regeneration does not occur, then we must make L1 C7 resonate above the intermediate frequency (or at the intermediate frequency), whereas if we want regeneration, L1 C7 must resonate below the intermediate frequency.

The value of the negative input resistance depends on the valve and all circuit quantities associated with it. It decreases with an increase of C7 or the grid-cathode capacity. Incidentally, if C7 is made very large the input resistance will rise again and at length become positive.

The Coupling Circuit

With a given valve it is chiefly the value of the *product* of C7 and the grid-cathode capacity which settles the value of the input resistance. If the former is large, the latter must be small, and vice versa. In one practical case, with a valve having a grid-cathode capacity of 3.4 $\mu\mu\text{F}$, oscillation commenced with C7 at some 160 $\mu\mu\text{F}$. By adding about 10 $\mu\mu\text{F}$ additional capacity between grid and cathode, C7 became only 40 $\mu\mu\text{F}$.

The operation of the valve in the oscillating conditions is considerably affected by the value of the grid-cathode capacity. When this is small it was found with one specimen of the 6F8 valve that the valve ran smoothly into oscillation as C7 was increased. For a further increase in this capacity there was a sudden large increase in the amplitude of oscillation, accompanied by a jump in anode current and a change of input capacity.

With another valve of the same type the effects were rather different. With this specimen there was no sudden change in the oscillating conditions, but the valve ran straight from non-oscillation to oscillation with a bump.

With both specimens it was found that beautifully smooth reaction and freedom from sudden changes in the oscillating condition could be obtained when the grid-cathode capacity was increased to 10 $\mu\mu\text{F}$ or more, and C7 was correspondingly reduced.

With a valve for V1 having an AC resistance of 7,700 Ω , a mutual conductance of 2.6 mA/v, and a grid-cathode capacity of 13.4 $\mu\mu\text{F}$, calculation gives the input resistance as -200,000 Ω when the cathode load consists of a resistance of 30,000 Ω shunted by a capacity of 147.5 $\mu\mu\text{F}$; this is at 465 kc/s. With a tuned circuit LC having a dynamic resistance of 200,000 Ω or more oscillation will occur.

The resistance taken is the input resistance of the diode circuit, the losses in L1C7 being assumed negligible. We

have to proportion L1 and C7 so that at 465 kc/s they behave as a capacity of 147.5 $\mu\mu\text{F}$; actually $C7 = C' + 1/\omega^2 L1$, where C' is the value of capacity given above in farads; C7 is also in farads and L1 in henrys. There is an infinite combination of values of C7 and L1 which will satisfy this equation, so that one value must be fixed on another basis.

There are several ways of doing this. Suppose we arbitrarily make the minimum value of C7 some 50 $\mu\mu\text{F}$, for we shall make this capacity variable as a control of regeneration. Suppose also that at this capacity we make L1C7 resonate at 465 kc/s, so that the input resistance is positive. Then $L1 = 1/\omega^2 C7 =$

nearly always be adequate. If the IF transformer is unusually good C7 can be smaller still, and the writer has had good results with a capacity of 60 $\mu\mu\text{F}$ maximum for C7. This is convenient, since it can then be an air-dielectric component, while retaining cheapness and compactness.

Before discussing this circuit further, it may be as well to point out that the arrangement is much more economical than it looks. The circuit of Fig. 5 can be simplified, but even in this form the apparatus additional to that for Fig. 1 is one triode and valve-holder for V1, two resistances (R1, R2), two condensers (C1, C2), one coil L1, and one variable con-

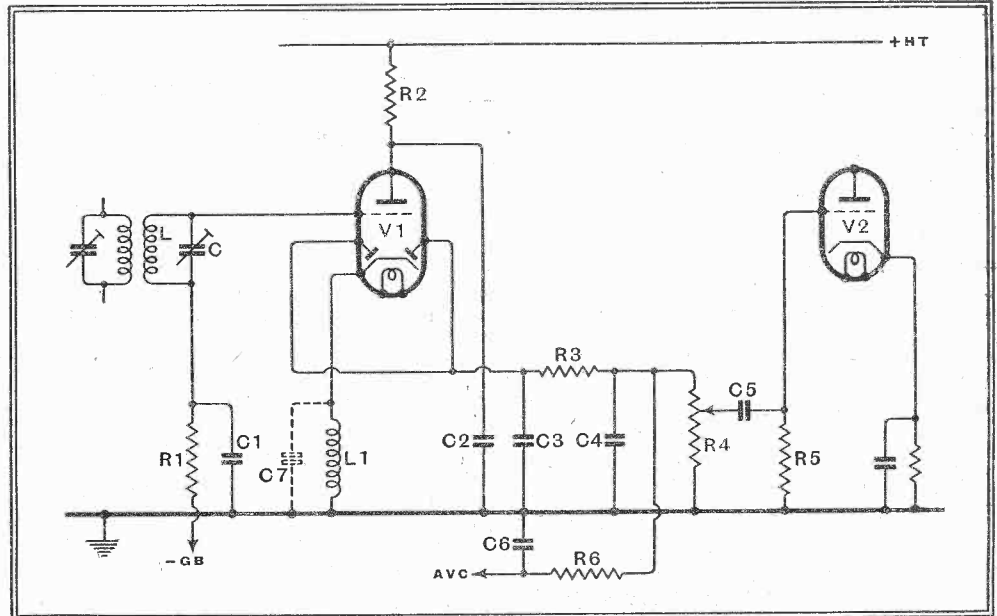

Fig. 6.—The detector and cathode follower can be combined by using a diode-triode as shown here.

$2.36 \times 10^{-8} \text{ H} = 2,360 \mu\text{H}$. Taking this value of inductance, C7 must be $1.475 \times 10^{-10} + 0.5 \times 10^{-10} = 1.975 \times 10^{-10} \text{ F} = 197.5 \mu\mu\text{F}$, say 200 $\mu\mu\text{F}$.

To a first approximation, therefore, L1 can be an ordinary long-wave coil of about 2,200 μH , with a variable condenser of 50-200 $\mu\mu\text{F}$ for C7 as a control of regeneration. Regeneration will increase as C7 is increased. As the grid-cathode capacity of V1 is of the order of 3-6 $\mu\mu\text{F}$ in typical valves, an additional capacity of some 7-10 $\mu\mu\text{F}$ must be connected externally between grid and cathode. With some valves, of course, this may be unnecessary.

The values for C7 given above are, of course, total capacity, and include the circuit stray capacities. These are the anode-capacity of V1, say 5 $\mu\mu\text{F}$, the heater-cathode capacity of V1, say 2 $\mu\mu\text{F}$, the anode-cathode capacity of V2, say 5 $\mu\mu\text{F}$, the self-capacity of L1, some 5-15 $\mu\mu\text{F}$, and wiring capacities, perhaps 5 $\mu\mu\text{F}$; total, 22-32 $\mu\mu\text{F}$. An average value would be around 25 $\mu\mu\text{F}$, so that the actual capacity of the condenser C7 as a component would be about 25-175 $\mu\mu\text{F}$.

If L1 is made larger, C7 can be reduced still more, and in practice a condenser with a maximum capacity of 150 $\mu\mu\text{F}$ will

denser C7 (if regeneration is wanted). For this extra apparatus one gets much higher selectivity from LC, a considerable increase in gain, and better quality.

It is possible to simplify the circuit somewhat by using a diode-triode for the detector and cathode-follower, as shown in Fig. 6. A comparison of the circuit with that of Fig. 5 shows that the only alteration lies in the biasing of the cathode-follower. Cathode bias can no longer be used, because it would bias the diode as well as the triode. R1 and C1 are thus decoupling components, and the grid is taken to a point negative with respect to earth by the bias voltage required. This may be about 9 volts.

The AF Amplifier

An alternative arrangement is shown in Fig. 7. Here a triode is used for the cathode-follower V1 and a diode-triode for the detector and AF stage V2. This removes all biasing difficulties from V1 but transfers them to V2. A different solution is possible here, however, for it is possible to omit any initial bias on the amplifier. Provided that the resistance in the anode circuit is sufficient to limit the no-signal anode current to a safe value, this course is reasonably satisfactory.

Modern Detector Circuits—

The detector output consists of the AF signal superimposed upon a steady negative voltage. This steady voltage is usually removed by the coupling components, and only the AF voltage is applied to the AF stage. It is not essential for this to be done, however, and the steady voltage can be applied as bias to the detector.

In the ideal case the detector output will consist of a steady voltage of $-E$ volts, and with 100 per cent. modulation it will vary over the range $-E \pm E = -2E - 0$ volts. Actually the variation will be somewhat less. The fact that the grid potential of the AF valve will tend to swing to zero grid volts will be likely to cause distortion because grid current is likely to flow up to -1 volt. Ideally, therefore, a fixed minimum bias of 1 volt should be used on the triode.

Parallel-fed Diode

Now we have seen that we can allow up to 1 volt negative bias on the diode anode without seriously upsetting its operation. It is therefore permissible to insert a bias resistance R_5 , shunted by C_5 , in the cathode lead of V_2 . The value of R_5 must be chosen to develop not more than 1 volt.

With a signal the anode current of V_2 falls, and it also changes with the setting of R_4 . With a very strong signal it will be driven to anode current cut-off, but this is unimportant, because the AF signal is then in any case too great for V_2 to handle.

It will be noted that a parallel connected detector is used here. This cannot be avoided because of the common cathodes for the diode and triode sections of V_2 . Unfortunately, it makes more

different kinds of triode are likely to be needed for V_1 and V_3 . Which valve the diode is combined with is largely a matter of convenience, but it is shown in Fig. 8 combined with the cathode-follower. A suitable valve is the 6F8G, and on comparing Figs. 5 and 8, the latter will be quite clear. Suitable suggested values of components are

No such valve is available at present,

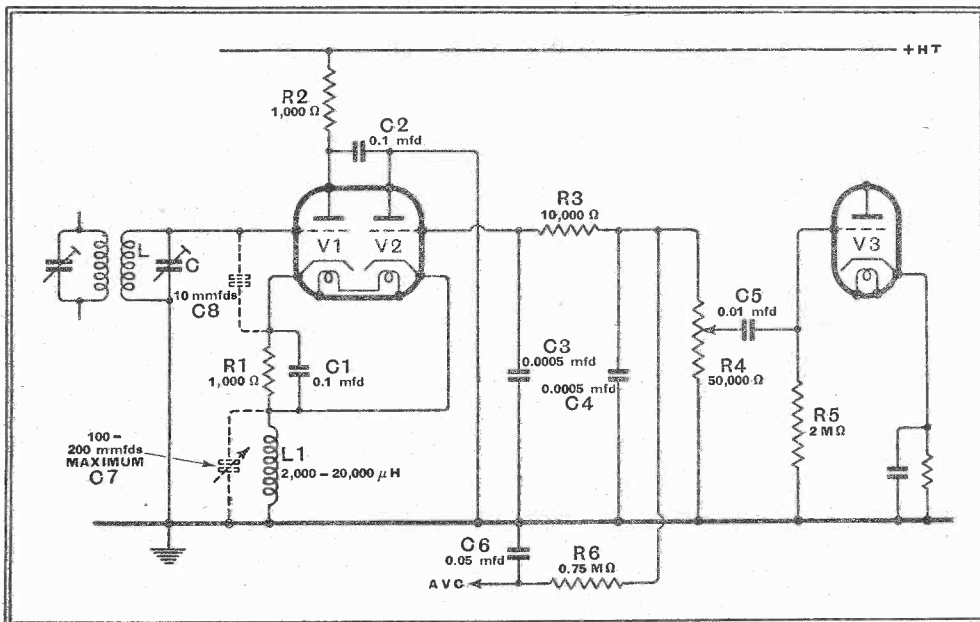

Fig. 8.—If separate valves are not used for each stage, the best arrangement is to employ a duo-triode as shown here. One triode section is used as a diode; the advantage over the diode-triode is that the cathodes are separate.

but among American types there are duo-triodes with separate cathodes, and it is always possible to use a triode as a diode. With such a valve the circuit of Fig. 5 can be followed exactly, one section of the duo-triode being used for V_1 or V_3 and the other for V_2 . The alternative—to use the duo-triode for V_1 and V_3 and

shown on the diagram, and V_1 will consume about 9-10 mA with an HT supply of 250-270 volts. If regeneration is not wanted, C_7 and C_8 should be omitted and L_1 should be about 1,000 μ H. For regeneration C_8 may be needed, L_1 can be 2,000-20,000 μ H (it is not critical), and C_7 should have a maximum capacity of some 100-200 μ F. C_7 can be smaller than this if the IF transformer is a good one. With this valve the grid-cathode capacity is only about 3 μ F. Oscillation can be obtained even with this provided that C_7 is suitably increased, but experience shows that reaction is not as smooth as when the grid-cathode capacity is increased somewhat artificially.

Regeneration Control

In conclusion, it should be pointed out that the use of the cathode-follower form of the Colpitt's oscillator as a means of obtaining regeneration is not confined to the IF circuits. If it is used at really high frequencies, however, the cathode-earth capacity should not be used as a control of regeneration, for it will then cause a large change in the tuning of the input circuit. At high frequencies, regeneration should be controlled by a variable resistance shunting the cathode choke or by varying the voltages applied to the valve. These methods of control are unsuitable at the comparatively low frequency of 465 kc/s, however, and here they have a greater effect on the tuning of the input circuit than varying the cathode-earth capacity.

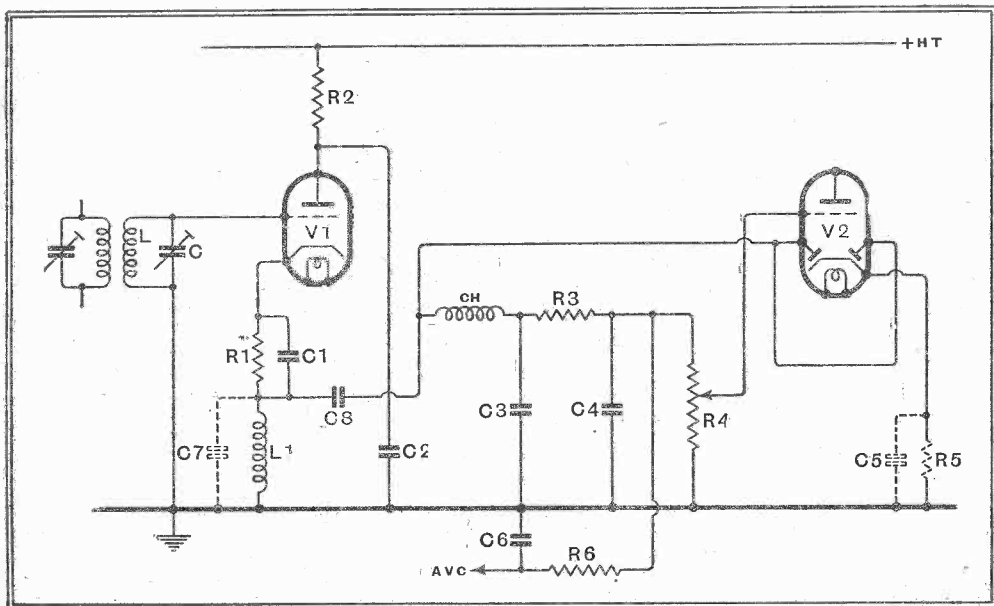

Fig. 7.—As an alternative to the arrangement of Fig. 6 the detector and AF stage can be combined by employing a diode-triode.

extensive filtering of the detector output necessary; hence the inclusion of the RF choke Ch.

a separate diode for V_2 —is not to be recommended, since it brings the AF and IF sections too near together. Moreover,

Twist or Press?

FOR AND AGAINST PUSH-BUTTON TUNING

By "CATHODE RAY"

ALREADY, before Radiolympia has opened its doors, it is clear that there is no slackening in the pre-dominance of push-button tuning. The manufacturers, almost without exception, are increasing the proportion of push-button models in their new lists. (Incidentally, all the recognised systems are still well represented, but it is safe to say that permeability and semi-permeability have gained at the expense of capacity trimmers.) Will sets without push-button tuning become completely obsolete?

Personally, I am very favourably disposed towards push buttons. I, and all the people I know, are more interested in getting a few stations (practically speaking, Reg. and Nat.) well than a great many stations more or less badly. Moreover, I, at least, am lazy. And if neither Reg. nor Nat. (nor A.P.) are turning out anything worth listening to (or seeing) well, we heave a sigh of relief at the thought of having a little time to get on with something else. After all, one doesn't want to be tied to the apron-strings of the B.B.C., or even the A.V.R.O., E.I.A.R., or N.B.C. There are books worth reading, and the car needs occasional attention, to say nothing of the garden, and a spot of photography.

On the other hand, all the people the radio manufacturers know, or ever have known, are quite different. They never listen to B.B.C. stations; and only buy sets at all in order to listen to many foreign stations, for which great range and selectivity (naturally at some sacrifice of quality) are demanded. It is Axiom No. 1 of Radio Manufacturing that a short-range, good-reproduction set cannot be sold. You see I (and all the people I actually know) are quite different from all the rest of the world.

But now comes push-button tuning, giving a limited number of stations. You say, Yes, but all except a very few models have manual tuning as well, so nothing is lost and the push-buttons are just extras for the benefit of odd persons. Well, in that case it is kind of the manufacturers to offer such a large range of models for the benefit of our little minority, if such it be. And as regards nothing being lost, is that quite correct? If the buttoning is one of the pre-tuned circuit systems, there is bound to be extra stray capacity in wiring and switches. That is bound to restrict wavebands slightly. Of course, if an extra waveband is added, that drawback is more than compensated. But design is decidedly

cramped. A RF stage is practically out of the question. The design of the aerial coupling and tuning is also dictated to some extent. The selectivity must be limited (thank goodness!) or it will show up the slightest drift in tuning. If mechanical or motor tuning is adopted, these restrictions do not all apply; but there is the question—apparently not yet finally settled—of whether to put in a couple of extra valves and some awkward little complications in order to provide Automatic Frequency Correction, or to spend just about as much in phenomenal precision of manufacture in order to render AFC unnecessary. Extreme selectivity and sensitivity are not entirely compatible with any system of push-button tuning, though designers have certainly done wonders. Then, too, if push-buttons are to be included, and the thing is to be done properly (save us from the cheap and nasty variety!), there is the temptation to cut costs elsewhere to avoid having to raise the list price. All in all, then, and excluding the higher-priced jobs in which the designer has been allowed a reasonably free hand, it is not quite certain that the push-buttons have been added without any loss on the manual side. So if one's finances don't run to the higher price levels, and one is a typical listener (from the radio manufacturers' point of view), a non-push-button model seems to be a good tip.

As for our little group, we choose push-buttons because selectivity is almost bound to be only moderate (and hence reproduction at least has a chance of being not too

bad), and Reg. and Nat. can be sampled with the minimum of effort.

The fact is, however, as has already been seen, that the tide of push buttons is flooding in. Interesting question for debate: Is this phenomenon to be accounted for by the manufacturers having been wrong in their Axiom No. 1, so that manual tuning is retained merely to preserve some semblance of the old fiction and not really meant for serious use (in due course it will become a sort of rudimentary organ, like an appendix, represented perhaps by a knob-like excrescence on the cabinet); or is the selling value of something new so powerful as to over-ride the fact that only a few peculiar people like myself (and all those I know) are really interested in comparatively local reception?

If the latter, one would expect the development to fizzle out sooner or later (unless it converts everybody). If the former, then there is a hope that the variable condenser may be thrown out of a growing number of the cheaper models, and its value preferably devoted to improving the quality of what is left rather than in reducing the price. So we may at last have a moderate-priced set with its quality of reproduction and convenience of use unhandicapped by the necessity for including long range and selectivity that are never used after the first week. And the people who *are* interested in DX work will have a selection of models really designed for it, somewhat of the semi-"communication" type described recently by Mr. Hallows.

Or am I quite wrong, and most people really like the present hybrid arrangement? I leave you to argue it out at the Show.

Test Report

R.G.D. MODEL 166

Table Model AC Superheterodyne (4 Valves plus Rectifier and Tuning Indicator)

THE same chassis is employed in this receiver as in the Model 386 radio-gramophone and Model 196 console, which are among the first of the new R.G.D. models in the 1939/40 programme. For a table model it is unusually impressive, both in size and on account of the volume and quality of reproduction. It is equipped for push-button tuning, but a large dial makes manual operation almost as easy.

Circuit.—Simplicity is the keynote of the circuit. This is one of those sets which owes its success to a careful balance of performance in each stage, and skill in the distribution of components in the chassis, qualities which do not reveal themselves as "frills" in the diagram.

The circuit shows one interesting feature which might otherwise be overlooked, namely that the pre-tuned circuits, both aerial and oscillator, for the push-button controlled stations, are permeability tuned and adjusted in each case by a single set screw. From the users point of view this is a great improvement on other push-button sets in which the trimmers for aerial and oscillator circuits have to be adjusted separately.

Permeability tuning has also been adopted for the intermediate frequency circuits, and the screwed cores are adjustable by means of a special tool.

Suitable precautions have been taken to ensure stability of operation and freedom from parasitic oscillation in the frequency

R.G.D. Model 166—

changer stage. The IF amplifier is straightforward. In the second detector stage only one of the available diodes is employed for both signal and AVC rectification. Full AVC is applied to the frequency changer and a fraction to the IF valve. The bias for the triode AF amplifier section is also taken from the AVC circuit.

The final stage is rated for an undistorted output of 5 watts. Tone correction is applied in the anode circuit, with separate fixed and variable filters. A switch is incorporated for cutting out the internal loud speaker, and substituting an artificial load to protect the valve, in case the external unit is not connected.

An electrostatic screen is fitted between primary and secondary of the mains transformer.

Performance.—From the acoustic point of view, the performance of this set is outstanding. The balance is excellent, and there is far more bass response of good quality than one would have thought possible from a table model. True, the loud speaker is 10 inches in diameter, and the frontal area of the cabinet is above the average, but these factors alone can hardly account for the undoubted superiority of the acoustic performance. It is interesting to note among other things, that the loud speaker is offset to break the

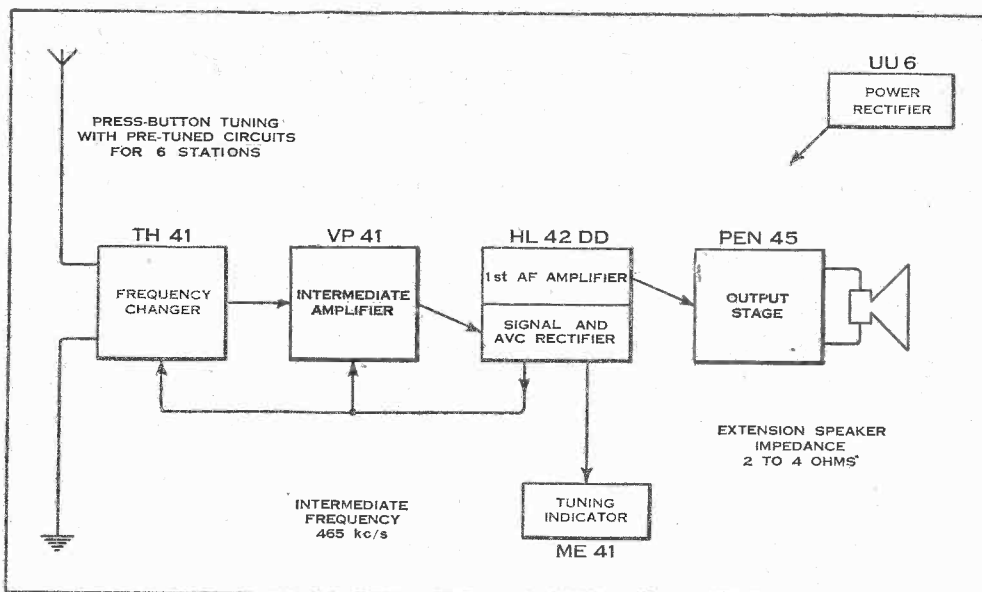

Schematic circuit diagram of the R.G.D. Model 166.

WAVERANGES

Short	16.5-50 metres
Medium	195-550 metres
Long	800-2,000 metres

symmetry of the baffle effect in the cabinet, and that the diaphragm is liberally divided by concentric corrugations. These no doubt contribute to the smooth distribution of response and absence of apparent resonances in the lower register.

Transient response is good, and there is very little intermodulation at audio frequency. As a result, the middle and upper registers are clear right up to the

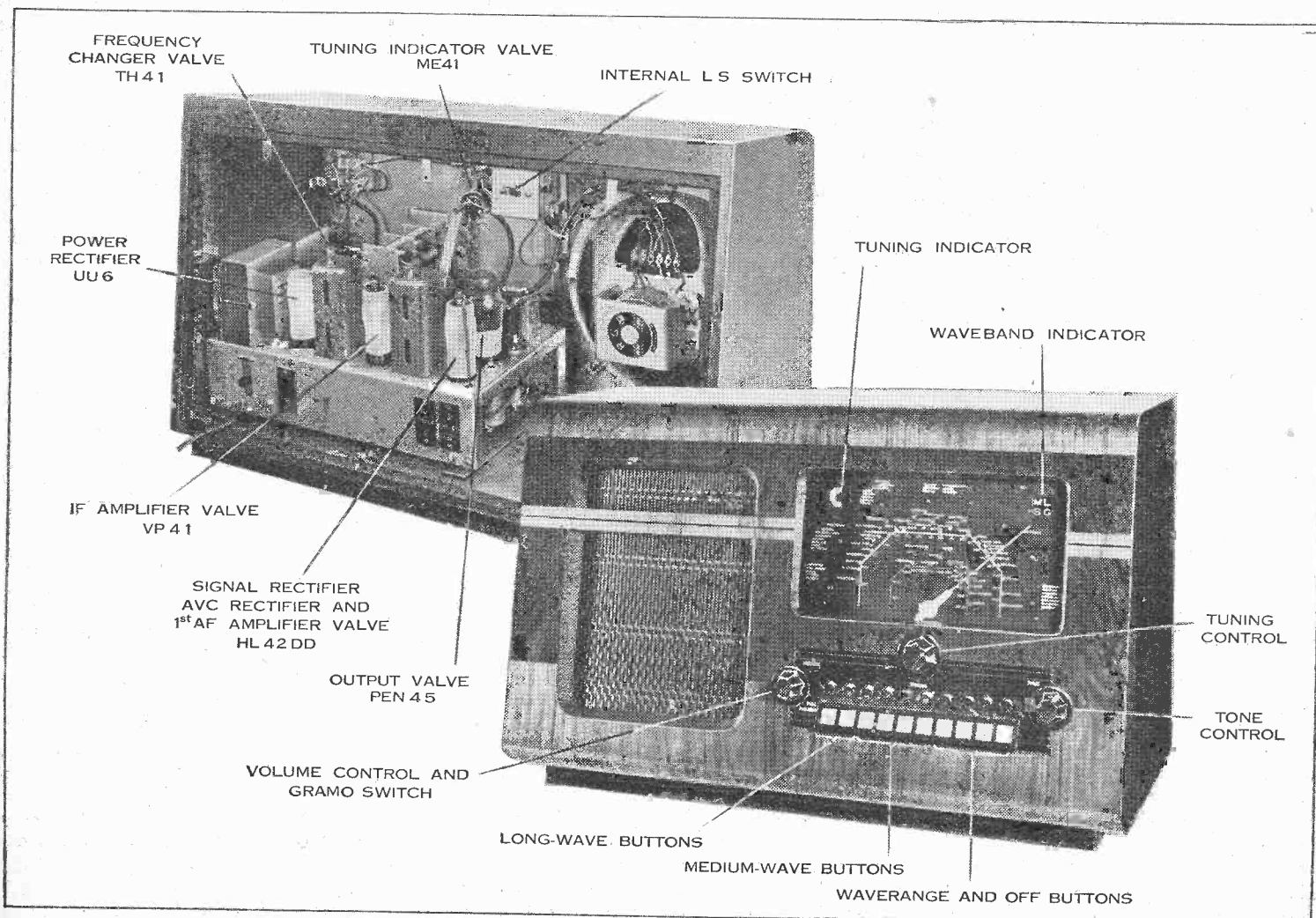

Layout of valves and controls in the R.G.D. Model 166. Trimmers for the station buttons are situated behind the moulded escutcheon. Aerial and oscillator circuits are adjusted simultaneously by a single set screw.

R.G.D. Model 166—

overload point of the output valve. This can be readily overstepped on a strong signal, and the manual volume control must be used to supplement the action of AVC on strong signals.

Reception on the short-wave range is uniformly good at all parts of the scale. At the lower end, a very steady signal was obtained from Bound Brook (W3XL) in the 16-metre band, and full volume was reached at less than a third of the range of the volume control.

There is no fault to find with any aspect of the performance on medium and long waves. No self-generated whistles could be traced in either range, and the amplification was well maintained at each end of the scale. The capabilities of the receiver in bringing in distance stations are fully in keeping with its "big-set" appearance.

Selectivity on long waves gives enough separation between Droitwich and Radio Paris to receive the Deutschlandsender satisfactorily, and on medium waves the spread of the modulation of London Regional, at a distance of 15 miles, does not exceed $1\frac{1}{2}$ channels on either side of its normal tuning point.

Constructional Details.—The cabinet measures 25in. \times 15 $\frac{3}{4}$ in. \times 12in., and is rigidly constructed from the acoustic point of view. There is not the usual crowding of components in the chassis, and the valves, tuning indicator and pilot lamps are all readily accessible.

Controls on the front panel are bold and well placed, but the type of knob adopted for the volume control is not altogether suitable for pulling out, as is required when changing over to gramophone reproduction. This and the difficulty of re-engaging the long holding-down screws which retain the push-button escutcheon plate are the only criticisms we have to offer.

Summary.—The Model 166 is electrically and acoustically a well-finished product, with an all-round performance which will satisfy the requirements of those who require the maximum number of usable programmes with the minimum of fuss. Its quality of reproduction is of a very high order, and challenges comparison with console and radio-gramophone receivers.

Makers' Address.—Radio Gramophone Development Company, Limited, Globe Works, Newtown Row, Birmingham, 6.

to go on with, even if it's no more than a sample of what they've got up their various sleeves.

□ □ □

Wind-produced Current

WRITING from Entebbe, in Uganda, a reader suggests that a promising means of solving the difficulties of those who live in out-of-the-way places far from a charging station may be the wind-driven generator. I believe that there are numbers of these in use in these islands, especially in Ireland. Personally, I have no first-hand experience of them, but no doubt some readers have. Would anyone who has used such a generator be kind enough to let me know whether it proved satisfactory? Its success must depend, of course, largely on the prevalence of suitable winds. There must be many parts of the Empire where there wouldn't be trouble owing to lack of wind; but there must also be many where, as often as not, you get either too much or too little. The wind-driven generator, therefore, couldn't solve the problem everywhere.

□ □ □

Two Lines of Argument

FRANKLY, I found it rather hard to follow the arguments advanced by the B.R.V.M.A. in the recent letter from their secretary (*The Wireless World*, August 3rd) giving the reasons why valve prices are not to be reduced. So far as I could make it out, the reasoning appeared to be this: (1) B.V.A. valves last a long time; (2) very few are sold to the public as replacements in comparison with those sold to the set manufacturers; (3) the man in the street gets a guarantee with his valves and generous service; (4) he spends on the average only a shilling or two a year on valve replacements; therefore present prices impose no hardship; therefore they will not be reduced. That argument could be restated with equal force something like this: (a) B.V.A. valves normally last a long time; (2) but the guarantee and the service cover only three months; (3) the replacement of a single valve may cost a considerable proportion of the value of a not-very-old set; therefore, the prices now ruling do impose a hardship; therefore the average man works his valves until they are on their last legs, unless an accident makes a replacement necessary; therefore he spends only a shilling or two a year on new valves; therefore the volume of business in valve replacements is tiny in comparison with that in sales to set makers; therefore valve prices to the public should be reduced.

Another Point of View

And isn't there more in it than that? By the B.R.V.M.A.'s own admission, "the sales of valves for the maintenance of existing receivers are very small in relation to the sales of valves for new sets." Very well; it surely follows that the profits made by the sales of replacement valves at their present prices amount to a relatively unimportant total in the valve manufacturers' earnings. If that be so, the manufacturers would be taking little risk were they to try the effect of bringing prices down drastically. There can't be the smallest doubt that such action would result in largely increased business. People would replace valves that were badly "down" if the cost of doing so were reasonable. But sales to the set manufacturers would increase too, though there's no need for any reduction in the

Random Radiations

A Television Query

A CORRESPONDENT in the Vale of Aylesbury asks whether I think that he could obtain good results with a television receiver such as that described recently in *The Wireless World*. There is a vision receiver working well at a place about three miles from him, but it appears to be a rather elaborate and expensive model. It's a difficult question to answer. As you may know, the Chiltern Hills come to a somewhat abrupt end at the southern edge of the Vale, which spreads out, flat and rather low lying, from their feet. My correspondent lives close under these hills. His home must be about 250 feet above sea-level, but between him and Alexandra Palace the hills rise to 700 feet or so. As he is also on the fringe of the official service area, I feel a little doubtful of results. At any rate, if I were in his position I'd be inclined to rig up first of all a simple U-S-W receiver with appropriate aerial and to see what kind of reception I obtained of the sound part of the A.P. programmes.

□ □ □

More Kilowatts

IF you have been able to make any use of the short-wave range of your set in the welter of thunderstorms and/or atmospherics which the present parody of a summer has been bringing us for so long now, you have doubtless discovered that, unless a blackout (of the radio, not the A.R.P. variety) was occurring, our old and tried friends W2XAD and W2XAF were coming in with better volume than ever. The reason is that both have gone up from the 20-25 kilowatt rating that has been theirs for so long to 100 kilowatts. I can't remember how long I've made regular use

By "DIALLIST"

of these stations, but it must be over ten years. I know that I used to obtain excellent loud speaker reception, with no noticeable interference, of the 7 p.m. sports commentaries and the 9 p.m. news bulletins with a three-valve "straight" in 1930, though I then lived right on a main road, and used a plain aerial. Such is the volume of motor traffic and of ignition-system interference on that road to-day that people living on it can make little use of the short waves, unless they go in for elaborate anti-interference systems.

□ □ □

The Services at Olympia

WHEN this appears in print there'll be only six days to go before the opening of Radiolympia. I think I'm looking forward to some of the sideshows—particularly those of the Services—as much as anything. So far I haven't heard many details of the form that they're to take, but they are bound to be interesting, for the use of wireless has developed so vastly in all the Defence branches of late. Those who organise these sideshows may be somewhat handicapped by so many new things being necessarily of the hush-hush order; but I'm sure they'll be able to exhibit apparatus and systems that will be of interest to us all. I'm specially hoping that some of the newest systems for guiding both ships and 'planes to port when visibility is of the poorest will be shown. There are many Army gadgets, too, that I'd much like to have a look at. Some of them will undoubtedly be there, though others almost certainly won't. What they do let us see will be wonderful enough

prices to them. Prospective buyers are definitely afraid of buying sets with more than five valves in them because of the possible cost of a mishap, necessitating replacements. That fear would vanish, and, with the coming of bigger sets containing real novelties and real refinements, brisk business in wireless would be a certainty.

~ ~ ~

Sorry to Part

PHEW! I've just finished the job of packing up four wireless sets which I'm returning to those that made them after having had them on loan for trial. Over three of them I have no tears to shed, for they are just the four-valve superhet receivers that have become almost standardised as the medium-priced set of to-day. Good enough value for money, but all much of a muchness. The fourth set, though, I really do regret. It is a first-rate communication receiver, and, I think, the most interesting set that I've ever handled. When you work it you have much the same feeling as you have when driving a high-powered motor car; there's always lots in hand. This set has actually both IF and LF gain controls, but so big is the reserve of amplification that I've never had to use it with either of them anything like full out. And the stability! Once you've noted a station's reading you can get it at any later time at the same setting to a hair's-breadth. You can tune in a station and turn the send-receive switch over to "send"; come back in an hour's time, flick the switch to "receive" and the station's still there. There's not a single ghost of an image on any waveband. And so glorious is the band-spreading that even on the 21-Mc/s band the pointer travels a full tenth of an inch between stations occupying adjacent channels. Yes, I'll sigh for that set!

Beethoven Sets for 1940

FIVE new receivers are announced by Beethoven Electric Equipment, Ltd., Chase Road, North Acton, London, N.W.10. They include two portables and a transportable with press-button tuning.

The PBA40 transportable is a three-valve (plus rectifier) superhet, for medium and long waves, and is priced at £10 17s. 6d. The two portables are the P48 at 10 guineas, including batteries, and the P46 at 10½ guineas, for operation from AC/DC mains, in which the tuning system is mechanically operated.

The other two sets are 5-valve table-model superhets with press-button tuning. They are the Model PAC47 for AC mains, and the Model B43 for battery operation. Prices are not yet fixed.

The firm is also producing an all-dry battery portable weighing 15 lb. This is the Model P44, which costs £6 19s. 6d. complete.

HENRY FARRAD'S SOLUTION

See page 144

BOB is quite right in suspecting that the slightly different rated grid bias is insufficient to account for complete absence of results. The difference is only what is liable to exist between different samples of identical type, and in any case the bias is usually provided by a cathode resistor which automatically compensates for reasonable differences.

But the fact that both the ACVPr and the

OLYMPIA RADIO SHOW
AUGUST 23RD TO SEPT. 2ND.
SPECIAL EXHIBITION NUMBERS

Fully illustrated descriptions of everything of interest at the Show will appear in specially enlarged issues of *The Wireless World* for:

AUGUST 24TH. **SHOW REPORT.** A comprehensive guide to the exhibits of broadcast and television receivers, components and accessories, including a keyed plan of the stands.

AUGUST 31ST. **SHOW REVIEW.** A critical analysis of technical features and tendencies as revealed at the Show.

VP4B fit 7-pin bases and a top cap connector must have led him to assume that the connections are the same, whereas by referring to the instructions (or to the *Wireless World* Valve Data Supplement) he

could see that the ACVPr has a "top anode" and the VP4B, being a more recent type, has a "top grid." The interchanging of these two rather vital elements is quite enough to account for failure to work!

Philips 1940 Programme

FOUR TELEVISION SETS AND TEN BROADCAST RECEIVERS

WITH the exception of the large screen projection model all the television and broadcast receivers in the 1940 Philips programme are new. The television receivers are four in number, two for sound and vision only and two which include the latest five-valve all-wave broadcast chassis with push-button tuning. The table model for television only (Type 2405) has a 9in. tube and costs 32 guineas, the Type 2407 at 35 guineas is for those who prefer a console while the Type 2412 at 45 guineas is the console model with a built-in wireless receiver. Type 2415 at 55 guineas goes one

long-wave stations can be varied to suit the requirements of the user. Waveband switching is effected automatically.

Other interesting technical features of the new models include variable negative feedback coupled to the volume control so that maximum range is obtained on weak sta-

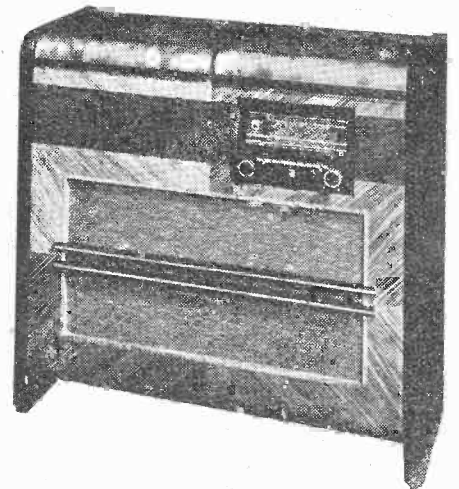
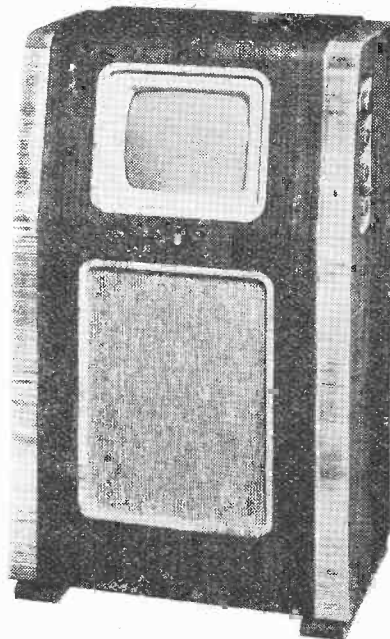

(Above) Model 711A radio-gram. (Left) Console television model 2407. (Below) All-wave superhet, type 735A.

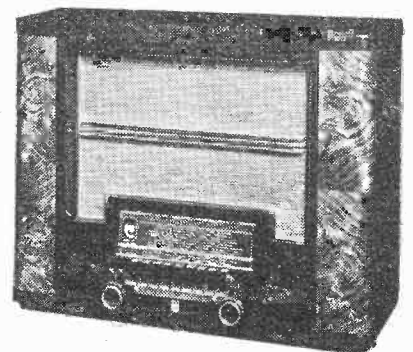

step farther with a larger tube giving a picture size of 10 by 8 inches.

Including the latest car radio and battery portables there are ten broadcast receivers in the new range. Four of these, including the very attractive model 711 radio-gram, are fitted with an ingenious mechanical press-button tuning system in which the proportion of buttons allocated to medium and

tions, and the best quality on powerful local transmissions.

Full details of types and prices will be included in next week's Guide to the Show.

Letters to the Editor

The Editor does not necessarily endorse the opinions of his correspondents

Reproduction Levels

AS this discussion has been spread loosely over several months it may be helpful to recapitulate:

(1) *Is it necessary, in order to avoid distortion, for sound to be reproduced at the same intensity as in the original performance, intensity being measured at the listening ear in each case?* All three parties (Mr. Hughes, Messrs. Pacent and Likel, and myself) appear to be in agreement that it is.

(2) *Is it practicable to do so in domestic circumstances?* Messrs. Pacent and Likel apparently answer with a downright No; Mr. Hughes says Yes and No according to circumstances; and judging from his latest letter seems to interpret mine as a definite Yes. Actually, my point was to show that full scale is not so impracticable as is often implied; but I admitted that there were difficulties in some circumstances and suggested high-quality phones as a solution.

(3) *In circumstances where full-scale reproduction is impracticable, is it possible to restore the original "tonal balance" by means of tone compensation?* Messrs. Pacent and Likel's original article was presumably based on the assumption (which is generally held) that it is. Mr. Hughes, in his letter published last week, claims to be original in saying that it is not. I confess that this aspect of his argument had rather escaped me; but, if I may say so, the definiteness of Mr. Hughes's statement that "in no natural way is it possible to hear music softly and yet preserve the same 'tonal balance' as exists when it is heard loudly," seemed to be slightly obscured by his saying in the same letter that "it is true, of course, that if we listen at a level lower than the original, then tone compensation is essential to preserve the original 'tonal balance.'" A definition of "tonal balance" seems to be needed at this stage. It has already been agreed that something of the original is lost when it is reproduced on a reduced scale, by virtue of that fact and quite apart from any upsetting of frequency characteristics. The impression of a stormy sea as a background to stormy emotions that Wagner intended to convey by his "Flying Dutchman" Overture cannot possibly be effected at a low sound intensity, no matter how it is faked. If "tonal balance" means the relative audible proportions of every element of sound making up a musical or other performance, then again it is safe to say that simple tone compensation cannot restore it perfectly. For one thing, loud sound introduces subjective harmonics and combination tones due to distortion within the ear. These cannot be restored by tampering with the frequency characteristic of the amplifier. A loud trumpet reproduced softly loses much of its "brassiness," tone compensation or no. Even neglecting this effect, a tone compensation system would have to vary its characteristic continuously during the programme in order to keep the original "tonal balance" correct, and I am not at all sure that it could succeed even then.

Finally, departing from the standpoint of strict theory, and defining "tonal balance" as the general impression the listener gets of the proportions of low, middle, and high

tones, is tone compensation of any avail? I have written before to point out the fallacy in coupling tone compensation mechanically with volume control. The two things are not correctly related. But granting that the tone compensation is set to the best adjustment for any given programme, I suppose I would have agreed with the usual belief that the general impression of tonal balance would be more or less put right.

It is at this point, if I understand him correctly, that Mr. Hughes comes in and says that any such messing about with the frequency characteristic may help to restore the theoretical balance, but from an artistic point of view is a waste of time because it gives an unnatural result; if we are forced to hear music softly, let it be like real music heard afar off.

To be quite candid, I really don't quite know where I stand about this. I do know that I have never found tone compensation as satisfactory as theory would predict; and Mr. Hughes's point may be the explanation of this. On the other hand, as a "next best thing" I don't reject a fake on principle, as some might. Perhaps some artistic engineers would contribute to this discussion and help solve the problem.

"CATHODE RAY."

Standard Television

THE most remarkable feature of this year's German Radio Exhibition (which I have just visited) is the extent to which officialdom has dictated to the radio industry on the subject of standardisation. A perusal of any report on the Show will indicate on what a broad basis this urge for standardisation has been effective. Whereas in the past individual manufacturers had been free to produce receivers and components to their own taste and design, now they have to conform to a limited number of standard specifications. The object is, of course, to reduce costs of production and by careful design to lessen the number of parts and the quantity of material used.

Whilst nobody would advocate that the same procedure should be arbitrarily adopted in this country, yet it seems to serve as an object lesson to the extent of reminding our manufacturers that there is still to-day a great deal of unnecessary departure from some sort of standardisation.

The "People's Receiver" in Germany really started the ball rolling in this direction, for manufacturers had to produce this set to a standard design and the component parts were also standardised. The scheme has now spread to television, and a standard set has been designed and is being produced by various factories with the object of having only one television receiver available for purchase by the public at a standard price with a standard performance, and with all parts interchangeable regardless of what factory produced it. Standardisation of television pushed to this point would be a mistake here because it must retard development and discourage competition between different manufacturers, but this does not mean that there is no case for a standard television set to help to get television going properly in this country.

Many months ago *The Wireless World* urged that British producers of television sets ought to co-operate to achieve standardisation as far as possible. Such a scheme would have the effect of reducing prices and facilitating servicing to a very great extent, because those engaged in this work would concentrate on acquiring an expert knowledge of the standard instruments instead of having to become acquainted with a variety of different models.

When those views were expressed it was also said that it would be necessary to see that the standard set was so produced that it would not compete with better models, which would still sell to those who wanted something better either in performance or appearance than the standard.

It seems a pity if, in spite of our long lead in television, standardisation should be the means to enable other countries to increase the number of television sets in use at a greater rate than we are able to do ourselves.

"TELE-VISIONARY."

Weather and Wireless

WE have read with very great interest the article by Mr. D. W. Heightman in your issue of August 3rd, and your editorial comment upon it. We have been engaged for some time on experiments of a similar nature, and it is of interest to compare the results we have been getting with those obtained by Mr. Heightman.

In the first place it should be noted that observations concerning the relation between meteorological conditions and ultra-short-wave propagation conditions have previously been reported, notably by Hull¹ and Scholz and Egersdörfer.² Both these sets of workers have found the intensity of signals of frequency 60 Mc/s, propagated over distances beyond the optical range, to be closely related to the way in which the atmospheric temperature varies with height in the first few kilometres above the ground; and both found that inversion effects produce increased strength of signal.

For the purpose of making a detailed study of these effects we considered that it was necessary to make accurate measurements of the signal strength of a station which we knew to work on the same power regularly every day, and which was situated just beyond the optical distance from the receiver. We therefore chose to measure at Cambridge the sound transmission from the Alexandra Palace television station (distance 70 km., frequency 41.5 Mc/s). The measurement was made by an automatic recording method involving the injection of a measured signal for standardising purposes. This procedure of precise measurement has been fully justified in view of the fact that the day-to-day changes in signal strength have been relatively small. Observations have been made regularly since May 5th, on the morning, afternoon, and evening transmissions.

We have found that the signal sometimes exhibits marked fading, and we have some reason to suppose that two types of fading

¹ *QST*, Vol. 19, p. 13, June 1935.

² *T.F.T.*, Vol. 28, p. 77, March 1939.

are present, one due to an interference mechanism between two or more rays, and the other due to variations in the propagation conditions for a single ray. The most violent fading has been found to occur on the evening transmission.

For each period of transmission we have taken the mean signal strength and plotted a curve to show the variation of this mean from day to day. We have tried to relate the resulting curve to many meteorological phenomena which might be of importance. We do not consider that we yet have enough observations to draw any significant conclusions concerning the relation between signal strength and meteorological conditions, but one or two interesting points emerge from a comparison of our results with those of Mr. Heightman. For example, we do not find the greatest mean signal on the days when he finds the best "extended-ground-wave" conditions, but we notice that on these days the fading was very pronounced (especially in the evenings) and the peak signals were very high. It is possible that, when estimating the goodness of transmission conditions by ear, it is the peak signals that are estimated. A curve showing the mean signal during the afternoon transmission shows marked maxima near May 14 and June 12th. Days near these dates were marked by abnormal temperature distributions in the upper atmosphere rather than by temperature inversions near the ground. The difference between these results and those of Mr. Heightman may be attributable to the difference in the method of measurement, to the difference in wavelength, or to the difference in transmission distance. It is clear that a detailed understanding of the processes involved will necessitate an extended study of the signal strength and the fading at different distances from constant-power senders of different wavelengths. We are very glad to note that Mr. Heightman proposes to start a series of precise measurements on the signal from the television station; we look forward to an interesting comparison between his results and ours.

The close relation between the signal propagation conditions and the meteorology of the upper atmosphere leads us to hope that once the connection is better understood, simple measurements of signal intensity and of fading conditions may replace or supplement the much more laborious direct exploration by means of aeroplanes. If this were possible it might well be that wireless observations would prove of importance in weather forecasting.

J. A. RATCLIFFE.
A. H. WAYNICK.

Cavendish Laboratory, Cambridge.

Separate Speakers

I WAS surprised to read in *The Wireless World* of July 27th an admission by "Diallist" that he does not know of any set apart from communication receivers which is not fitted with a built-in speaker. My knowledge of sets on the market to-day is far from being comprehensive, but I can immediately think of three manufacturers who supply sets with separate speakers namely: The Lowther Manufacturing Company, Dynatron Radio and E.M.G. Hand-Made Gramophones (Davey Radio).

To the seeker after realistic reproduction the separate speaker offers many advantages in addition to those mentioned by "Diallist." It can be placed in the best acoustic position in a room and completely controlled from a distance at which it can be properly

heard. Being independent of the design of the set cabinet more efficient loading of the diaphragm can be obtained by the use of a horn or special baffle board.

I have used separate speakers for the past 18 years and the quality of reproduction from them has never failed to excite favourable comment from listeners accustomed to using a set with built-in speaker. I conclude, therefore, that there is a demand for a good-quality outfit with separate speaker and am surprised that so few manufacturers attempt to supply it.

D. DIXON.

Reading.

Valve Prices

THE B.R.V.M.A.'s statement, published in your issue of August 3rd, that no reduction in valve prices is contemplated is hardly a bombshell. In fact, we half suspected as much. Well, the Association ought to know, so we must resign ourselves to the inevitable.

The admission that the sale of valves for replacement purposes is a very small proportion of total sales seems to suggest that the B.R.V.M.A. members could reduce the prices of their valves to the public for replacement purposes to something more nearly approaching the price the same public pays for the same valves as part of the price of a new set, and with little loss to themselves even if the sale of valves was not thereby increased.

We know also, though the B.R.V.M.A. does not mention it, that there is a considerable potential market for valves at a lower price. My own experience suggests that probably five out of six valves now in use are sufficiently below par to affect the per-

is still working after a fashion. Without doubt a reduction in price, along with a campaign by advertisement and personal contacts with servicemen, would result in a greatly increased turnover and, dare I suggest, greater profit to the manufacturers.

The B.R.V.M.A.'s calculation of the cost of valve maintenance supports my contention. A replacement of a quarter of a valve per annum (I suppose that is roughly what "a few shillings" represent) in a five-valve set, means complete replacement in 20 years. That estimate verges, shall we say, on the optimistic, even with our modern valves, and suggests that the public lack the incentive to keep their receivers in proper trim, presumably owing to the high cost involved.

Might I suggest that every set ought to have at least one complete change of valves in the course of its career and, that being so, the replacement sale should at least equal the sale for new receivers? Might I suggest, also, that the B.R.V.M.A.'s optimism is based on the misconception that all replacement valves are sold by members of the Association, whereas a considerable number are actually being obtained from cheaper sources?

R. HINDLE.

Elland, Yorks.

High-power Air-cooled Valves

ACCELERATING HEAT DISSIPATION

THE introduction by Philips in Holland of a new type of air-cooled transmitting valve facilitates the installation of relatively high-power stations on board ship or in other circumstances where water cooling cannot be conveniently arranged. The transmitter shown here is rated to deliver 6 kW to the aerial; the bank of carbon lamps on the left act as an artificial load. In the inset photograph are shown details of the metal radiator fitted to the valves. A stream of cooling air from a blower is directed through jackets over the radiators.

The air-jacketed valves in use; inset is a metal radiator which is fitted over the envelope.

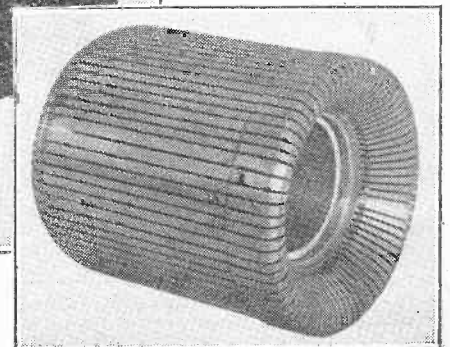
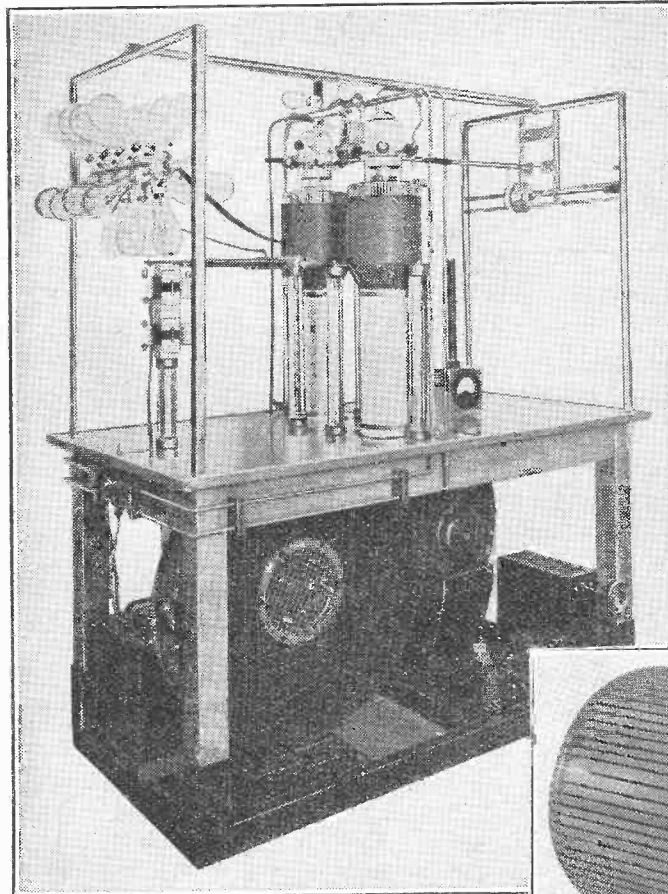

formance of the set, but it is with difficulty that anyone can be persuaded to pay the present price to replace a valve which

Recent Inventions

SHIPS' DF SETS

QUITE apart from the so-called "quadrantal" error, which can be corrected in various ways, it is found that signals coming in athwart a ship give a less satisfactory DF indication than those which arrive along the fore-and-aft line of the ship.

The invention provides means to overcome this difficulty, so that an equally clear-cut bearing-line can be obtained no matter from what direction the beacon signals arrive. The desired effect is secured by combining an auxiliary voltage, derived from a non-directional aerial, with the signal voltage picked up from a rotating frame aerial. The auxiliary voltage is made up of two parts, one being of constant value, whilst the other is variably coupled so that it alters in value with the changing signal-strength picked up by the rotating frame aerial. The combination allows the necessary correction to be made to ensure an equally clear-cut DF response to all signals.

Telefunken Ges. für drahtlose Telegraphie m.b.h. Convention date (Germany) November 16th, 1937. No. 505547.

SAFETY DEVICES FOR CR TUBES

UNLESS the scanning-spot is kept in constant motion, it is liable to damage or burn the screen of a cathode-ray television receiver, particularly when high accelerating voltages are used, as in the so-called "projection" type of tube. The same danger also exists in the case of the mosaic-cell type of screen used for transmission.

The invention provides means for rendering the scanning spot

Brief descriptions of the more interesting radio devices and improvements issued as patents will be included in this section.

harmless in the event of any failure or breakdown in the normal supply of scanning voltages to the deflecting plates of the tube. The Figure shows a method of safeguarding the mosaic screen of a transmitting tube.

Current at line frequency is supplied to the magnetic scanning coil L from a time-base generator A, and at frame frequency to the coil F from a generator B. Both generators are coupled to rectifiers R1, R2 which are arranged in series in the grid circuit of a control valve V. Should either of the scanning generators A, B fail, the resulting drop in grid voltage reduces the anode current of the valve V and opens first a relay contact K, and then a more powerful relay K1. The latter disconnects the high-tension supply from the transmitter tube, and so renders the scanning beam harmless.

E. L. C. White and C. L. Faudell. Application date, October 11th, 1937, and January 21st, 1938. No. 505490.

MOTOR CAR SUPPRESSORS

THE Figure shows a method of eliminating interference from the ignition system of a motor car. The points of each sparking-plug are fed from the secondary coil S of the ignition supply through leads containing suppressor resistances R, R1. The primary leads also include chokes K, K1, and shunt condensers C, C1, which are earthed at E to the chassis of the car.

A screen M is connected to one side of the secondary winding, and isolates the whole of the high-tension side of the ignition from the chassis and engine. The primary side is not screened between M and the make-and-break contact P. Decoupling is assisted by completely insulating the transformer windings; and by

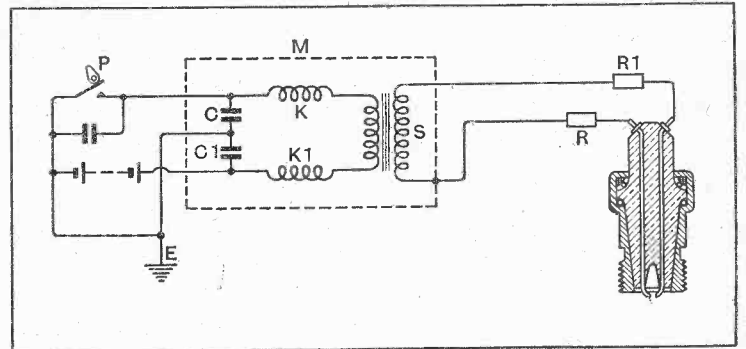

Interference suppression system for internal combustion engine.

isolating the two coils statically from each other by open screens, which do not noticeably reduce the inductive coupling required to step-up the "sparking" voltage.

Siemens Apparate und Maschinen Ges. Convention date (Germany) November 14th, 1936. No. 505622.

"POLARISED" WAVES

TWO sets of signals can be transmitted simultaneously on the same wavelength, if one

carrier wave is polarised horizontally and the other vertically, preferably by being radiated from dipoles set at right-angles to each other. A similar aerial arrangement at the receiving end allows each signal to be received separately from the other.

The method is useful for relaying two different television programmes from point to point without mutual interference, in circumstances when separate wavelengths may not be available. It can also be used for reproducing television programmes in colour, the two sets of signals being passed through

different colour-filter assemblies. Similarly a stereoscopic effect can be obtained with the aid of the two separate channels so provided, or a stereophonic or binaural effect in the case of a sound programme.

A. D. Blumlein. Application date October 4th, 1937. No. 505079.

SCANNING IMPROVEMENT

THE eye is very sensitive to any error in the correct "sandwiching" of the two sets of lines used in interlaced scanning, a displacement even of one per cent. being noticeable. The main cause of this kind of error is the incomplete separation of the frame and line impulses, and the object of the invention is to make the separation easier by suppressing the line impulses for a short period, before and after each framing impulse.

In practice, this is effected by inserting between the line impulse generator and the mixing valve at the transmitting end, a valve which is periodically made non-conductive by a voltage derived from the frame impulse generator, so as to prevent the line impulses from passing through for a period rather greater than the duration of each framing impulse.

Radio-Akt. D. S. Loewe. Convention date (Germany) October 26th, 1936. No. 504460.

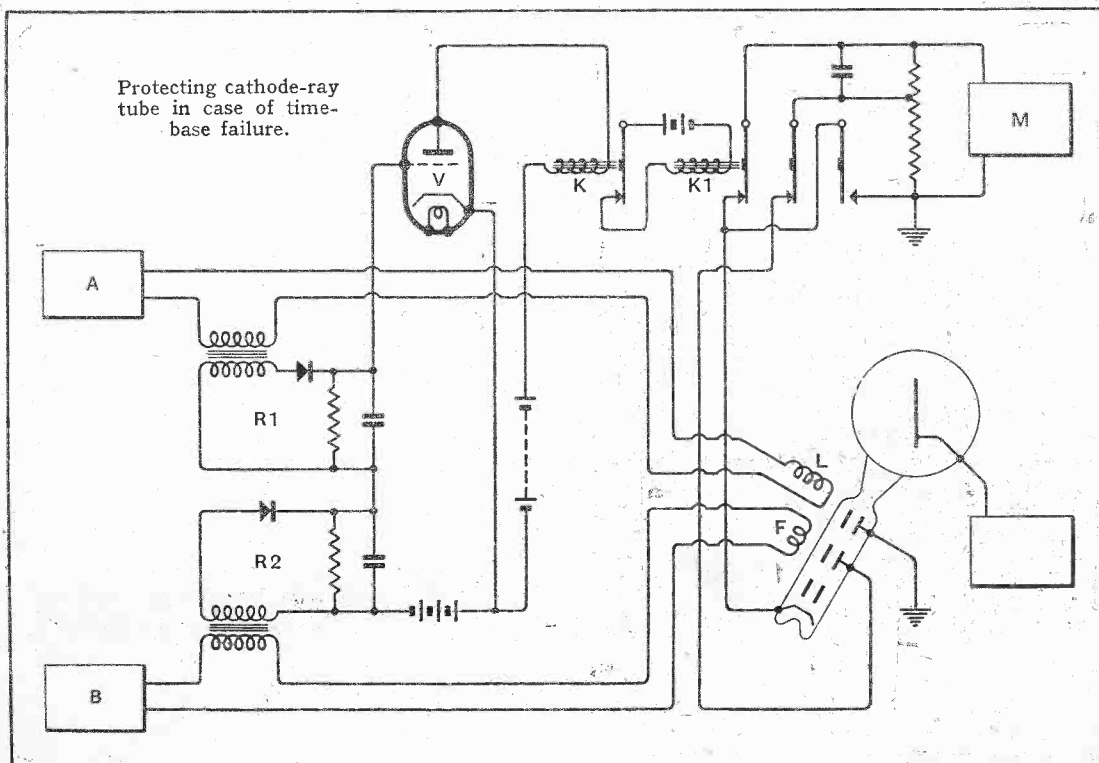

The British abstracts published here are prepared with the permission of the Controller of H.M. Stationery Office, from specifications obtainable at the Patent Office, 25, Southampton Buildings, London, W.C.2, price 1/- each.

A NEW CONCEPTION OF HIGH FIDELITY REPRODUCTION

GOODMANS *Infinite Baffle* LOUDSPEAKER



This instrument represents the most advanced technique in High Fidelity reproduction, and is the outcome of extensive development by GOODMANS Research Laboratories. As there is practically no mechanical restriction of the diaphragm movement, the fundamental resonance of the unit has been reduced to below audibility. The complete instrument possesses these outstanding advantages—

**Really true reproduction down to 40 c.p.s.
Complete freedom from frequency doubling.
Exceptionally good transient and high note response.
Entire freedom from "colouration".**

Although designed for use with High Fidelity equipment, the reproduction from any good class radio receiver will be materially improved by the use of the "Infinite Baffle".

**Brief Specification:—Power Rating Capacity: 15 watts
A.C. Peak. Speech coil impedance: 2.5 ohms. Weight: 42 lbs. £10**
(Excluding Transformer)

(Supplied fitted in plain loudspeaker case, 18" x 18" x 18", finished grey. High grade cabinets also available in various finishes).

GOODMANS INDUSTRIES, LTD.,
Lancelot Road, Wembley, Middx. Phone: WEMbley 4001 (5 lines)

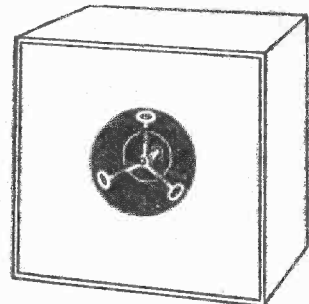
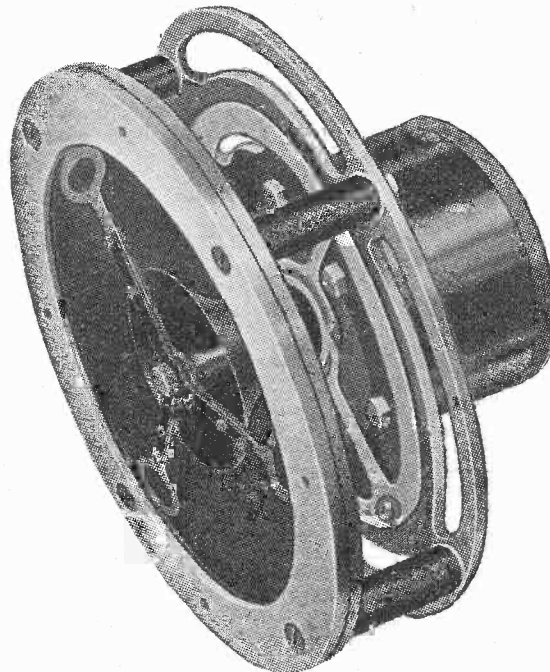

FREE TECHNICAL BOOKLET

To :
GOODMANS INDUSTRIES, LTD.,
Lancelot Rd., Wembley, Middlesx
Please send me full details of the new "Infinite Baffle" Loudspeaker, together with a copy of your 20-page Technical Booklet, "The Attainment of an Ideal." I enclose 1/6 stamp towards postage.

Name

Address

W.W. 17/8/39

Attach this to your card or letterheading.

POST THIS COUPON ▶

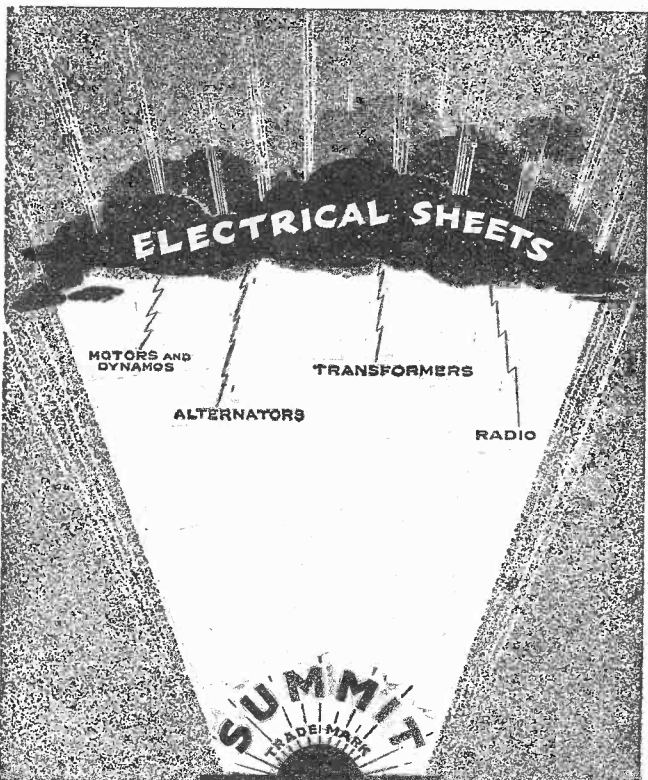

ADDRESS ALL ENQUIRIES TO
JOHN SUMMERS & SONS LTD.
SHOTTON : CHESTER

Established 1851

Telephone :
CONNAH'S QUAY 200

Telegrams :
SUMMERS CHESTER

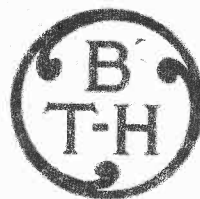

SOUND AMPLIFYING EQUIPMENT

Designed to meet your special requirements.

Incorporating:—

- **VOLUME CONTRACTION—**
giving automatic control when used with microphones.
- **VOLUME EXPANSION—**
automatically restoring tone contrast when used with gramophone records.

For installations in:—

Town Halls, Law Courts, Swimming Baths, Aerodromes and any other location, indoor or outdoor, where sound amplification is desirable.

Send your enquiries to:
SOUND REPRODUCER SALES.

BTH RUGBY

THE BRITISH THOMSON-HOUSTON COMPANY LIMITED, RUGBY, ENGLAND



A2698N

The
Wireless
World

CLASSIFIED ADVERTISEMENTS

NOTICES

THE CHARGE FOR ADVERTISEMENTS in these columns is

12 words or less, 3/- and 3d. for every additional word.

Each paragraph is charged separately and name and address must be counted.

SERIES DISCOUNTS are allowed to Trade Advertisers as follows on orders for consecutive insertions, provided a contract is placed in advance, and in the absence of fresh instructions the entire "copy" is repeated from the previous issue: 13 consecutive insertions 5%, 26 consecutive, 10%; 52 consecutive, 15%.

ADVERTISEMENTS for these columns are accepted up to **FIRST POST** on **MONDAY MORNING** (previous to date of issue) at the Head Offices of "The Wireless World," Dorset House, Stamford Street, London, S.E.1, or on **SATURDAY MORNING** at the Branch Offices, 8-10, Corporation Street, Coventry; Guildhall Buildings, Navigation Street, Birmingham, 2; 260, Deansgate, Manchester, 3; 26a, Renfield Street, Glasgow, C.2.

Advertisements that arrive too late for a particular issue will automatically be inserted in the following issue unless accompanied by instructions to the contrary. All advertisements in this section must be strictly prepaid.

The proprietors retain the right to refuse or withdraw advertisements at their discretion.

Postal Orders and Cheques sent in payment for advertisements should be made **& Co.** payable to **ILIFFE & SONS Ltd.**, and crossed. Notes being untraceable if lost in transit should not be sent as remittances.

All letters relating to advertisements should quote the number which is printed at the end of each advertisement and the date of the issue in which it appeared.

The proprietors are not responsible for clerical or printers' errors, although every care is taken to avoid mistakes.

ARMSTRONG

QUALITY YEAR

The age of "gadgets" has passed. To-day the marvel of radio has become commonplace through use and familiarity. In our opinion there is a vital reason for purchasing a new set—Quality! Since last season we have worked exclusively to this end and believe with these new chassis we have achieved our objective—

—OUR NEW 1940 CHASSIS—

include the following:

SUPERHET - STRAIGHT 10 - VALVE ALL-WAVE HIGH FIDELITY RADIOGRAM, MODEL SS10

incorporating Two Independent Circuits, Superheterodyne and Straight, having R.F. Pre-amplifier and R.C. Coupled Push-Pull Triode Output capable of handling 8 watts.

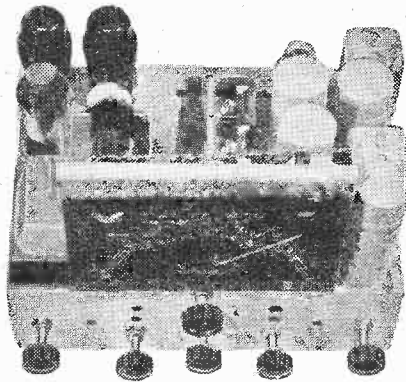

The circuit of the SS10 is unique. When used as a STRAIGHT receiver two HF stages are in operation with A.V.C. Diode Detector is used for distortionless detection together with Triode Push-Pull output. A turn of only one knob is necessary to switch from "Superhet" to "Straight." The Gramophone Amplifier has been specially studied and records can be reproduced with excellent 12 gns.

SEE AND HEAR THEM ON
STAND 69
RADIOLYMPIA

MODEL SS2B—10-V SUPERHET-STRAIGHT 2-WAVEBAND HIGH FIDELITY RADIOGRAM

This model has all the outstanding features of the SS10 the circuit being identical in every respect, except that the chassis is designed for Broadcast bands only, no provision being made for Short Waves. It has the same extremely lively performance on "Superhet" and high quality reproduction on "Straight" 11 gns.

MODEL AW38—8-V ALL-WAVE SUPERHET

This radiogram chassis has R.C. Coupled Push-Pull Output capable of handling 6 watts.

This being our Quality Year we have carefully studied the design of our more economically priced models and it's now possible for those requiring 8 gns. quality with economy to satisfy their desire.

MODEL AW125PP—12-V 5-BAND ALL-WAVE RADIOGRAM (12-550 continuous, 1000-2000 m.)

with R.F. Pre-Amplifier, 2 I.F. stages with Variable Selectivity. Manual R.F. gain control and 10 watts R.C. coupled Triode P.P. Output.

Readers need no introduction to this most popular model, so favourably reviewed by the *Wireless World* on Jan. 5th last. Basically, it remains the same but the frequency response has been still further improved to conform to the higher standard of quality 17 gns. we have set ourselves this year.

Illustrated Art Catalogue giving full specification and details of our 8 Models will be sent upon request.

All chassis on 7 days' approval carriage paid.
12 MONTHS' GUARANTEE.

ARMSTRONG MANUFACTURING CO.
WALTERS ROAD, HOLLOWAY, LONDON, N.7.
(Adjoining Holloway Arcade.) Phone: NORth 3213.

NUMBERED ADDRESSES

For the convenience of private advertisers, letters may be addressed to numbers at "The Wireless World" Office. When this is desired, the sum of 6d. to defray the cost of registration and to cover postage on replies must be added to the advertisement charge, which must include the words Box 000, c/o "The Wireless World." All replies should be addressed to the Box number shown in the advertisement, c/o "The Wireless World," Dorset House, Stamford Street, London, S.E.1. Readers who reply to Box No. advertisements are warned against sending remittances through the post except in registered envelopes: in all such cases the use of the Deposit System is recommended, and the envelope should be clearly marked "Deposit Department."

DEPOSIT SYSTEM

Readers who hesitate to send money to advertisers in these columns may deal in perfect safety by availing themselves of our Deposit System. If the money be deposited with "The Wireless World," both parties are advised of its receipt.

The time allowed for decision is three days, counting from receipt of goods, after which period, if buyer decides not to retain goods, they must be returned to sender. If a sale is effected, buyer instructs us to remit amount to seller, but if not, seller instructs us to return amount to depositor. Carriage is paid by the buyer, but in the event of no sale, and subject to there being no different arrangement between buyer and seller, each pays carriage one way. The seller takes the risk of loss or damage in transit, for which we take no responsibility. For all transactions up to £10, a deposit fee of 1/- is charged; on transactions over £10 and under £50, the fee is 2/6; over £50, 5/-. All deposit matters are dealt with at Dorset House, Stamford Street, London, S.E.1, and cheques and money orders should be made payable to Iliffe & Sons Limited.

SPECIAL NOTE.—Readers who reply to advertisements and receive no answer to their enquiries are requested to regard the silence as an indication that the goods advertised have already been disposed of. Advertisers often receive so many enquiries that it is quite impossible to reply to each one by post. When sending remittances direct to an advertiser, stamp for return should also be included for use in the event of the application proving unsuccessful.

NEW RECEIVERS AND AMPLIFIERS

*
*
CHALLENGER RADIO CORPORATION "Degallier's." Send 2d stamp for handsome illustrated catalogues telling of our superb range of 1940 fully guaranteed receivers; direct to public sales policy saves you 40%; sets to suit every pocket from 65/- to £31/10. Sale list also available upon request.—Challenger Radio Corporation, "Degallier's," 31, Craven Terrace, London, W.2. Paddington 6492. Nearest point, Lancaster Gate Tube. [8751]

RADIO CLEARANCE, Ltd., 63, High Holborn, London, W.C.1. 'Phone: Holborn 4631.

GUTHNAN MCMURDO Silver Super Silver Communication Receiver.

AS Described in Previous Issue of This Magazine. Circuit, superhet, double regeneration obtained at signal frequency and also at intermediate frequency, as a result very high sensitivity and selectivity are obtained; controls include R. meter, silencer, tone, aerial trimmer, A.F. gain selectivity, beat oscillator, receive-send, A.V.C., B.F.O., on-off, B.F.O. pitch, assembled with valves but unwired, £17; wired and aerial tested, £18/18.

A MAZING Offer for One Month Only.

BRITISH Belmont 9-valve A.C. Superhet Chassis, complete with Mullard valves, four wave bands, covering 6-2,000 metres, complete with escutcheon and all necessary parts for fixing into cabinet, £57/7/6 each; complete in De Luxe cabinet with speaker, £77/7; speaker matched for use with above chassis available at 15/- each extra.

RADIO CLEARANCE, Ltd., 63, High Holborn, London, W.C.1. 'Phone: Holborn 4631. [8786]

A MAZING Offer—Famous 7-valve push button 1939 A models in makers sealed cartons, issued 13½ gns.; £5/19/6; list free.—Shippers, 18, Corporation St., Manchester. [0639]

ARMSTRONG Co.—After many years at our old premises at Camden Town we have removed to a new building in Walters Rd., Holloway, N.7 (see displayed advertisement).

ARMSTRONG Amplifier Division Has Removed to New Premises at 94, Camden Rd., N.W.1. In addition to our standard range of 6- and 12-watt push-pull high fidelity amplifiers and local station feeder units, we manufacture equipment for special purposes, pre-stage units, electronic mixers, tone control units, etc.

ARMSTRONG Are Always Pleased to Assist in the Solution of Special Problems; details of standard equipment free on request.

ARMSTRONG Co. (Amplifier Division), 94, Camden Rd., N.W.1. [8752]

£5/15—Ambassador 6778 Universal 7-valve chassis and speaker (10in.), four band, R.F. stage; a few only, being surplus production, at this low price; cash with order, money refunded if not genuinely satisfied.—Ambassador Radio Works, Hutchinson Lane, Brighouse, Yorks. [8812]

USED SETS FOR SALE

HALLICRAFTER

HALLICRAFTER Sky Champion, new 1939 model; £13/13-6, Elizabeth Ave., Christchurch, Hants. [8790]

"**HALLICRAFTER** Sky Challenger," new condition, guaranteed; £15 or would exchange for any American multi-valve receiver.—Box 765, c/o *The Wireless World*. [8793]

H.M.V.

H.M.V. Model 508, 1936, 10 valves with push-pull output, current type automatic record changer, cost £55, perfect working order; accept £25; convertor for D.C. mains available extra.—Brewer, Bethcar St., Ebbw Vale. [8791]

MIDWEST

MIDWEST 18-valve 6-waveband Radiogram, Garrard record changer, list price 87 gns.; £35 or near offer. **G. W. SMITH and Co. (Radio), Ltd.**, 6, Pentonville Rd., N.1. Tel. 6751. [8811]

STROMBERG-CARLSON

STROMBERG-CARLSON 75 Gns. 14-valve Console, with acoustical labyrinth, five wavebands, 5 to 2,000 metres, 20 watt output, used for demonstration only; £25.—Portland Radio, 15a-6, Great Portland St., W.1. [8803]

W.W. QUALITY AMPLIFIER

W.W. Q.A.; nearest 45/-; seen working any time.—Crutenden, 69, Raligh Rd., Feltham, Middlesex. [8800]

CAR RADIO

A LL Goods Previously Advertised Still Available.
HENRYS, 72, Wellington Ave., Stamford Hill, N.15. Stamford Hill 2907. [8745]
1939 Models from 4½ gns., 6 new car aeriels, from 2/6; trade enquiries solicited; lists free.—Shippers, 18, Corporation St., Manchester. [0622]

PUBLIC ADDRESS

TANNOY 25-watt Amplifier, Ad-on-Unit, A.C. mains, complete; £10.—Esaco, 18w, Brixton Rd., S.W.9. [0643]

"**PARTRIDGE P.A. Manual**," standard handbook on electro-acoustics, amplifiers, and audio circuits; price 2/6 (free to trade).

PARTRIDGE Amplifier Circuits, describes many modern constructional amplifiers, 2w. to 45w. output, battery, A.C./D.C., etc.; price 2/- (no free copies).

PARTRIDGE, N. B.Sc., A.M.I.E.E., King's Buildings, Dean Stanley St., London, S.W.1. [0630]

PUBLIC ADDRESS

VORTEXION P.A. Equipment. **I**MITATED, but unequalled. **W**E Invite You to a Demonstration.

A.C.-D.C. Dance Band Amplifier, 10 watts output, complete in case, with moving coil microphone, speaker and cables, weight 22lb.; 12 gns.

A.C.-20 15-20-watt Amplifier, 38-18,000 cycles, independent mike and gram, inputs and controls, 9037 volts required to full load, output for 4, 7.5, and 15 ohms speakers, or to specification inaudible hum level, ready for use; 8½ gns., complete.

C.P. 20 12-volt Battery and A.C. Mains Model, as used by R.A.F., output as above; 12 gns.

A.C.-20, in portable case, with Collard motor, Piezo pick-up, etc., £14; C.P.20 ditto, £17/17.

50-WATT Output 6L6s, under 60-watt conditions, with negative feed back, separate rectifiers for anode screen and bias, with better than 4% regulation level response, 20-25,000 cycles, excellent driver, driver transformer, and output transformer matching 2-30 ohms impedance electronic mixing for mike and pick-up, with tone control, complete with valve and plugs; £15.

COMPLETE in Case, with turntable, B.T.H., Piezo pick-up and shielded microphone transformer; £20.

80-WATT Model, with negative feed back; £25, complete.

120-WATT Model, with negative feed back; £40, complete.

250-VOLT 250 m.a. Full Wave Speaker field supply unit; 25/-, with valve.

ALL P.A. Accessories in Stock; trade supplied.

VORTEXION, Ltd., 182, The Broadway, Wimbledon, S.W.19. Phone: Lib. 2814. [8241]

ALXANDER BLACK, Ltd., Established 1925.—For microphone equipment when quality counts. Booklet on request.—55, Ebury St., S.W.1. Sloane 6129. [0596]

PUBLIC Address Contractors Can Hire P.A. Vans, loud speakers, microphones and equipments of all types from Hire Dept., Grampian Reproducers, Ltd., Kew Gardens, Surrey. Tel.: Richmond 1175-6-7. [0618]

NEW MAINS EQUIPMENT

VORTEXION Mains Transformers, chokes, etc., are supplied to G.P.O., B.B.C., L.P.T.B. Why not you?

VORTEXION, Ltd., 182, The Broadway, Wimbledon, London, S.W.19. Telephone: Liberty 2814. [8772]

NEW LOUD-SPEAKERS

SINCLAIR Speakers for All Types.—Pulteney Terrace, Copenhagen St., N.1. [0603]

BAKERS New Corner Horn Speakers, Triple cone conversions; from 29/6, and surplus speaker bargains.—Bakers Selhurst Radio, 75, Sussex Rd., South Croaydon. [8728]

SAVE Pounds.—1½d. stamp for list British and American P.A. Speakers. Example: P.A. unit with transformer weighing 23lb., incorporating curved cone, 47/-.—Degallier's, 31, Craven Terrace, London, W.2. [8814]

LOUD-SPEAKERS

SECOND-HAND, CLEARANCE, SURPLUS, ETC.

3,000 Speakers from 5/6 each, P.M. and energised 4in. to 14in., including several Epoch 18in.—Sinclair Speakers, Pulteney Terrace, Copenhagen St., N.1. [0591]

TELEVISION

H.M.V. 29 Gns. All-wave Receiver, as new; £20.

HENRYS, 72 Wellington Ave., Stamford Hill, N.15, Stamford Hill 2907. [8746]

COSSOR Model 137T Combined Radio and Television, 10in. x 8in. picture, cost 70 gns., used for demonstration only; £35.—Portland Radio, 152-6, Great Portland St., W.1. [8802]

WANTED Immediately.—Baird grid cell type Kerr cells complete with polarising prisms, full price paid for unit in perfect condition.—Physical Laboratory, The University, Aberdeen. [8787]

TRANSMITTING APPARATUS

A.C.S. RADIO, specialists in short wave apparatus, communication receivers, including Hallicraeters, National and R.M.E. transmitting equipment, valves and components. Send for free catalogue to A.C.S. Radio, 16, Gray's Inn Rd., W.C.1. Holborn 9394-5. G2NK, Technical Manager. [0550]

G5N1—The oldest and largest distributor of amateur equipment transmitting and receiving; short-wave catalogue, 1½d. G5N1 70-page Manual, 7½d., post free; authorised direct distributor for Collins, National, R.M.E., Thordarson, Hammerlund, Bliley, Taylor, Elmac, etc., etc.—44, Holloway Head, Birmingham. [0531]

CABINETS

A CABINET for Every Radio Purpose.

CONVERT Your Set into a Radiogram at Minimum Cost; surplus cabinets from noted makers under cost of manufacture (undrilled); 30/- upwards; motors at wholesale prices.

"FITA-GRAM" Cabinet, 31x17x15, 21/-.

UNDRILLED Table Console and Loud-Speaker Cabinets from 3/6.

INSPECTION Invited; photos loaned to country customers.

H.L. SMITH and Co., Ltd., 289, Edgware Rd., W.2. Tel.: Pad. 5891. [0485]

Get your new **ARMSTRONG CHASSIS** on **L.R.S. EASY TERMS**

Natural Reproduction (not "tone") is the outstanding feature of the new Armstrong Models (see advt. opposite). Their latest achievement—The "Superhet-Straight"—demands the attention of all lovers of Quality.

Illustrated literature giving full particulars of all models will be sent free upon request, with details of our simple monthly terms.

FULL RANGE IN STOCK. **WRITE TO-DAY!**

In addition to the Armstrong range, we shall be glad to quote for all other high grade equipment, such as Sound Sales Amplifiers, Haynes Radio, Voigt Speakers, Avometers, etc.

Estd. — 1925 THE LONDON RADIO SUPPLY COMPANY 'Phone NATIONAL 6828
11 OAT LANE NOBLE ST LONDON EC2

For PROMPT DELIVERY of High Quality

LOUDSPEAKERS, LOUD-SPEAKER CONES, LOUD-SPEAKER COMPONENTS, TRANSFORMER LAMINATIONS, TRANSFORMER HOUSINGS, TRANSFORMER WINDINGS, CHOKE WINDINGS, FIELD COIL WINDINGS, PERMANENT MAGNETS, PRESS TOOLS AND PRESSINGS, JIG BORING, AUTOMATIC SCREW MACHINE PARTS UP TO 2" DIAMETER.

Contractors to the Admiralty, War Office and Air Ministry.

Call on **BRITISH ROLA LTD.**
MINERVA ROAD, PARK ROYAL, N.W.10.
PHONE: WILLESDEN 4322-3-4-5-6

Pamphonic AMPLIFIERS
Pamphonic Reproducers Ltd. (Associated with P.Y.E. Ltd.)
45, St. Pancras Way, London, N.W.1.
Phone: EUSton 1727.

PREMIER RADIO STOCKTAKING SALE FINAL SALE OFFERS!

BATTERY CHARGERS for A.C. Mains, 2 volts, ½ amp. Metal Rectification, 10/-.

POTENTIOMETERS WITH SWITCH, ½ meg., ¼ meg., 20,000 ohms and 10,000 ohms, 1/3 each.

POTENTIOMETERS WITHOUT SWITCH, 2 meg., 1 meg., ¼ meg., 400,000 ohms, 25,000 ohms, 20,000 ohms, 10,000 ohms, 1/- each.

SPECIAL OFFER—CONTINENTAL MAINS VALVES, 4 v. AC Types, 5-pin only, AC/HL, AC/L, AC/P, AC/SG, AC/VMS, AC/HP, AC/VHP, 2/6 each.

F.W. RECTIFIERS 350v. 120ma., 4/6; 500v. 120 ma., 5/6.

20 v. 18a AC/DC Types, SG. Var. Mu., SG. Power, HF Pen., 2/- each.

U.S.A. Types, 24, 30, 41, 39/44, 35/51, 55, 56, 57, 58, 71, 77, 78, 85, 2A5, 2A6, 2A7, 2B7, 6A7, 12Z3, 210, 250, all 2 for 3/-.

TUBULAR CONDENSERS, .002, .0001, .0003 and .0005 mfd., 1/- doz. Your choice

ELECTROLYTIC CONDENSERS. Metal Can. 8 mf. 320 volts, 2 for 1/6. 8+8 mf. 475 v. +10 mf. 50 v., 2 for 2/6. 8+8 mf. 450 v. +8 mf. 250 v., 2 for 2/6.

T.C.C. DRY ELECTROLYTICS. 8+8+4 mf. 500 v. 2/- each.

500 v. CARDBOARD ELECTROLYTICS. 4 mf. or 8 mf. 1/6. 8+4 mf. 2/9. 8+8 mf. 2/6. 4+4 mf. 2/4.

MAINS TRANSFORMERS — MANUFACTURERS' SURPLUS. 250—250 v. 60 ma., 4 v. 2 a., 13 v. 1 a., 3/6.

GARRARD AUTO CHANGERS, Model RC.4 for A.C. Mains, 250-250 v., plays eight 10" or 12" Records. Limited quantity only to clear at **£5.50**.

NOW READY PREMIER 1940 CATALOGUE

112 illustrated pages. Over 20 pages of British and American Valve Data. Bigger and Better than Ever! **GET YOUR COPY NOW.** Price 6d.

Huge Reduction in Prices of TRIAD U.S.A. VALVES from 2/3 each!

PREMIER SHORT-WAVE KITS.

Complete to the last detail including all Valves and coils, as well as theoretical and wiring diagrams and lucid instructions for building and working. Each kit is supplied with a steel Chassis and Panel and uses plug-in coils to tune from 13 to 170 metres.

1 Valve Short-Wave Receiver or Adapter Kit ... 17/6

1 Valve Short-Wave Superhet Converter Kit ... 20/-

1 Valve Short-Wave A.C. Superhet Converter Kit 22/6

2 Valve Short-Wave Receiver Kit ... 25/-

3 Valve Short-Wave Screen Grid and Pentode Kit 58/6

PREMIER U.S.A. QUARTZ TRANSMITTING CRYSTALS 7 mc Band, 10/- each, with Calibration Certificate. Enclosed holder and base, 3/-.

MORSE KEYS. Excellent brass movement on bakelite base, 2/9 each.

PREMIER SHORT-WAVE COILS, 4- and 6-pin types, 13-26, 22-47, 41-94, 78-170 metres, 1/9 each, with circuit. Special set of S.W. Coils, 14-150 metres, 4/- set, with circuit. Premier 3-band S.W. coil, 11-25, 19-43, 38-86 metres. Suitable any type circuit, 2/6.

UTILITY Micro Cursor Dials, Direct and 100:1 Ratios, 3/9.

PREMIER Short-Wave Condensers, all-brass construction, with Trolitol insulation. 15 mmf., 1/6; 25 mmf., 1/7; 40 mmf., 1/9; 100 mmf., 2/-; 160 mmf., 2/3; 250 mmf., 2/6.

TROLITOL DOUBLE SPACED TRANSMITTING CONDENSERS. 15 mmf., 2/9; 40 mmf., 3/6; 100 mmf., 4/-; 160 mmf., 4/6.

COIL FORMERS, 4- or 6-pin low-loss, 1/- each.

Orders 5/- and over sent Post Free. Under 5/- please add 6d. Postage.

"CLASS B" KITS, comprising driver transformer, 2 volt Class B Valve and holder, with circuit. 10/- complete.

MAGNAVOX 3" P.M. MOVING COIL SPEAKERS, with Output Transformer, 10/6 each.

ALL POST ORDERS TO: Jubilee Works, 167, Lower Clapton Road, London, E.5. Amherst 4723.

CALLERS TO: Jubilee Works, or our NEW PREMISES 169, FLEET STREET, E.C.4. Central 2833 or 50, High Street, Clapham, S.W.4. Macaulay 2381

A.R.P. AND OTHER VENTILATION

Your Dug-out may be fuggy.

"LESDEX" MOTOR BLOWERS for suction or pressure. 20 cubic feet free air per minute, all aluminium and ensures adequate ventilation. Suitable for blowing and cooling purposes, Porthole or baffle board fixing. Size only 9".

A.C. or D.C. Mains. Bargain Price **25/-**

± H.P. Direct Coupled Sirocco Blowers A.C. or D.C., 25 ft. air 2½" outlet **50/-**.

Compressors for Spray Work, hand or motor, cheap.

LESLIE DIXON & CO., 218, Upper Thames St., E.C.4

ELECTRADIX

VIBRATOR BATTERY SUPERSEDER, with metal rectifier, for H.T. from your 2-volt battery, 3 output volt tappings. Reduced from £3 15s. to sale price, 35/-.

CRYSTAL SETS, plug-in coils, 2 tuning condensers, semi-perm. Detector, 5/6. One for your A.R.P. shelter. Cheap.

A.R.P. VENTILATION AND AIR CONDITIONING, AC or DC mains, 80 watts, 9in. blower, 20 cub. ft. free air per min. Only 25/-.

A.R.P. ACCUMULATORS at 6d. per cell, 3 amp. standby for HT in 24 volt 3 A.H. crater. Solo units. Suit parallel 12 volt charging. Only 6d. per 2-volt cell. Any value up to 480 volts. Great bargain at 3d. per volt.

LARGE IMMERSION HEATERS for tank or bath, 1,000 watts. With flex. cord, 25/-.

MODEL D. BUZZERS for Morse Practice, 1/-; Buzzers for Signals 1/-; Buzzers to replace Bells, 1/-; Buzzers for circuit testing, 1/-. All British make, 1/-; Bell Bobbins, small twin, 2-pole, 8d.

MORSE PRACTICE SETS, No. 3, with key buzzer and lamp for sound and visual, line plug, etc., 7/-; Sound Type, 1A type key and buzzer, 3/-; Visual Type 2A, key and lamp, 2/-.

ALARM BELLS, Small and large. Battery or mains DC or AC 10in. 100w. Domestic Bells and Fire Bells, cheap. Please state wants. Single Bell Wire, 1/- per 100 yds.

RESISTANCE WIRE AND SLIDER KIT. Bargain! 45 gauge Eureka, enamelled, 108 ohms, per yd. 1 lb. approx. 300,000 ohms, 3/-.

36 gauge Eureka ditto, for 100 m/a 1 lb. approx., 8,000 ohms, 1/-.

33 gauge Eureka, ditto, for 250 m/a, 1/-.

29 gauge Eureka, ditto, 1 lb. for 1/-.

27 gauge Eureka, ditto, for 1 amp., 1 lb., 10d. Post extra.

RHEOSTAT KITS. We are frequently asked for kit of parts to make sliding resistances and dimmers and now offer Slider Res. Kits, 250 watt size. Porcelain steel tube, 2 1/2 in. x 6 in. Two cast all-end brackets, slider-rod, brush and guide-handle nuts, etc., all new ready for assembly. Bargain at 5/-. Any wire can be supplied, but we offer Oxidized Resistance wire for 100 m/a for 4,800 ohms, 5/-; 110 ohms, 2 amps, 5/-; or any of six other gauges in between. Exceptional bargain to clear surplus stock.

ELECTRIC SOLDERING IRONS. Heavy workshop type, 125 watts, 220/250 volts, 6/6; 100 watts, 3/6.

A.R.P. POCKET HEADPHONES, W.D. all leather headband, strap and cords, 2/6 pair, 120 ohms, with aluminium headbands, 2/9. 4,000 ohms, 4/6. House and Office Telephones, wall and table, cheap. A.R.P. Transportable type, with hand comb, 35/-; Unbreakable Telephone Wire, 15/- per 1 mile.

1,000 EARTH ground spikes for radio or earth return circuit telephones, 8d. each, post 6d. or 6/- doz., car. fwd.

METER MOVEMENTS. Full size, moving coil, P.M., for adapting home-made multi-range testers. For 3in. or 4in. dials, 5/-; post 1/-.

RELAYS. For front or back of panel, microamps or amps. The small current type for photo cells, radio and remote controls, etc. Low, medium or high res. Prices are 1/5 m.a. Moving Iron, 8/6, 10/6 and 12/6. High Grade Moving Coil, 50 microamps, Weston, 60/-; in bronze water-tight case, 70/-; New model W.I. 50 microamps, 11in. panel type, 55/-.

G.P.O. TYPE B TELEGRAPH RELAYS, with platinum points, 7/6. Silvertown Horizontal Galvos, two jewels, 5/-; post 6d. Verticle needle C.P.O. teleg. Galvos, 4/6. Weston zin. dial centre-zero ammeters, read 1 amp. to 15 amp., 5/-.

SPARK OR IGNITION COILS. Remy Plain 4, 6 or 12 v. for sparking plugs, 3/6.

ONE HUNDRED 10-watt Moving Coil Magnets by Darwin. New 4-claw 4 1/2 lb. weight, 4/- each, post 1/-.

5,000 RESISTORS, 1/4 and 1 watt, .01, .025, .05, 1, 5 and 1 meg. Glass bead, wire ends, worth 1/- each, at 1/- per doz., or 9/- gross.

400 VARIABLE CONDENSERS, Weston, 1000 p.m.f., Tekade, 1/3. .0005 Formo, 2/-; 2-gang, 2/6; 3-gang, 3/6.

FIXED CONDENSERS for odd smoothing jobs, 5,000 Mansbridge 1 m.f.d. Condensers to clear at 2/- doz., 20/- gross.



MICRO-AMMETERS for small current Valve Voltmeters, etc. Sensitivity, 0 to 50 microamps full scale, moving coil, panel type, 2 1/2 in. dial. Reads direct 1 micro A. per div. New, 1,000 ohms coil. Cheap at 40/-. Fitted platinum contacts for CZ Relay, 50 microamps, coil, 100 m/a contacts, 55/- only.

AC DC DIX-MIPANTA 196 VALVE ANALYSERS, AC/DC, £5. Cossor Ganging Oscillator, £12 10/-. Post Webber Oscillator, £9 10/-. Baldwin Henlog Inductance Bridge, £8 10/-. Baldwin Mufer, £8. Logohm, 70/-.

TRANSMITTERS, do you measure your aerial current? **H.F. AERIAL RADIATION METERS**—Flat panel, 2 1/2 in. dial, Hot wire, 4-500 m.a., 7/6; 0 to 2 amps, 12/6; 0 to 2 1/2 amps, 12/6. 3in. dial ditto, 6-4 amps, 21/-. Panel 4in. dial, 3 amps, £11 10/-. 7in. dial, 2 to 15 amps, £11 5/-; Thermo-moving Coil Meters, all ranges.

VALVE BARGAINS for Transmitters. Ediswan 30-watt VT13B £2 Valve for 7/6. T50 £3 Valves, 12/6. AT40, 10 watts, 4/-; Hains Universal 7-pin Frequency Changer, 4/6. A.C. ditto, 4/6. Universal H.F. 7-pin Pentode, 4/6. H.T. Rectifiers, 2V, for up to 5,000 volts, 1/2 wave, 250 watts, 35/-; T2A 100 watt ditto, 40/-; U3 1 wave, 20 watts, 2/6.

TELEPRINTER TELEGRAPH—G.P.O. Model for Typewriter transmission. Electrically operated, first-grade workmanship. Two only now. Cost £50. Sale, £4.

MORSE INKER Tape Strip Recorders; portable or table. Cheap. Wheatstone Strip Hand Recorders, 15/-; Paper Tape for Morse and Wheatstones, green or white, 6d. reel. Brass Tape Reels in mahogany case, 2/6.

D.C. GENERATORS, 120 watt 12 volts 10 amps., with vee pulley, 35/-; 1/2 kW. 12/16 volts 30 amps., with vee pulley, 45/-; Shunt wound—110 volts 1 amp., 15/-; 200 volts 1/2 amp., 17/6; 200 volts 1 1/2 amp., 26/-.

D. WINDMILL GENERATORS, totally enclosed, ball-bearing, start charging at 300 revs., 12 volt, 8 amps., 35/-; 25 amps., 45/-.

AS NEW E.D.C. ROTARY CONVERTERS—For A.C. Receivers, on D.C. 230 v. A.C. output. In silence cabinet, with filter. All sizes in stock from 50 watts to sets for televisors of 450 watts.

5/- PARCEL of 10 lbs. of servicing components; resistances, tubulars, micas, variables, wire, sleeving, vol. controls, coils, magnets, chokes, switches, mouldings, terminals, etc., post free; 10 lbs., 5/-.

Over 1,000 other Bargains in our enlarged Illustrated 1939 List "W"

ELECTRADIX RADIOS
218, UPPER THAMES STREET, LONDON, E.C.4
Telephone: Central 4611

Do quite a lot of business making up transformers to customers' own specifications; but we have a standard list. May we send you a copy?

W. BRYAN
WESTMORELAND RD., LONDON, N.W.9

SAVAGE LTD
PHONE COLINDALE 7131

BOOKS ON WIRELESS
Write for complete list to
Iliffe & Sons Ltd., Dorset House, Stamford St., London, S.E.1
W.W.1

Books on Wireless
Iliffe & Sons Ltd., Dorset House, Stamford St., London, S.E.1
W.W.1

Books on Wireless
Iliffe & Sons Ltd., Dorset House, Stamford St., London, S.E.1
W.W.1

"Radio Laboratory Handbook." Price 8s. 6d. net. Post free 9s.

CABINETS

DEGALLIER'S for the Finest Obtainable American Cabinets, Table, Console and Radio Grams; also Record Changers, 5 gns. Send 1/6d. stamp for reprints from actual photog. aphs—Degallier's, 31, Craven Terrace, Lancaster Gate, London, W.2. Paddington 6492. [8815]

DYNAMOS, MOTORS, ETC.

NEWTON Battery Charging Plant, 200-250 volt, 1/2 to 6 amps., 4 circuits; price £10, or offer.—Caldwell, 38, Drumtrocher St., Kilsyth. [8794]

ALL Types of Rotary Converters, electric motors, battery chargers, petrol-electric generator sets, etc., in stock, new and second-hand.

A.C.-D.C. Conversion Units for Operating D.C. Receivers from A.C. Mains, 100 watts output, £2/10; 150 watts output, £3/10.

WARD, 46, Farringdon St., London, E.C.4. Tel.: Holborn 9703. [0518]

E.D.C. Converter, 220 250 D.C. input, 230 A.C., 180 watts output, with filter in cabinet, as new, £3.—Brewer, Bethcar St., Ebbw Vale. [8792]

RECORDING EQUIPMENT

ALL Recording Discs and Materials in Stock, tracker units, £4/7/6; recording motors, £3/17/6.—Write for further details, Will Day, Ltd., 19, Lisle St., W.C.2. [0595]

FEIGH Recording Sets are Within Reach of All; ball bearing gear box, worm drive traverse; records on any disc, Morse, speech or music; diamond cutter-pickup on tone arm, the set 37/6; 6in. blanks, 3/3 doz.; 10in. discs, 7/- doz.—Electradix, 218, Upper Thames St., London, E.C.4. [0620]

VALVES

ALL Types of American Tubes in Stock of Impex and Arcturus makes at competitive prices.

WE Can Also Supply a Full Range of Guaranteed Replacement Valves for Any British non-ring, American or Continental type at an appreciably lower price.

SEND for Lists of These, and also electrolytic condensers, line cords, resistances, etc.

CHAS. F. WARD, 46, Farringdon St., London, E.C.4. Tel.: Holborn 9703. [0452]

AMERICAN, 2/9; 1,000 non-ring British from 1/9; bargains galore; lists free.—Shippers, 18, Corporation St., Manchester. [0607]

METROPOLITAN RADIO SERVICE—Special offer, American valves in makers' cartons, 3/- each, Octals, 5/6 each; American valves, first grade, in all types; trade supplied.—1021, Finchley Rd., N.W.11. Speedwell 3000. [0436]

COMPONENTS

SECOND-HAND, CLEARANCE, SURPLUS, ETC.

PREMIER SUPPLY STORES.

PLEASE See Our Displayed Advertisement on page 5. [0488]

RYALLS RADIO, 280, High Holborn, London, W.C.1, offer new goods, post free.

ELLIPTICAL Speakers, Celestion, suitable Ekco replacements, 750 and 1,250 ohms, less transformers, speech 25 ohms, new, handle 8 watts, carry up to 120 m.a.; 5/6 each.

AMPLIFIERS, A.C. 200-250v. output 16 watts A.C. from pair 6L6 push pull, 3 stage, ample volume for driving extra speakers available. Complete with valves, and pair of elliptical speakers, wired up ready for use; 72/6, carriage paid.

SPEAKERS, pairs, brand new, elliptical cone speakers, made by first class firm, quality of reproduction outstanding. Push-pull pentode transformer, fields 325 ohm for smoothing choke, 8.600 as bleeder, circuit available, handle 10-15w.; 14/- pair.

HEAVY Duty Mains H.F. Chokes, Goltone. 75w. high inductance type, 1/6; 180w. low inductance type, 1/-.

MAINS Transformers, drop through chassis type, top cover with mains adjustment, input 200-250v., outputs 350-350, 80 m.a. 4v. 2 1/2a. 4v. 4-5 amp., heavy jobs, 6/9 each.

MAGNAVOX 7in. Core Speakers (8in. overall), ribbed pattern ideal replacement speakers, 2,000 ohms pentode transformers; 7/-, new.

SATOR 1/2meg. Pots with Switch, 1/3 each, 7/9 dozen; 10,000 ohm broad base tone control type, less switch, 1/3 each, 6/9 dozen.

AMPLIFIERS for A.C. 200-250v. Input, 3-stage single 6L6 output, with pair energised elliptical speakers, and Ferranti output transformer, output 12 watts; 47/6, all wired complete with valves and speakers. [8809]

VAUXHALL—All goods as previously advertised still available; write for free list.—Vauxhall Utilities, 163a, Strand, W.C.2. [8727]

PRETUNED Quality Receiver, transformer, 40/-; chokes, 20 lb., 12/6; 10 lb., 17/6.—W. A. Davis, A.M.I.W.T., 6, Oxford St., Newcastle. [8806]

SOUTHERN RADIO, 46, Lisle St., London, W.C. Gerard 6653.—Stocks of receivers and replacement components, as previously advertised. [8548]

OLIVERS Offer Aluminium Chassis, 16in. x 10in. x 3in., 18 S.V.G., 6/6; any size to order, quotations free.—Olivers, 676, Christchurch Rd., Boscombe, Hants. [8801]

COULPHONE RADIO for Best Bargains Car Radios, receivers, loud speakers, accessories, American and British non-ring valves, electrical goods; car radios, single wave, £4/4; remote control, £7/7; dual wave push button, £5/15/6; American valves, all types, 3/- each; Octal, 3/6, including 6L6G; 1/4d. stamp for catalogues.—Coulphone Radio, Ormskirk, Lancs. [8799]

Why Solon Electric Soldering is easier

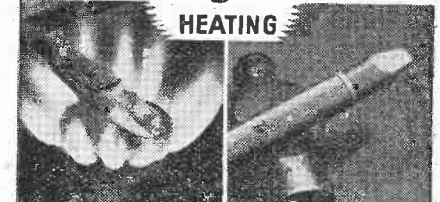

IRREGULAR HEAT IRON COOLS OFF
CONSTANT HEAT IRON COOLS OFF

Cleanliness and constant heat are the secrets of successful soldering. The Solon is heated by the element clamped inside the bit. Ready in 4 minutes, maintaining constant heat at the point. 15 hours' use for 1 unit.

Supplied complete with resin-cored solder, flex and lamp adaptor, 8/6.

Solon resin-cored solder, 6d. per reel.



W. T. Henley's Telegraph Works Co. Ltd. (Dept. 1/E), Holborn Viaduct, London, E.C.1.

GET 2 YEARS FREEDOM FROM NEEDLE CHANGING

with the **GENUINE Walco Sapphire** GRAMOPHONE NEEDLES

More than 2,000 playings from one needle, a minimum of record wear, and greatly improved reproduction are obtained from the new Walco Needle—price 12/-. Order now or write for FREE BOOKLET "SOUND REPRODUCTION" from

R.A. Rothermel LTD
(Dept. G)
Canterbury Road, High Road, Kilburn, N.W.6

ENGINEERS! ARE YOU EARNING LESS THAN £10 PER WEEK?

If so, you cannot afford to carry on without reading our 268-page Handbook. The book explains clearly and definitely many ways of carving out a successful career. Among other things it explains the Services of our unique Appointments Department: outlines Home-Study Courses in all branches of Civil, Mechanical, Electrical, Motor, Aero, Wireless, "Talkie" Engineering, Building, Govt. Employment, etc., and gives details of B.Sc., A.M.I.C.E., A.M.I.E.E., A.M.I.Mech.E., A.M.I.A.E., A.M.I.W.T., A.M.I.R.E., G.P.O., MATRIC., and all Exams. We Guarantee — "NO PASS—NO FEE." Whether you be an old hand or a budding apprentice get this book to-day. FREE and POST FREE.

BRITISH INSTITUTE OF ENGINEERING TECHNOLOGY
367, Shakespeare House, 17/19, Stratford Place, London, W.1.



COMPONENTS—SECOND-HAND CLEARANCE, SURPLUS, ETC.

R.
RADIO CLEARANCE, Ltd.
63 High Holborn, W.C.1. Phone: Holborn 4631.
FILAMENT Transformers.—In-put 200-250 volt, out-put 4 volt, 4 amps., 4 volt 6 amps., 4/11 each.
MAINS Transformers.—American windings. In-put 200-250 volt, tapped. Out-put 350-0-350. 100 m.a. 5 volt 2 amp. 6.3 volt 5 amp.; 7/11 each.
GE.C. Mains Transformers.—American windings. 350-0-350 volt. 65 m.a. 5 volt, 2 amp. 6.3 volt. 2.5 amps.; suitable for replacements in G.E.C. models; 5/6 each.
AUTO Transformers.—100-230 volt; 5/11.
ELECTROLYTIC Condensers.
PLESSEY 8x4x4x4 mid. 570 volt working; 2/- each.
PLESSEY 24 mid. Can type electrolytics, 450 volt working; 10d. each.
T.C.C. 8 mid. Can type Wet Electrolytics, 450 volt working; 1/3 each.
PLESSEY Electrolytic Condensers, 8x8 mid., 450 volt working; 1/- each.
POLAR N.S.F. Resistances.—1 gross parcels of 1/2 and 1/4 watt resistances, all good sizes, our selection; 4/6 each.
PRESS Button Units, with 6 press buttons ready for wiring into set, with circuit; 6/11 each.
BULGIN.—20,000 ohms wire wound pots; 1/- each.
STRANDED Push Back Wire; 1d. yd., 12 yds., 10d.
YAXLEY Switches.—2 pole, 4 way, 3 bank; 1/6 each.
YAXLEY Switches.—2 pole, 5 way, 4 bank; 2/- each.
AMERICAN Chassis Mounting Valve Holders.—4, 5, 6 and 7 pin; 3d. each.
OCTAL Chassis Mounting Valve Holders.—4d. each.
7-Pin English Type Valve Holders. Chassis mounting; 2d. each.
RAYTHEON 76 Valves; 1/6 each.
FULL Range of Raytheon Valves in Stock.—Most competitive prices. For example:—
80—2/9 each.
43—4/- each.
6D6—4/- each.
6C6—4/- each, etc.
SEND for Complete Price List of Raytheon Valves.
SET of Three Manufacturers' Type All-wave Coils, 13-2000 metres, including oscillator, aerial and H.F., with three-gang straight condenser, 2/6 each; wave change switch for above, 2/- each.
ROTHEMEL Piezo Crystal Speakers.—7 1/2 in. cone; list 55/-, our price, 9/6 each.
CO-AXIAL Cable, finest quality, for television, lead in, etc.; single 6d. per yd., double 9d. per yd.
HEAVY Duty Speech Transformers, type O.T.4, primary 462 ohms, secondary 0.3, 20 henrys.
TYPE O.T.5, primary 487 ohms, secondary 0.7 ohms, 20 henrys; 2/11 each.
RADIO Clearance, Ltd., 63, High Holborn, London, W.C.1. Telephone: Holborn 4631.
ALL orders over 5/- carriage free; under this amount, sufficient postage must be included with order.
ALL Enquiries Must Enclose 1 1/2d. stamp. [8785]
MAINS RADIO DEVELOPMENT COMPANY Offer Immediate Carriage Paid Delivery, call mornings. Telephone Tudor 4046. Stamp for List 22s.
MICA Tag Condensers, 0.0001 to 0.002 T.C.C., Ormond, etc., six different sizes in each parcel of twelve for 1/-, thirty for 2/-.
ERIE One-watt, colour coded unused resistors, any size, 50 ohms to 5 megohms, your selection, 3d., 2/6 dozen; two-watt, 6d.
CENTRALAB Latest Potentiometers, long standard spindle, unused, all sizes, 5,000 ohms to 2 megohms, 2/-; with switch, 2/3.
TUBULAR Condensers, 400v. working, wire ends, best make, 0.0001-0.05 mid., 4d.; 0.1 mid., 4d.; 0.25, 0.5 mid., 6d.
CLIX Unused Chassis Valve-holders, 5-pin, 7-pin, 3d.; American sizes, 6d.; best sleeving, 1 1/2d. yard.
FIFTY Unused N.S.F. 1 1/2, 1, 2 watt resistors, wire ends, marked and colour coded, 20 different useful sizes in each parcel; 50 for 2/6.
MAINS RADIO DEVELOPMENT COMPANY, 4-6, Muswell Hill Rd., London, N.6. Tudor 4046. [8778]
WIRELESS WORLD Oscillator Battery, 35/-; Radiolab oscillator battery, 35/-; Tungar 60-cell charger, 50/-; Ferranti portable meters, 0.7-5-15-30 milliamps, 0.7-5-15-30 V and 30 milliamperes, 22/6 each; Velex ribbon microphone, 35/-; Beatty washing machine, A.C. 200-220 V, £5/10 or offer.—H. S. Radio, 38, Coleman Fields, Islington, N.1. [8793]
Wanted
WANTED, modern all-wave tuning unit.—J. Hawes, 18, Banningham Rd., Aylsham, Norfolk. [8805]

SOUND SALES
 INEVITABLY THE DESIGNERS' CHOICE

As in the
QUALITY AMPLIFIER
 so in the
PRE-SET QUALITY RECEIVER—
Sound Sales Mains Transformer
Type Q.R./350 is exclusively
specified

The Q.R./350 TRANSFORMER
 is a laboratory type component of super finish with cast aluminium shrouds, and represents the last word in Mains Transformer design

PRICE **£3**

May we send YOU our latest catalogue and technical manual . . . PRICE 6d.

Specified by  the Experts

SOUND SALES
 MARLBOROUGH RD., UPPER HOLLOWAY, LONDON, N.19. (Contractors to the G.P.O., etc.)
 Hours of Business—Monday to Friday, 8.30 a.m. to 6 p.m.
SATURDAYS CLOSED

RADIOMART
 GENE (HAM) LTD.
THE SHORT-WAVE SPECIALISTS

SPECIAL OFFER !!!
 Fully shrouded Transformers by America's largest manufacturer. While they last.
 All 230 v. primary and fully impregnated.
 T28708—375/375 v. 150 m/A., 6.3V6A, 2.5V6A, 5V3A. 15/-
 T19610—350/350 v. 150 m/A., 2.5V6A, 2.5V2A, 5V3A. 12/6
 T2236—375/375 v. 120 m/A., 6.3VCT, 4A, 5V3A. 10/6
 T7326—350/350 v. 100 m/A., 6.3VCT, 3A, 5V3A. 8/6
 T7307—350/350 v. 80 m/A., 6.3VCT, 3A, 5V3A. 7/6
 T7000—320/320 v. 80 m/A., 6.3V4A, 5V3A. 7/6
 T6025—320/320 v. 80 m/A., 2.5V6A, 5V3A. 7/6
 T444910—10V4A Primary Tapped 110—250 v. 5/6
 T1113AB—110/230 v. 500 watt Auto Transformer 29/6
 The following coils are interleaved and impregnated.
 T7007—250 m/A., 135 ohms, 30-12 Hy., cadmium shrouded. 12/6
 T7007A—150 m/A., 250 ohms., 30-12 Hy., cadmium shrouded. 12/6
 100 m/A., 30 Hy., 500 ohms, unshrouded. 4/11
 60 m/A., 15 Hy., 250 ohms. 1/11
HEAVY DUTY TRANSFORMER for models, bulbs, etc. 6 v. 3 a., 2/3.
 4 m.f., 1,500 v. test 500 v. wkg. oil filled condensers, 2/-.
HEAVY DUTY Mains Transformer, worth 45/-, 350-350, 150 m/A., 4 v. 2.5 a., CT, 4 v. 6 a., CT, 12/6; 300-300 v., 80 m/A., 4 v. 3 a., CT, 4 v. 2 a., CT, 6/6. Moving Coil Speaker Transformers power, pentode or push pull 1/11. WB Heavy duty ditto 2/11.
GANG CONDENSERS with Airplane Dial, 8 and 80-1. Cost 35/-. Few only: 4/11. Utility, 7/6. Microdials 3/8.
WB. Sin. PERMANENT MAGNET SPEAKERS AT ONE-THIRD COST! Extension Type (no Transformer), 8/11. Standard Type (with Transformer) 10/6. Energised 8", 1,200 ohms with Transformer, 3/11.
PUSHBACK Wire, 6 yds., 6d., heavy 9d., Resin-coated Solder, 6ft., 6d.; Soldered Flex, single, 6d., yd., twin 9d., yd. Assorted Solder: Taps, 6d. packet. Humdummers 6d. each. Centralab pots, all sizes, 1/6; wtc-ed, 2/-; tubular fuses, 2d. Milliammeter, 25 m.a., upwards 5/9.
VALVES: Reliable replacements for all types, British and American, showing saving of over 50 per cent.
OU. NEW 66-PAGE MANUAL, packed full of valuable information. Communication receivers, transmitters, etc., 7d. post free.
THE NEW RAYMART CATALOGUE shows dozens of New Short-wave Components and is yours for 1d. post free. TRADE ENQUIRIES solicited for all types of communication equipment, transmitters, r.covers, etc.

RADIOMART Telephone: MIDland 3254
 G5N1 (Birmingham) Ltd.
44, HOLLOWAY HEAD, BIRMINGHAM

THE INSTITUTE OF WIRELESS TECHNOLOGY
 (Instituted in 1925. Incorporated.)
PROFESSIONAL MEMBERSHIP
 The advantages of professional membership are open to all qualified wireless engineers.
 Full information, with syllabus, may be obtained from the Secretary, Institute of Wireless Technology, 4, Vernon Place, Southampton Row, London, W.C.1. Phone: Holborn 4879.

REPAIRS AND SERVICE

"SERVICE with a Smile."

AMERICAN Valves, spares, lineords, rewinds, repairs of all types of American and British receivers.—E.R.L., Ltd., 22, Howland St., W.1. Museum 5675. [0434]
LOUND-SPEAKER Repairs, British, American, any make, 24-hours' service; moderate prices.—Sinclair Speakers, Pultney Terrace, Copenhagen St., N.1. [0590]
GUARANTEED Repairs, Any Transformers, choke, motor armature, converter, dynamo, etc., keenest prices, immediate quotation, prompt, dependable service.—See below.
LT.P. (LONDON TRANSFORMER PRODUCTS, Ltd.), Willesden, N.W.10. Willesden 6486 (3 lines). [6892]
MAINS Transformer Service, Repairs, rewinds, or construction to specification of any type, competitive prices and prompt service.—Sturdy Electric Co., Dip-ton, Newcastle-on-Tyne. [0516]
METROPOLITAN RADIO SERVICE.—Guaranteed repairs to American and British receivers; American valves, service parts and rewinds, trade supplied.—1021, Finchley Rd., N.W.1. Speedwell 3000. [0435]
REPAIRS to Moving Coil Speakers a Speciality; cones and coils fitted, fields altered; prices, including eliminators quoted; loud speakers, 4/-; L.F. and output transformers, 4/-, post free, guaranteed satisfaction, trade invited, estimates free; prompt service.—Loud-Speaker Repair Works, 5, Balham Grove, London, Battersea 1321. [0594]

SITUATIONS VACANT

AIR MINISTRY.
CIVILIAN Wireless Instructors Required.
VACANCIES Exist for Civilian Wireless Instructors at the Electrical and Wireless School, Royal Air Force, Cranwell, Lincs. The commencing rate of pay is £4 a week inclusive which may be increased to £4 5s. a week after a short period of satisfactory service. Candidates must be capable of lecturing and must have a sound knowledge of electrical principles and their application to radio and low-power electrical engineering. Applications should be addressed to the Commanding Officer, Electrical and Wireless School, Cranwell, Lincs, giving full particulars as to previous experience, age, etc. Candidates will be required to appear before a Selection Board at the School, for interview and test. The test will include the giving of a lecture on any subject which may be chosen by the candidate, involving the principles of modern radio. Lecturing sequence and style are most important. [0571]
MINISTRY Of Supply.
APPPLICATIONS are Invited for Appointments as Examiners, with electrical or radio experience, in the Inspection Department, Engineer and Signals Stores, Royal Dockyard, Woolwich, S.E.18, for inspection during and after manufacture of electrical or radio equipment.
APPPLICANTS Should Have Experience in Testing and Manufacture of Wireless Apparatus and Components, a thorough knowledge of R.F. circuits, be able to read drawings, circuit diagrams and specifications, and to calibrate precision instruments; experience in cathode-ray apparatus is desirable.
WAGES From 84/- to 96/- per Week for Engineering Mechanics and 65/- to 92/6 per week for Others, according to technical qualifications and classes of work.
THE Posts are unpen sionable; preference will be given to ex-Service candidates, other things being equal.
A FORM of Application Can be Obtained From:—
THE Chief Inspector, Engineer and Signals Stores, Royal Dockyard, Woolwich, S.E.18. [8807]
AIRCRAFT Radio Operators Required.
(A) Full Time. Salary £4/10 to £5 per week, plus 1s. to 2s. per hour flying pay, according to experience.
(B) Part Time. For evening and night flying, rate 13/6 per flying hour. Place of Employment: Portsmouth.
LETTERS of Application Should be Addressed to The Staff Manager, P.S. and I.O.W.A., Ltd., The Airport, Portsmouth, and should give full particulars of experience and copies of references. [8797]
TECHNICIAN for Component Test Bench and Assist Research Department.—Box 654, c/o The Wireless World. [8813]
WIRELESS Engineer, experienced construction, installation, radiotelephony, transmitters and marine direction finders.—Box 644, c/o The Wireless World. [8810]
DRAUGHTSMAN Required (S.W.18 District), conversant with component design for radio transmitter and receiver development work, previous experience essential.—Write, giving age and salary required, to Box 750, c/o The Wireless World. [8796]
TECHNICAL Radio Representative, experienced, to contact manufacturers and services, required by manufacturers of specialised components under new patents; state experience and salary required; this appointment offers unusual opportunities.—Box 751, c/o The Wireless World. [8795]
LABORATORY Assistant (Adult Male) Required by the War Department for the Wireless Department at the Royal Military College, Sandhurst; candidates must have had a good general education, possess a good working knowledge of the principles of electricity and wireless, and be prepared to assist in practical instruction.
PAY (Weekly): 50/-. rising by 2/6 annually to 63/6; post is not pensionable; preference given to ex-Service candidates, other things being equal.
APPLY by Letter, as early as possible, to the Commandant, Royal Military College, Sandhurst, Camberley, Surrey, stating age and giving full particulars of qualifications and experience. [8808]

Second Edition—
Completely Revised

RADIO DATA CHARTS

A
SERIES OF ABACS
providing most of the essential
Data required in Receiver Design

By
R. T. BEATTY, M.A., B.E., D.Sc.

Published from the Offices of
"THE WIRELESS WORLD"

RADIO DATA CHARTS provide designers of wireless apparatus with a ready, convenient means of solving all the more familiar problems connected with the design of modern radio apparatus without having recourse to complicated formulæ and mathematics.

In order to keep abreast of the great advances in wireless communication since the first edition of "Radio Data Charts" appeared, obsolete abacs have been omitted from this second edition and important fresh material added.

By the use of "Radio Data Charts," such abstruse problems as the design of tuning coils are solved almost as easily as the simple applications of Ohm's Law.

(37 CHARTS and 46 Diagrams)

Price 4/6 net
By Post 4/10

From all leading Booksellers or direct
from the Publishers

ILIFFE & SONS LTD.
Dorset House,
Stamford St., London, S.E.1

W.W.93

SITUATIONS VACANT

TECHNICAL Assistant Required to Prepare Specification and Operating Instruction of Electric Instruments, applicants must have had experience in similar capacity; write, enclosing samples of work, stating age, experience and salary required.—Marconi-Ekco Instruments, Ltd., Southend-on-Sea. [8816]

VACANCIES Exist for Civilian Wireless Instructors at the Electrical and Wireless School, Royal Air Force, Yatesbury, Wilts. The commencing rate of pay is £4 a week inclusive, which may be increased to £4 5s. a week after a short period of satisfactory service. Candidates must be capable of lecturing and must have a sound knowledge of electrical principles and their application to Radio and low-power electrical engineering. Applications should be addressed to the Commanding Officer, No. 2 Electrical and Wireless School, Yatesbury, Wilts, giving full particulars as to previous experience, age, etc. Candidates will be required to appear before a Selection Board at the School for interview and test. The test will include the giving of a lecture on any subject which may be chosen by the candidate involving the principles of modern radio. Lecturing sequence and style are most important. [0616]

ELECTRIC DRY SHAVERS

REMINGTON, Rand, Shavemaster, Packard, Casco, Rabaldo.—Trade enquiries to Leonard Heys, 36, Henry St., Blackpool. [0633]

MISCELLANEOUS

CHEAP Printing.—1,000 billheads, 3/6; sample free.—Creteway Press, 18, Buxted, Sussex. [8180]

EVERY Radio Dealer Who is Not a Regular Reader of "The Wireless and Electrical Trader" should send his trade card at once for a specimen copy and full details of the "Trader" Services. "The Wireless and Electrical Trader" has the widest influence, the largest weekly circulation, and is read by all the leading manufacturers and traders. Trade only. 15/- per annum, post free.—Published at Dorset House, Stamford St., London, S.E.1. [0615]

"ENGINEER'S Guide to Success" Shows How to Qualify in Television Radio Engineering and Servicing, sound, recording, wireless communicating, etc., by studying at home with the T.I.G.B. Write to-day for this Great Guide—free—which gives full particulars, contains the world's widest choice of engineering courses—over 200—and alone gives the regulations for qualifications such as A.M.I.E.E., A.M.I.R.E., A.M.L.T.E., A.M.I.W.T., C. and G., etc. Training until successful guaranteed.—The Technological Institute of Great Britain, 82, Temple Bar House, London, E.C.4. (Founded 1917. 20,000 successes.) [8782]

PATENT AND TRADE MARK AGENTS

GEE and Co. (H. T. P. Gee, Mem. R.S.G.B., etc.), 51-52, Chancery Lane, London, W.C.2. Holborn 4547-8. Handbook free. [0001]

TUITION

RADIO Training.—P.M.G. exams, and I.E.E. Diploma; prospectus free.—Technical College, Hull. [0611]

PRACTICAL Radio-Television Instruction, separate courses, servicing, theory, mathematics, beginners; fees moderate; booklet free.—I.P.E., 3, Shirley Rd., London, W.4. [8804]

WIRELESS.—Complete training Marine, broadcast and television; posts waiting; mod. fees; boarders taken; approved college, prosp.—Dept. W, London Radio College, Grove Park Rd., London, W.4. (Chi. 3244.) [0580]

BUSINESSES AND PROPERTY FOR SALE, TO BE LET, OR WANTED

"THE Wireless and Electrical Trader" is an essential part of the equipment of every Wireless Trader; its pages reflect the very latest turn of trade events, and it is read by all the leading dealers and manufacturers, for particulars of businesses offered or wanted. By subscription to the trade only, 15/- per annum, post free.—Send your trade card for specimen copy to Dorset House, Stamford St., London, S.E.1. [0614]

BOOKS, INSTRUCTION, ETC.

AMERICAN Valve Data.—The 200-page Raytheon Data Book gives full characteristics, applications, all types American valves; invaluable to servicemen; post free anywhere; 2/3.—Leonard Heys, 36, Henry St., Blackpool. [0594]

ALL Wireless and Radio Engineering Books Available through new financial terms as low as 2/6 monthly.—Write a card or call personally for details and lists from the Radio Department, Phoenix Showrooms, 66, Chandos Place, Strand. [8623]

"FOUNDATIONS of Wireless." By A. L. M. Sowerby, M.Sc. Second edition. An elementary textbook on receivers. Deals fully with the construction of wireless sets, valves, and the process of detection. Price 4/6 net. By post 4/11, from Iliffe and Sons Ltd., Dorset House, Stamford Street, London, S.E.1.

"RADIO Data Charts." By R. T. Beatty, M.A., B.E., D.Sc. Second edition. A series of Abacs providing most of the essential data required in receiver design and enabling problems to be solved without having recourse to complicated mathematical formulæ. Price 4/6 net. By post 4/10, from Iliffe and Sons Ltd., Dorset House, Stamford Street, London, S.E.1.



MANUFACTURERS' SERVICE

Whatever you want
we can make
and give speedy delivery

Metal Chassis, Cabinets and Sheet Work, Turned and Pressed Small Parts, Transformers and Chokes of all types, R.F. Coils (singly or in sets), Accurate Testing Gear, Quartz Crystals, Radio Chassis, Tuning Packs, Amplifiers, Microphones, Cellulose and Crystalline spraying, Spot and Oxy-welding, etc., etc.

Quantity Enquiries Invited.

JOHN McCLURE LTD (G6JM)
ERSKINE ROAD, LONDON, N.W.3. PR1 1030 S435

INDEX TO ADVERTISEMENTS

	PAGE
Armstrong Manufacturing Co.	4
Automatic Coil Winder Co., Ltd.	1
Belling & Lee, Ltd.	7
Birmingham Radiomart G5N1	6
British Institute of Engineering Technology	Back Cover
British McMurdo Silver Company, Ltd.	5
British Rola, Ltd.	3
British Thomson-Houston Co., Ltd., The	5
Dixon, Leslie	6
Electradix Radios	2
Galpins Electrical Stores	3
Goodmans Industries, Ltd.	6
Henley's, W. T., Telegraph Works Co., Ltd.	7
Institute of Wireless Technology	5
London Radio Supply Co.	8
McClure, John	5
Pamphonic Reproducers, Ltd.	5
Peto-Scott, Ltd.	5
Premier Supply Stores	6
Rothermel, R. A., & Co., Ltd.	6
Salford Electrical Instruments, Ltd. ... Inside Front Cover	
Savage, W. Bryan, Ltd.	6
Sound Sales, Ltd.	7
Summers, John, & Sons	3
Voigt Patents, Ltd.	2

RADIO LABORATORY HANDBOOK

By M. G. SCROGGIE, B.Sc., A.M.I.E.E.

Issued in conjunction with "The Wireless World"

"Radio Laboratory Handbook" gives the serious wireless worker complete information from first-hand experience about laboratory equipment, the instruments which are necessary and the correct methods of operating them.

The fundamental principles are fully discussed, as well as the sources of power and signals, instruments and measurements. Ultra-high-frequency work, the working out of results, and reference data are also dealt with. There is a collection of the most useful symbols, abbreviations, formulæ, laws, curves, tables and other data.

A complete index, numbered sections and cross references enable the reader to find what is required without loss of time.

384 pp. 214 illustrations

PRICE 8/6 NET By Post 9/-

From Bookstalls and Booksellers or direct from the Publishers

ILIFFE & SONS LTD.,
DORSET HOUSE, STAMFORD ST., LONDON, S.E.1

YOU WILL ENJOY "POP"

POP . . . Silence is Copper

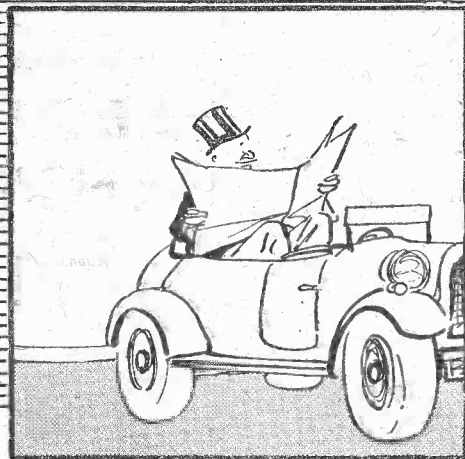
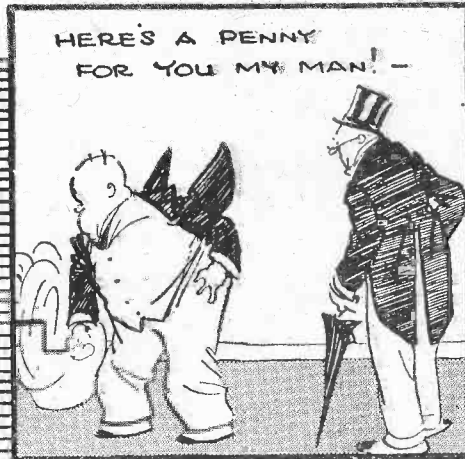
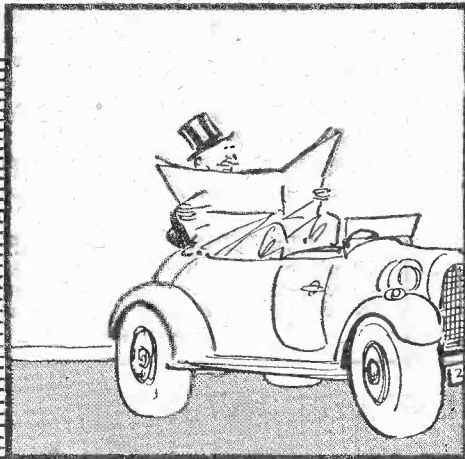

There is no doubt whatsoever that "Pop" of the DAILY SKETCH is consistently the funniest and most entertaining cartoon character in daily journalism. Have a laugh every morning.

Read him in the

DAILY SKETCH

All the News and Pictures Fit to Print

For discriminating World Listeners...

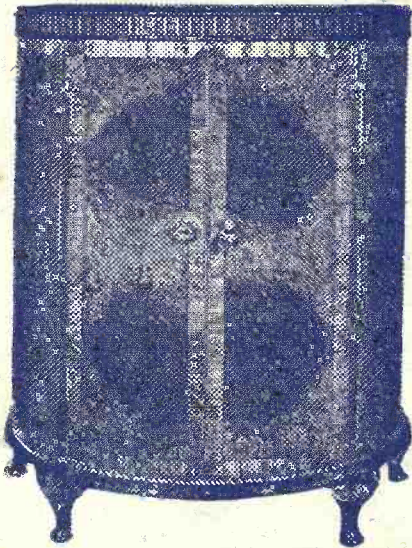

The Georgic Auto Radiogram

RADIO is a generic term: McMurdo Silver is the specific for the very best that radio has to offer.

Consider its appearance. Rich woods fashioned with a craftsman's patient skill to domicile utility in an abode of beauty. Consider its performance. If you desire to have the wide world at your finger tips, if you like to keep abreast of the world's news and views, if you **MUST** have a standard of reproduction that can only be described as reality itself, then McMurdo Silver is your instrument. Incidentally, it is the **ONLY** instrument through which distant American and other stations can be enjoyed with that full evenness and clarity which marks the dividing line between entertainment and annoyance.

We invite you to a demonstration so that you may **HEAR** for yourself how voices can come half across the world and still retain every inflection, every personal idiosyncrasy, and how music comes to you without one jot of addition or subtraction. It is a fascinating experience. We have also a very interesting catalogue, describing the full range of cabinet instruments, which will gladly be sent on request.

FOR THE TECHNICALLY MINDED

A 15-valve all-wave, superhet ● Six wavebands covering from 5 m. to 2,000 metres ● Twelve watts push-pull output into a McMurdo "Giant" high-fidelity speaker ● Very low noise mixing stage ● Variable sensitivity ● Separate electron coupled triode oscillator ● Inter-station noise suppression ● New tri-band I.F. amplifier using two stages ● I.F. amplification with six tuned circuits, giving three ranges selectivity, 3 k/c., 9 k/c.,

16 k/c. ● Triode first L.F. amplifier ● Phase splitter ● Dial calibrated in metres, megacycles and station names ● High-speed multiple A.V.C. system ● C.W. beat oscillator ● Bass and treble controls—over six feet of secondary band spread dial ● Standard model 200/250 volts A.C., 50 cycles. Export model 100/250 volts A.C., 40/100 cycles, sealed chassis, especially impregnated for tropics.

RADIOLYMPIA STAND 107 NATIONAL HALL



Quality to the Nth Degree

McMurdo Silver

BRITISH McMURDO SILVER COMPANY, LTD.
17, HERTFORD STREET, PARK LANE, W.1
Telephone: Grosvenor 2776

Available from high-class piano and radio dealers throughout the British Isles. Agencies in Australia, America, France and Switzerland

The ELECTRICAL REVIEW

The Complete Technical Journal

Practical articles on all aspects of electricity supply and utilisation—industrial, commercial and domestic. Latest news of the electrical industry and developments. Advertisement pages form a comprehensive buyers' guide.

Contents of August 18th issue

ELECTRIC MOTOR PERFORMANCE

The second article in a series dealing with current practice in electric motor design and applications.

NEW HIGH-VOLTAGE FUSES

Descriptive details and results of tests.

MAKING DOMESTIC APPLIANCES

Production methods at a new Leatherhead factory.

ELECTRICITY AT NEWPORT

How the progressive policy of the local supply undertaking has enabled the use of electricity to be extended despite a slump in industrial consumption.

EVERY FRIDAY 6d. Subscriptions: United Kingdom £1 14 8.
Canada £1 12 6. Other Countries
£2 1 6 per annum, post free.

ELECTRICAL REVIEW LTD.

Dorset House, Stamford Street, London, S.E.1

THIRD Edition of

The Autocar

GUIDE for the L DRIVER

is now available

Explains in simple language, with clearly designed diagrams and illustrations, precisely what the beginner must be able to do in order to pass as a fully qualified driver.

1/- net By post 1/2

From Booksellers and Bookstalls or direct from the Publishers:

ILIFFE & SONS LTD.,
DORSET HOUSE, STAMFORD STREET, LONDON, S.E.1

SHOW REPORT

The

Wireless World

6^D

THE PRACTICAL

RADIO & TELEVISION JOURNAL

Thursday, August 24th, 1939.

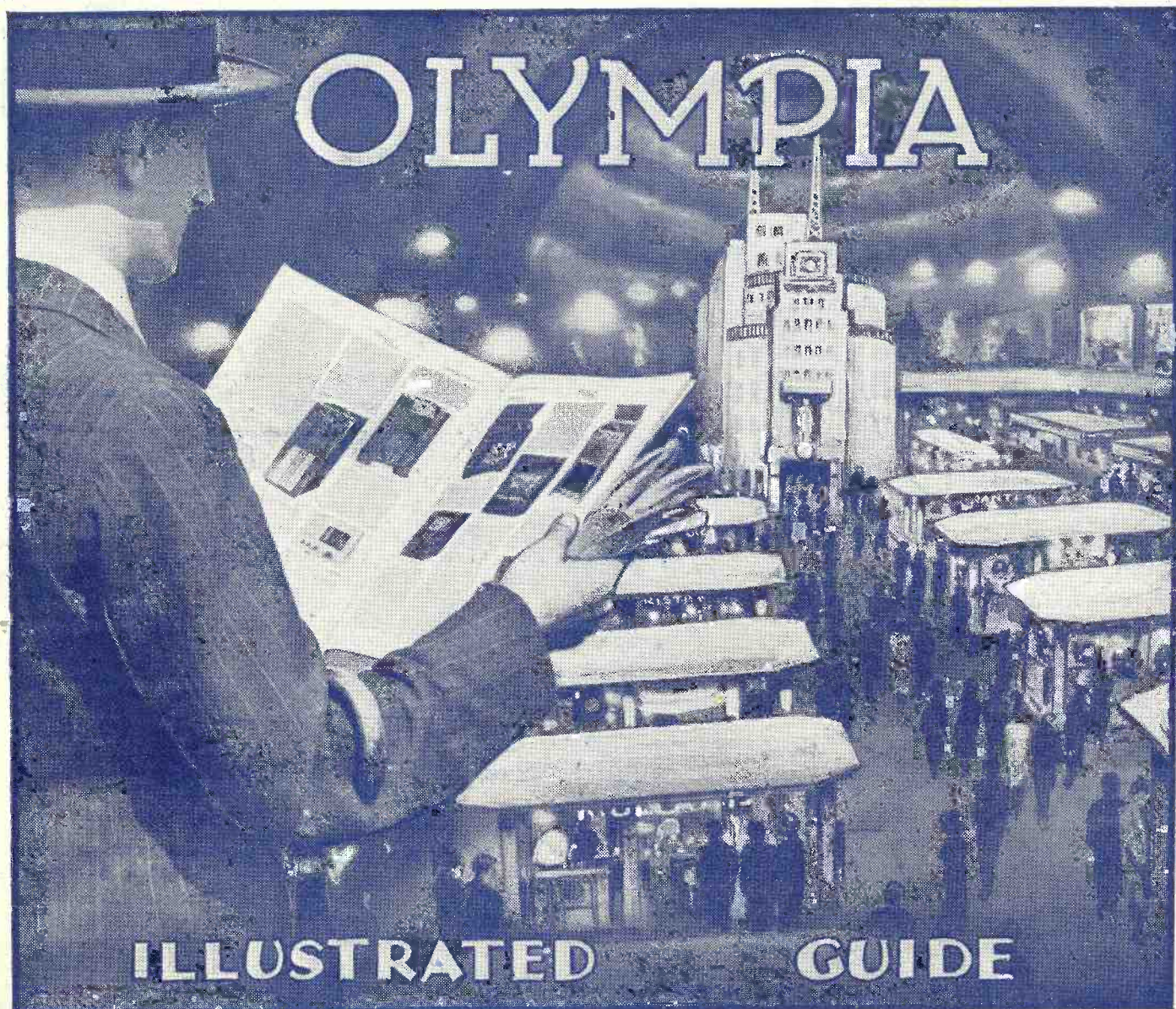

ILLUSTRATED GUIDE

WHATEVER CONDENSERS YOU NEED

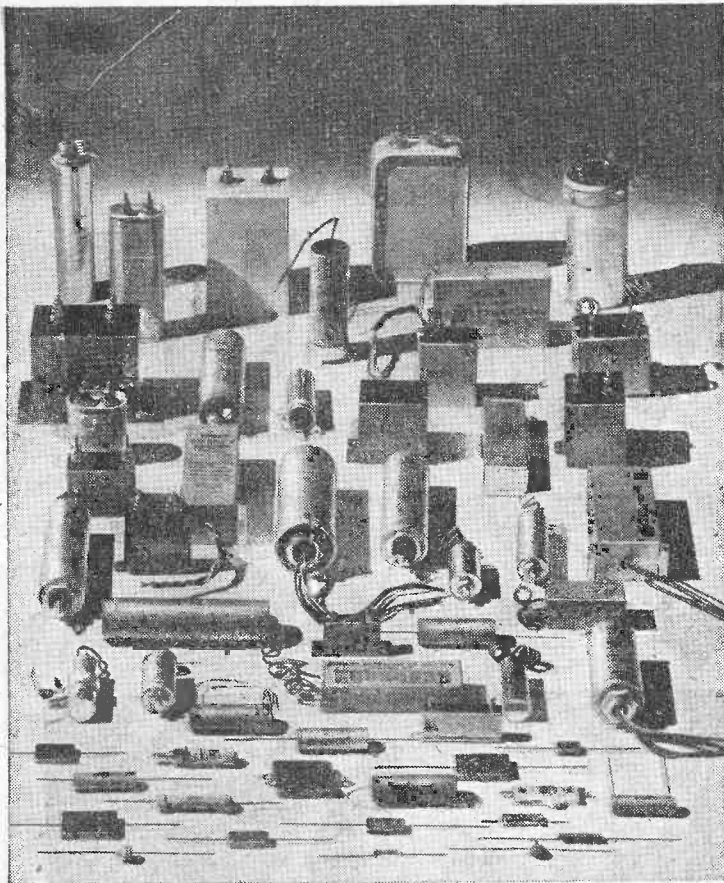

If you need condensers, if you don't need them; if you want to discuss them, or if your one desire is to forget them—we'll still be very pleased to see you again at Stand No. 28.

STAND 28 GRAND HALL

Mica Condensers	Electrolytic Condensers
Metallised Mica Condensers	Surge Proof Condensers
Ceramic Condensers	Drilitic Condensers
Paper Condensers	Radio Interference Suppressors

DUBILIER

DUBILIER CONDENSER CO. (1925) LTD., DUCON WORKS, VICTORIA ROAD, NORTH ACTON, LONDON, W.3.

Stand
30



You must visit Stand 30 and inspect the latest range of Westinghouse Metal Rectifiers and Westectors, but, if you are unable to visit the Radio Show, make sure you send 3d. in stamps to Dept. WW., for a copy of the latest edition of "The All Metal Way."

Westinghouse

METAL
RECTIFIERS

WESTINGHOUSE BRAKE & SIGNAL CO. LTD., 82, York Way, King's Cross, London, N.1.

Mention of "The Wireless World," when writing to advertisers, will ensure prompt attention.

PRECISION METERS

that Master every Testing Problem

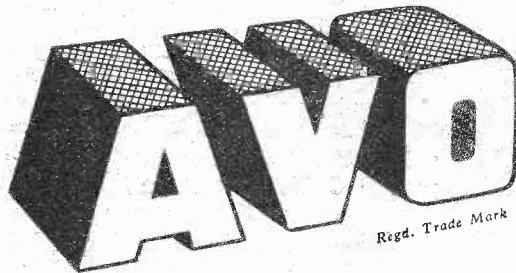
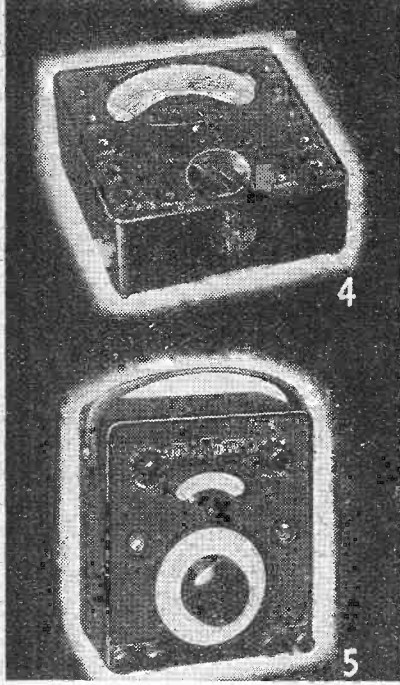
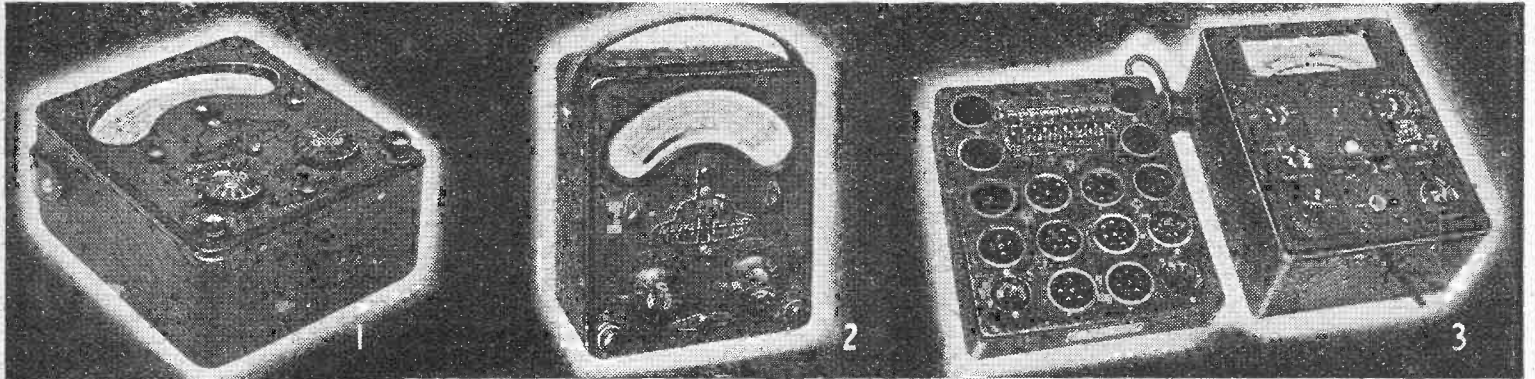

ELECTRICAL MEASURING INSTRUMENTS

BRITISH MADE

The Meters that Matter

1. Model 7 UNIVERSAL AVOMETER

A 46-range self-contained combination A.C./D.C. meter. Direct readings of A.C./D.C. amperes and volts; resistance; capacity; audio-frequency power output and decibels. B.S. 1st grade accuracy. **16 Gns.**

2. Model 40 UNIVERSAL AVOMETER

A 40-range self-contained combination A.C./D.C. meter, providing direct readings of A.C./D.C. amperes and volts; also resistance. B.S. 1st grade accuracy. (Supersedes the 36-range Universal Avometer.) **14 Gns.**

3. 'AVO' VALVE TESTER

Indicates mutual conductance direct in mA/v. ONE panel for all standard English, Continental and American valves. Any electrode combination can be set up for any valve base in the tester. Tests include Cathode/Heater insulation; diode and rectifier emission; filament continuity and electrode "shorts."

Complete with Universal Panel **12 Gns.**
 Universal valve panel alone **3 Gns.**

4. UNIVERSAL AVOMINOR

A 22-range A.C./D.C. moving-coil precision meter providing direct reading of A.C. voltage; D.C. voltage; current and resistance. With leads, and interchangeable test prods and crocodile clips. **£5.10.0**

★ 5. 'AVO' TEST BRIDGE

A simple, self-contained 50-cycle measuring bridge of great accuracy. Six ranges cover direct measurement of all normal sizes of condensers and resistances. Includes power factor and leakage tests. Can also be used as a sensitive valve voltmeter, and for inductance measurement. **8 Gns.**

Write for comprehensive folder describing all 'AVO' instruments, and/or full technical details of any individual instrument in which you are particularly interested.

Sole Proprietors and Manufacturer:

THE AUTOMATIC COIL WINDER & ELECTRICAL EQUIPMENT CO., LTD.
 Winder House, Douglas Street, London, S.W.1.

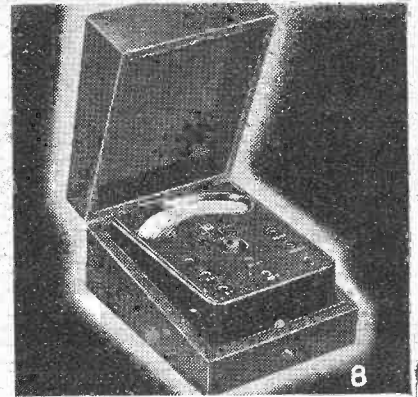

THREE new instruments have been added to the world-famous 'AVO' range—a new 40-range Universal Avometer*—a new Test Bridge*—and a new Low Resistance Ohmmeter (not illustrated). They embody all those finer points of design and construction which have made 'AVO' instruments the choice of all who demand precision testing.

6. 'AVO' CAPACITY METER

Provides VISUAL indication of capacity direct in micro-microfarads. Also indicates condenser losses. Employs resonance method at radio frequency. Six ranges, from 0 to 0.1 mfd., selected by rotary switch. **£23**

7. ALL-WAVE 'AVO' OSCILLATOR

Covers CONTINUOUS fundamental frequency band from 85 Kc. to 40 Mc. extended to 80 Mc. by harmonic calibration. Accuracy to within 1 per cent. External modulation, internal modulation or R.F. signal at will. Battery Model (incl. batteries), **9 Gns.** A.C. Mains Model, **10 Gns.**

8. D.C. AVOMINOR

A high-grade 13-range D.C. meter providing direct readings of voltage, current and resistance. In case, with leads, and interchangeable test prods and crocodile clips. **45/-**

OTHER 'AVO' INSTRUMENTS

22 Range D.C. AVOMETER	9 Gns.	'AVO' Low Resistance OHMMETER	42/-
High Resistance AVOMINOR	£3.10.0	The AVODAPTOR	27/-
		9-pin AVOCOUPLER	12/5

All 'Avo' Instruments available on Deferred Terms.

"RADIO INSTRUMENTS SIMPLIFIED"

This valuable text book gives practical information on the whole routine of testing present-day receivers. It deals fully with every prevalent source of trouble and clearly describes every test. An authoritative work of reference, it is acknowledged to be of great assistance to amateurs and service engineers alike. 150 pages, numerous diagrams and graphs. Price **2/6**. Post Free **2/10**.

GARRARD RECORD CHANGERS RADIO-GRAM UNITS MOTORS—SPRING & ELECTRIC

Convincing proof of their popularity is the world-wide demand for "GARRARD" equipment. Specialists in the design and manufacture of Record Changers... Radio-Gram. Units... Motors and Pick-ups... which have stood the test of time.



MODEL R.C. 50

REMARKABLE NEW MODELS

MIXED RECORD CHANGERS. An outstanding design, robust and reliable. Automatically selecting and playing 10in. and 12in. records in any combination.

- R.C. 50—AC Model for 100/130—200/250 volts 50/60 cycles **£8.0.0**
- R.C. 51—AC/DC Model for 100/130—200/250 volts DC and AC 25/60 cycles **£9.5.0**

POPULAR RECORD CHANGERS. A triumph of simplicity and ingenuity. The product of ceaseless research and experiment. A popular priced model, yet maintaining that high "GARRARD" standard—soundness of design and construction.

- R.C. 10—AC Model for 100/130—200/250 volts 50/60 cycles **£6.0.0**
- R.C. 11—AC/DC Model for 100/130—200/250 volts DC and AC 25/60 cycles **£7.5.0**

STAND No. 56—RADIOLYMPIA

"GARRARD" craftsmanship and precision engineering are reflected in every "GARRARD" Record Changer, Radio-Gram. Unit and Motor.

THE GARRARD ENGINEERING & MANUFACTURING Co. Ltd.
SWINDON • WILTS • ENGLAND

Do you want *quality* or just *noise*?

Distorted output is common to most P.A. Equipment sold at "attractive" prices, and distorted output is an abomination.

If you want P.A. Equipment, get the best. It costs a few pounds more than inferior equipment, but is cheapest in the long run. It gives complete satisfaction and pays bigger dividends.

Use

B.S.R. Public Address Equipment

High Fidelity as applied to sound reproduction means reproduction comparable with the original performance. It is not easy to obtain, but is guaranteed in all B.S.R. Equipment.

If you buy on price, don't expect high fidelity reproduction. If you want performance, use B.S.R. Equipment and be certain of it.

★ Borough and County Constabularies throughout the country use B.S.R. Police Patrol Car Loud Speaking Equipment.

Use



HETERODYNE OSCILLATORS

As used by leading electrical and radio manufacturing companies.

B.S.R. Equipment is Guaranteed.

BIRMINGHAM SOUND REPRODUCERS LTD.
CLAREMONT WORKS, OLD HILL, STAFFS. Grams: Electronic, Old Hill.
Phone: Cradley Heath 6212-3.

Holdens.



are

AT THE SHOW!

Varley designers and technicians will be available to discuss technical problems. Included in the full range of products shown will be the VARLEY DRY ACCUMULATOR.

STAND 108

Mention of "The Wireless World," when writing to advertisers, will ensure prompt attention.

R.G.D. present their 1939-40 programme

**COMPLETE R.G.D. RANGE
IN BRIEF**

Model 166. Six-valve table model, with permeability press-button tuning, operating on three wavebands. 10in. energised moving coil speaker unit gives level response from 70 to 7,000 cycles. Undistorted output, 5 watts 16 gns.
Universal model 18½ gns.

Model 196. Six-valve console with same specification as Model 166. A really delightful piece of furniture. The double-hinged lid opens like a cocktail cabinet to reveal all controls on a hand-high sloping panel 19½ gns.
Universal model 22 gns.

Model 296. Six-valve radiogramophone operating on three wavebands. Permeability push-button tuning on six stations. 10in. energised moving coil speaker unit gives level response from 60 to 7,000 cycles. Undistorted output, 5 watts. Non-automatic gramophone unit 29 gns.
Universal model 33 gns.

Model 356. Six-valve auto-radiogramophone—the same in every respect as Model 296 except that it has an automatic record-changer 35 gns.
Universal model 39 gns.

Model 3611. Eleven-valve console receiver operating on four wavebands. Motor-driven push-button control on eight stations. Automatic motor-driven wave changing. Motor-cruising. Speaker response, 60 to 7,500 cycles. Undistorted output, 6 watts. Cabinet with roll-type cover concealing controls 36 gns.

Model 5311. Eleven-valve auto-radiogramophone with radio specification as Model 3611. Automatic record-changer plays eight 10in. or 12in. records mixed. Piezo crystal pick-up. Walnut cabinet with ebonised sound louvres 53 gns.

Model 5511. Eleven-valve console operating on four wavebands. Motor-driven push-button control on eight stations. Automatic motor-driven wave changing. Motor-cruising. Speaker response, 50 to 8,500 cycles. Undistorted output, 12 watts. Cabinet with roll-type cover concealing controls 55 gns.
With remote control 60 gns.

Model 7511. Eleven-valve auto-radiogramophone with same radio specification as Model 5511. Automatic record-changer plays eight 10in. or 12in. records mixed. Piezo crystal pick-up 75 gns.
With remote control 80 gns.

Model 1015. 14-valve, 20-stage auto-radiogramophone operating on six wavebands—including television sound and 19-20 metres bandspread. Motor-driven push-button tuning and remote control on eight stations. Automatic motor-driven wave changing. Auto-changer plays eight 10in. or 12in. records mixed. Piezo crystal pick-up. Electric clock. Loudspeaker response, 40 to 8,500 cycles. Undistorted output, 18 watts 110 gns.

TELEVISION

Model 391. 22-valve vision and sound receiver. 9in. cathode ray tube gives directly-viewed picture, 7½in. by 6in. Magnetic focusing and scanning. Separate mains switches for sound and vision. Console cabinet with four controls only on front panel. 45 gns.
Also available with 12in. tube giving picture 10in. by 8in. 52 gns.

Model 391 R.G. 28-valve combined television receiver and auto-radiogramophone. 9in. cathode ray tube with magnetic focusing and scanning. Television controls and 7½in. by 6in. picture protected by folding panel at front of instrument. Radio controls and auto-changer mounted under lid 75 gns.

Model 392 R.G. 34-valve combined television receiver and auto-radiogramophone—gives indisputably the finest reproduction of sound and vision in the world to-day. 12in. cathode ray tube gives 10in. by 8in. picture indirectly viewed through mirror in lid. Completely independent television and radio. All controls mounted under lid. 130 gns.

EVERY year R.G.D. "makes news" with the most magnificent instrument in all Radiolympia. We believe we shall do it again this year. The R.G.D. auto radiogramophone at 110 guineas and the R.G.D. combined television receiver and auto-radiogramophone at 130 guineas are finer than anything we have ever built before. But this year we believe we shall hit the headlines in yet another way. Model 166—the wonderful new R.G.D. table receiver at 16 guineas—has already sold as fast as we can make it. In its class it is outstanding. Don't miss it when you visit us at Radiolympia.

RADIOLYMPIA, STAND 29

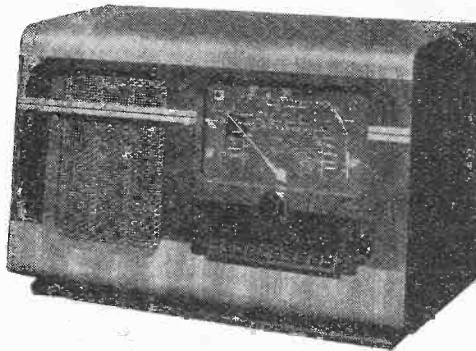
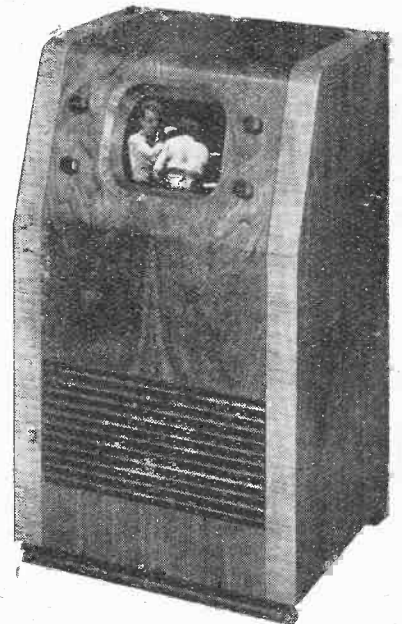

Table Model 166.
We count this instrument among our finest achievements. With its 10in. loudspeaker and acoustically-correct cabinet it approaches very near to the tonal perfection of the larger R.G.D. instruments. 16 gns.

TELEVISION. This is console Model 391 with 7½in. by 6in. picture on inclined panel. 45 gns.



Auto-radiogram, Model 356.
Here are all the R.G.D. luxuries at a lower price than ever before. Controls and dial are on inclined panel for easy reach and reading. Tuning is by hand or by push-button. Auto-changer takes eight records 35 gns.

R.G.D. the aristocrat of radio

RADIO GRAMOPHONE DEVELOPMENT CO., LTD., GLOBE WORKS, NEWTOWN ROW, BIRMINGHAM, 6

Mention of "The Wireless World," when writing to advertisers, will ensure prompt attention.

For discriminating World Listeners...

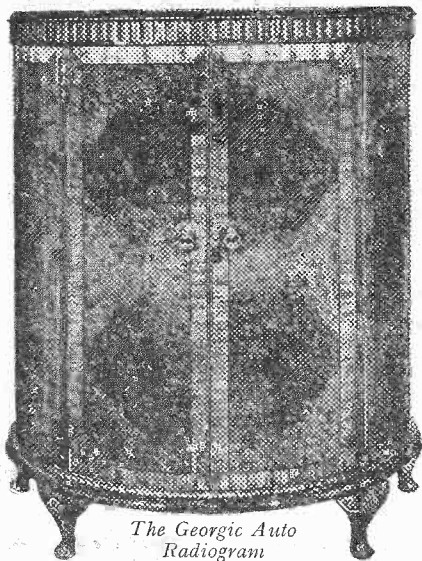

The Georgic Auto Radiogram

RADIO is a generic term: McMurdo Silver is the specific for the very best that radio has to offer.

Consider its appearance. Rich woods fashioned with a craftsman's patient skill to domicile utility in an abode of beauty. Consider its performance. If you desire to have the wide world at your finger tips, if you like to keep abreast of the world's news and views, if you **MUST** have a standard of reproduction that can only be described as reality itself, then McMurdo Silver is your instrument. Incidentally, it is the **ONLY** instrument through which distant American and other stations can be enjoyed with that full evenness and clarity which marks the dividing line between entertainment and annoyance.

We invite you to a demonstration so that you may **HEAR** for yourself how voices can come half across the world and still retain every inflection, every personal idiosyncrasy, and how music comes to you without one jot of addition or subtraction. It is a fascinating experience. We have also a very interesting catalogue, describing the full range of cabinet instruments, which will gladly be sent on request.

FOR THE TECHNICALLY MINDED

- A 15-valve all-wave, superhet
- Six wavebands covering from 5 m. to 2,000 metres
- Twelve watts push-pull output into a McMurdo "Giant" high-fidelity speaker
- Very low noise mixing stage
- Variable sensitivity
- Separate electron coupled triode oscillator
- Inter-station noise suppression
- New tri-band I.F. amplifier using two stages
- I.F. amplification with six tuned circuits, giving three ranges selectivity, 3 k/c., 9 k/c., 16 k/c.
- Triode first L.F. amplifier
- Phase splitter
- Dial calibrated in metres, megacycles and station names
- High-speed multiple A.V.C. system
- C.W. beat oscillator
- Bass and treble controls—over six feet of secondary band spread dial
- Standard model 200/250 volts A.C., 50 cycles.
- Export model 100/250 volts A.C., 40/100 cycles, sealed chassis, especially impregnated for tropics.

RADIOLYMPIA STAND 107 GRAND HALL ANNEXE

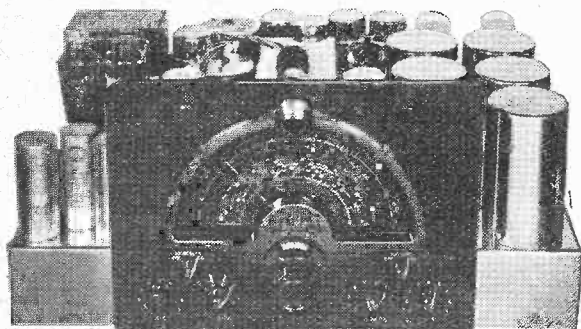

McMurdo Silver

BRITISH McMURDO SILVER COMPANY, LTD.
17, HERTFORD STREET, PARK LANE, W.1

Telephone: Grosvenor 2776

Available from high-class piano and radio dealers throughout the British Isles. Agencies in Australia, America, France and Switzerland

SHERLOCK HOLMES says...

"If it's electric test it with a PIFCO"



Don't waste time over testing electrical appliances. The Pifco Rotameter will do it for you, swiftly, surely, and with the minimum of trouble. Whether you're an amateur or an expert, it will enable you to trace faults immediately in radio sets, bells, or anything electrical. It is made from the finest of materials: designed for durability and absolute precision. **EIGHT RANGES:**

0-5 volts	0-10mA
0-20 volts	0-50mA
0-100 volts	0-250mA
0-400 volts	

Resist/valve test
Plug-in test for valves.

Complete in velvet-lined case with testing leads.

Your regular dealer can supply you, or write

PIFCO LTD.
Wafing St., Manchester.
London Address: 58, City Road, E.C.1.

PIFCO ALL-IN-ONE A.C./D.C. RADIOMETER

The only instrument of its kind in the world for making both A.C. and D.C. tests.

RANGES: 0-6 volts, 0-240 volts, 0-30 mA.

Filament and Resistance Test, and socket for plug-in test for valves. 8,000 ohms resistance. Complete with two 15-inch flex cables. Fitted with PIFCO DRY CELL.

12/6

PIFCO ROTAMETERS and RADIOMETERS

PIFCO ON THE SPOT WILL TRACE YOUR TROUBLES LIKE A SHOT

THIRD Edition of

The Autocar

GUIDE for the DRIVER

is now available

Explains in simple language, with clearly designed diagrams and illustrations, precisely what the beginner must be able to do in order to pass as a fully qualified driver.

1/- net By post 1/2

From Booksellers and Bookstalls or direct from the Publishers:

ILIFFE & SONS LTD.,
DORSET HOUSE, STAMFORD STREET, LONDON, S.E.1

COSSOR Radio

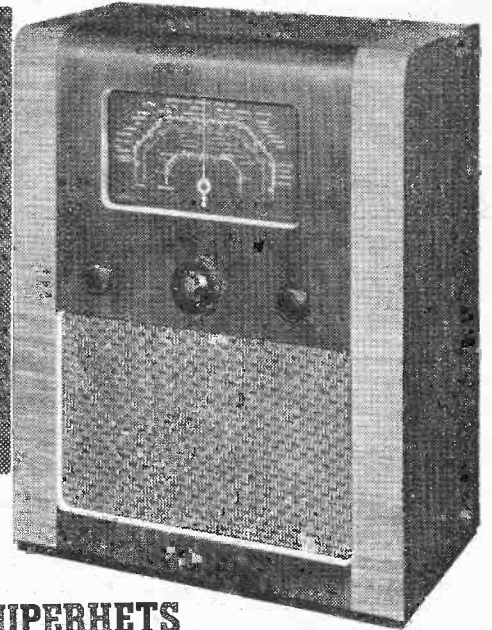

All-wave MAINS or BATTERY SUPERHETS

A.C. MAINS Model 71. Brilliant member of a family of four models presenting new ideas in superb all-world performance and utmost value. 5 Valves and 3 Wavebands. Single-knob slow-motion Tuning with edge-lit Dial. Highly sensitive 8" M.C. Speaker. Handsome cabinet as illus. Price **8½ GNS**

'UNIVERSAL' Model 46
With features for most efficient D.C./A.C. Mains performance. 5 Valves—3 Wavebands. Wide response P.M. Speaker. Walnut Cabinet, as shown. Price **9 GNS**



BATTERY Model 31
4 Valves and 3 Wavebands. Outstanding world-wide performance. With special features for economy operation. Wide-response 8" Speaker provides fine reproduction. Cabinet similar to illustration. Price, without batteries **7 GNS**

De Luxe Model 32
As Model 31, with luxury features. Special 8" Speaker of high flux density. Highly polished Walnut Cabinet. Price, without batteries, **8 GNS**

de luxe ALL-WAVE 6-V. A.C. MAINS Model 73

A superhet with superb technical features, including High Gain H.F. Stage on all wavebands, a new A.V.C. Circuit and "Magic Eye" Visual Tuning. Slow-motion Control with edge-lit Dial. 10" Concert Grand M.C. Speaker. Price **12½ GNS**

Year by year Coscor maintains a leading position in current radio development. Steadily the Coscor Research Laboratories—the largest in the industry—originate features which are rapidly adopted in standard practice. Peak of this consistent achievement is the range of Coscor Receivers at Radiolympia—one of the finest exhibits there of quality, reliability and value. Write for a copy of the illustrated Catalogue of Coscor Radio—"Radiolympia Edition," or see the complete range on

**STAND No. 48
Radiolympia**

ALL-WAVE 5-VALVE SUPERHET CONSOLE

Model 62. Brings in station after station with great ease due to an advanced circuit design, giving outstanding performance with extreme range and selectivity. With 5 Valves, 3 Wavebands, single-knob slow-motion Tuning. Beautifully designed and finished Walnut Cabinet built on acoustic principles doing full justice to the rich natural tone of the 8" M.C. Speaker. Price **11 GNS**

Prices do not apply in Eire.

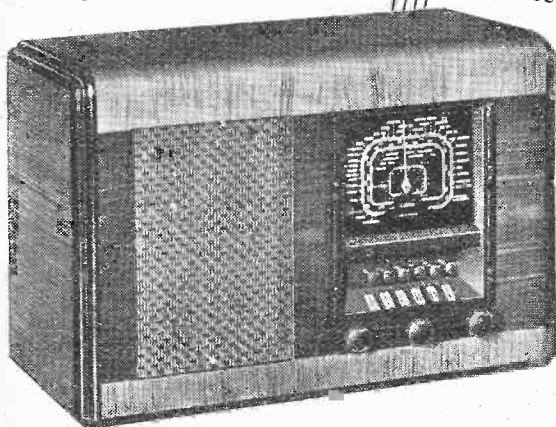

COSSOR 'Press-Button' SUPERHETS

Battery Model 33

Similar to illustration. 4 Valves—3 Wavebands. 6 Buttons, re-set from front. Separate Tuning, and full-vision Dial. 8" M.C. Speaker of high flux density. Economy battery consumption. Price, without batteries - **9 GNS**

A.C. Mains Model 81

As illustrated. 5 Valves—3 Wavebands. 6 Buttons, re-set from front. Separate slow-motion Tuning with edge-lit Dial. Tone Control. Full A.V.C. 8" M.C. Speaker. Handsome Cabinet. Price **10½ GNS**

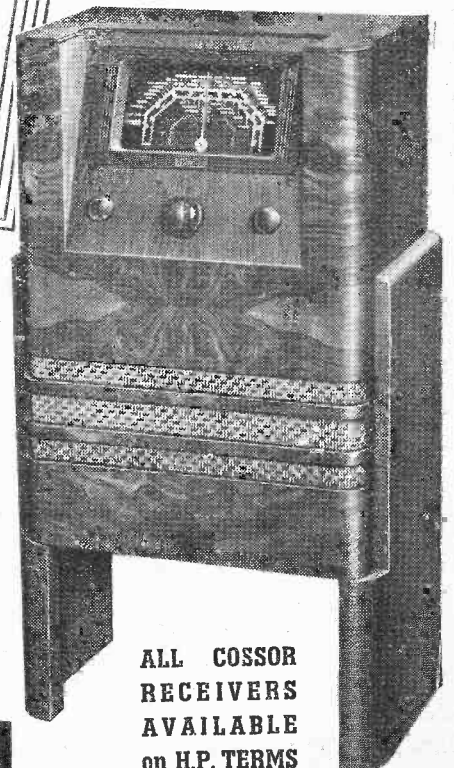

**ALL COSSOR
RECEIVERS
AVAILABLE
on H.P. TERMS**

A.C. COSSOR LTD · HIGHBURY GROVE · LONDON · N · 5

Belling-Lee announce

NEW SKYROD & TELEVISION AERIALS... NEW COMPONENT PRICES ETC. ETC.

'SKYROD' AERIALS

REGD. TRADE MARK

The new 'SKYROD' resonating vertical aerial, together with all-metal mast, is in 6ft. sections for easy assembly. Only one lashing is required, and a new type of aerial transformer designed as a bridge is plugged in by means of a watertight coupling. The table below shows the various assemblies available.

LIST NO.	12-ft. Skyrod.	12-ft. Mast.	6-ft. Extra.	Chimney Lashing.	Clamps for Customer's Pole.	Eliminoise and Cable.	PRICE		
							£	s.	d.
524 LK	■	■		■		■	5	15	0
518 CK	■		■		■	■	4	15	0
524 L	■	■		■			3	0	0
512 L	■			■			2	0	0
512 C	■				■		1	5	0

TELEVISION AERIALS

The new Belling-Lee all-metal Television Aerials feature a new type moulded insulator enclosing terminal connections and with extra long path to prevent picture variation with rain, snow and frost. The whole construction is more robust, and the steel tubes are insulated and rubber capped. Lightning arrestor built in. The table below shows the various assemblies available, feeder kits extra.

LIST NO.	Di-pole with built-in Lightning Arrestor	Reflector	12-ft. Mast	Chimney Lashing	Short Stand-off Arm	Long Stand-off Arm	Brickwork Mounting	For Mounting on Customer's mast	Eliminoise and 75 ft. Cable	PRICE		
										£	s.	d.
502 L	■	■	■	■						4	7	6
502 W	■	■				■	■			2	10	0
502 C	■	■						■		2	2	0
501 L	■			■		■				1	12	6
501 T	■					■	■			1	5	0
501 W	■						■			1	0	0
503 C*	■	■						■	■	5	5	0
503 L*	■	■	■	■					■	7	10	6

* Combined Television and Skyrod Aerial for use when separate aerial and earth terminals are correctly provided for medium and long wave reception.

FEEDER KITS (in cartons, with 75 feet cable). 336K Balanced Feeder with extra lightning arrestor (built-in arrestor operates only with coaxial cable); Suffix B, 17/6. 388K Solid coaxial; Suffix S, 25/-. 389K Air-spaced coaxial; Suffix A, 50/-. When ordering cable with aerial, merely add appropriate suffix to aerial list number.

Full particulars of all Belling-Lee Aerials and Components on request. Prices do not apply to Eire. "SKYROD" and "ELIMINOISE" are registered trade marks of Belling & Lee Ltd.

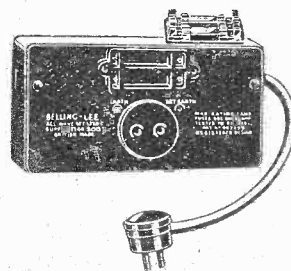

300 MAINS FILTER

Ensuring that no conducted interference passes from mains to receiver. Particularly useful for flats, etc. Complete with fuses, plug, etc. 29/6.

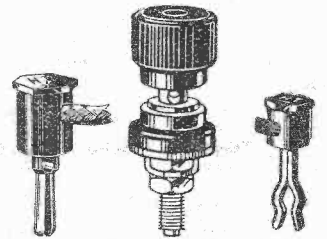

TERMINALS, SPADES, & WANDERPLUGS

"B" Type Terminal, 15 amp., No. 1001, 10d. "R" Type Terminal, 7 amp., No. 1003, 4½d. Spade Terminal, black or red, No. 1275, 1½d. Bow Spring wanderplug, 12 indications, No. 3415 or 1/B, 1½d.

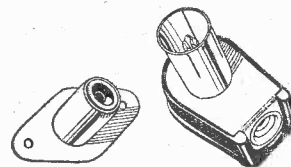

COAXIAL PLUG & SOCKET

To take and grip air-spaced or solid dielectric cables for mounting on chassis or cover of conduit box. Metal parts silver-plated. No. 373A (air-spaced) and 373S (solid), 3/6. In Conduit Box (suffix B), 6/6.

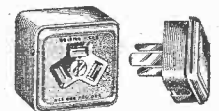

FLAT PIN PLUG & SOCKET

For radio circuits up to 50 watts, also standardised for balanced television feeders. Prevents Loudspeaker, etc., being plugged into mains. Flush or surface mounting. Side flex entry. In brown bakelite. Plug only, 303P, 1/-; Flush socket, 303F, 1/9. Surface socket, 303S, 1/9. Cream bakelite extra.

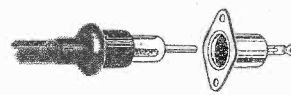

R.M.A. COAXIAL PLUG AND SOCKET

An improved and less expensive coaxial plug and socket to R.M.A. specifications. End loading with soldered conductors for sure connection. Complete with moulded rubber handle. No. 507R Plug, Price 6d. No. 507C Socket, Price 6d.

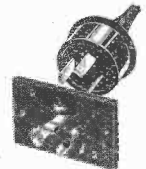

R.M.A. 3-PIN PLUG AND SOCKET

A modification of the Belling-Lee three flat pin plug and socket. Made to R.M.A. specifications with moulded rubber plug. End loading. Specially made for radio circuits as there is no danger of plugging into mains. No. 303R Plug, Price 9d. No. 303C Socket, Price 6d.



COAXIAL & SCREENED CABLE

H.F. Balanced twin feeder, 336, 6d. yd. Solid coaxial with additional "Telconax" covering, L388c, 9d. yd. Air-spaced coaxial, "Telconax" insulated and outer covering, L389, 1/9 yd. "Eliminoise" screened cable, with "Telconax" low loss insulation, L1221, 1/- yd.

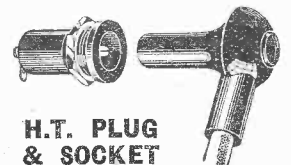

H.T. PLUG & SOCKET

Both parts moulded bakelite. Suitable for Television, etc. Designed for 6,000 volts. No. 353, 4/9.

BELLING & LEE, LTD., CAMBRIDGE ARTERIAL ROAD, ENFIELD, MIDD.

The Wireless World

THE
PRACTICAL RADIO
JOURNAL
29th Year of Publication

No. 1043.

THURSDAY, AUGUST 24TH, 1939

VOL. XLV. No 8

Proprietors : ILIFFE & SONS LTD.

Editor :
HUGH S. POCOCK.

Editorial,
Advertising and Publishing Offices :
DORSET HOUSE, STAMFORD STREET,
LONDON, S.E.1.

Telephone : Waterloo 3333 (50 lines).
Telegrams : "Ethaworld, Sedist, London."

COVENTRY : 8-10, Corporation Street.
Telegrams : Telephone :
"Autocar, Coventry." 5270 Coventry.

BIRMINGHAM :

Guildhall Buildings, Navigation Street, 2.
Telegrams : Telephone :
"Autopress, Birmingham." 2971 Midland (5 lines).

MANCHESTER : 260, Deansgate, 3.
Telegrams : Telephone :
"Iliffe, Manchester." Blackfriars 4412 (4 lines).

GLASGOW : 26B, Renfield Street, C.2.
Telegrams : "Iliffe, Glasgow." Telephone : Central 4857.

PUBLISHED WEEKLY. ENTERED AS SECOND
CLASS MATTER AT NEW YORK, N.Y.

Subscription Rates :

Home and Canada, £1 10s. 4d. ; other
countries, £1 12s. 6d. per annum.

As many of the circuits and apparatus described in these
pages are covered by patents, readers are advised, before
making use of them, to satisfy themselves that they would
not be infringing patents.

CONTENTS

	Page
Editorial Comment	163
Yacht DF Set	164
Problem Corner	167
High-voltage Problems—III : HT Transformer Construction ..	168
News from the Clubs	170
Olympia, 1939 : Stand-to-Stand Report	171
Letters to the Editor	183
"The Wireless World" Pre-Set Quality Receiver (continued)	184
News of the Week	187
Simplifying Television Controls ..	189
Random Radiations	190
Television Programmes	191
Exhibitors at Olympia	192
Unbiased	194

EDITORIAL COMMENT

The Show

Something for Everybody

BY the time that this number of *The Wireless World* appears, the National Radio Exhibition, 1939, will be in full swing. From the point of view of the majority of our readers, it seems likely to prove the most interesting Show that we have had for many years, and it will indeed be surprising if the organisers have reason to regret their decision to widen its appeal.

It has now been realised that, so far as the industry is concerned, the object of an annual Show is not to "sell broadcasting," whatever it may have been in the past. We need look no farther than the licence figures to find that the idea of broadcasting in itself no longer needs any tempting lures ; in fact, the public has already swallowed it, hook, line and sinker. When we delve a little more deeply into figures and statistics, it becomes clear that the real purpose of an exhibition nowadays is to sell better broadcast receivers, rather than broadcasting itself. It has been proved—if indeed proof were needed—that a very large percentage of the sets at present in use are long overdue for renewal. Thus it becomes the proper function of the Show to inculcate in the mind of the visitor discontent with his present receiver, and a consequent desire to possess something better. But this object cannot be achieved with any great measure of success unless the listener takes some interest in the design of his set ; among the most welcome features of the present Show are those which encourage him to do so.

These basic principles, of which the truth cannot seriously be questioned, have clearly been taken into account by

those responsible for the organisation of Radiolympia, and it is to be hoped that they will be constantly borne in mind by all taking part in it during the currency of the Show. Further, every effort should be made to study public reactions to features that are new this year, in order that still better shows may be planned for the future. The broadcast receiver of to-day is so complex that it is by no means easy to encourage the man in the street to take an intelligent interest in its functioning. But this is a difficulty that must be overcome if a healthy market in replacement receivers is to be created, and enough has already been done to show that the difficulty is not insuperable. Incidentally, perhaps the best example of how to cultivate the desired interest was afforded by one of the preliminaries to the Show. We refer to the excellent broadcast talk "The Ordinary Listener and his Set" given in the National programme last week by Mr. R. A. Watson Watt.

Emphasis on the export market is another new feature of Olympia that is particularly welcome. Too long has it been a reproach that Empire broadcasting is, more often than not, received in the British Dominions and Crown Colonies through the intermediary of foreign sets. *The Wireless World*, which first brought forward the idea of Empire broadcasting, naturally feels strongly on this matter, and it is gratifying to record that a considerable number of manufacturers have gone to the trouble of producing oversea models.

It has been suggested that the greater prominence now being given at the Show to the technical aspects of wireless may have an adverse effect on attendance. That we refuse to believe ; visitors whose chief interest lies in the programme side of broadcasting are at least as well catered for as hitherto.

Yacht DF Set

LONG-WAVE RECEIVER FOR WEATHER FORECASTS AND POSITION FINDING

By F. L. DEVEREUX, B.Sc.

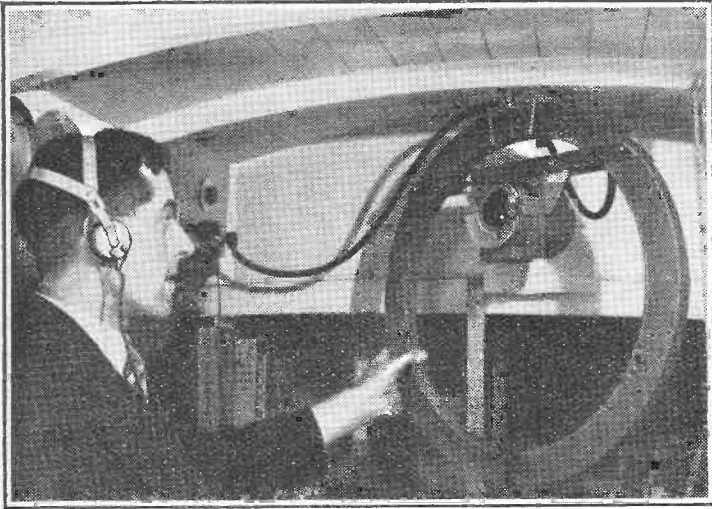

THE increasing interest in sailing and cruising as a recreation and sport has resulted in a number of inquiries from readers for a simple, but

accurate direction finder for small boats. The design given in this article represents what may be regarded as a minimum specification for the accuracy required by the amateur navigator.

THE owner of a small sea-going yacht with a waterline length of 30ft. or less cannot find space for the elaborate direction-finding equipment marketed by the leading wireless communication companies for use in trawlers and steam yachts. He can, of course, make do with a standard battery portable, but such sets do not always give a sharp minimum and the frame aerial is neither of the right proportions nor wound with the precision required for taking accurate bearings.

While not aspiring to the fractional degree accuracy of the more expensive installations, the set to be described will give results well within the errors of other observations made as a matter of routine by the amateur navigator. Attention has been given to the question of space and stowage, and for this reason it has been divided into three units which can be stowed in any of the odd corners to be found in every yacht's accommodation.

As the receiver is intended primarily as an aid to navigation, it has been confined to the long-wave range. At sea the need

for light entertainment is not so pressing, and for a wet afternoon in harbour sufficient variety of programme material can generally be found among the long-wave stations. All transmissions of direct interest to the yachtsman—weather bulletins from the B.B.C. and Borough Hill, and the coastal wireless beacon stations, are all to be found on the long-wave range.

The concentration on a single waveband offers several important advantages. There is no waverange switch to get out of order, and the saving of space on extra coils and screening cans makes for a compact unit; but most important of all, one is not tied down to broadcast coils of standard inductance and the circuits can be designed "from scratch" to suit the neces-

sarily high self-capacity of the screened frame aerial.

Total screening of the set, the frame aerial and the connecting leads is essential to ensure freedom from variations in tuning when handling the frame or from changes in capacity due to the motion of the vessel. It also helps to give a clear minimum when the frame is at right angles to the direction of the incoming wave. Absolute extinction of the signal at minimum is not obtained by complete screening alone, as the capacity to earth inside the screening is not symmetrical. A perfect balance can be obtained by using an intermediate centre tapped RF transformer arrangement, but its complication rules it out for a small boat. In practice it is easy to estimate the bearing by the time-honoured method of taking the mean of two positions giving equal signal strength on either side of the minimum.

A Large Frame

A comparatively large diameter frame is desirable, not only on account of its greater efficiency on long wavelengths but because its high ratio of diameter to winding width ensures greater geometrical accuracy in relation to the wavefront and also to the alignment of the compass.

In the writer's view a compass mounted on the frame aerial itself is absolutely essential. Many commercial DF sets have a fixed scale showing the bearing of the

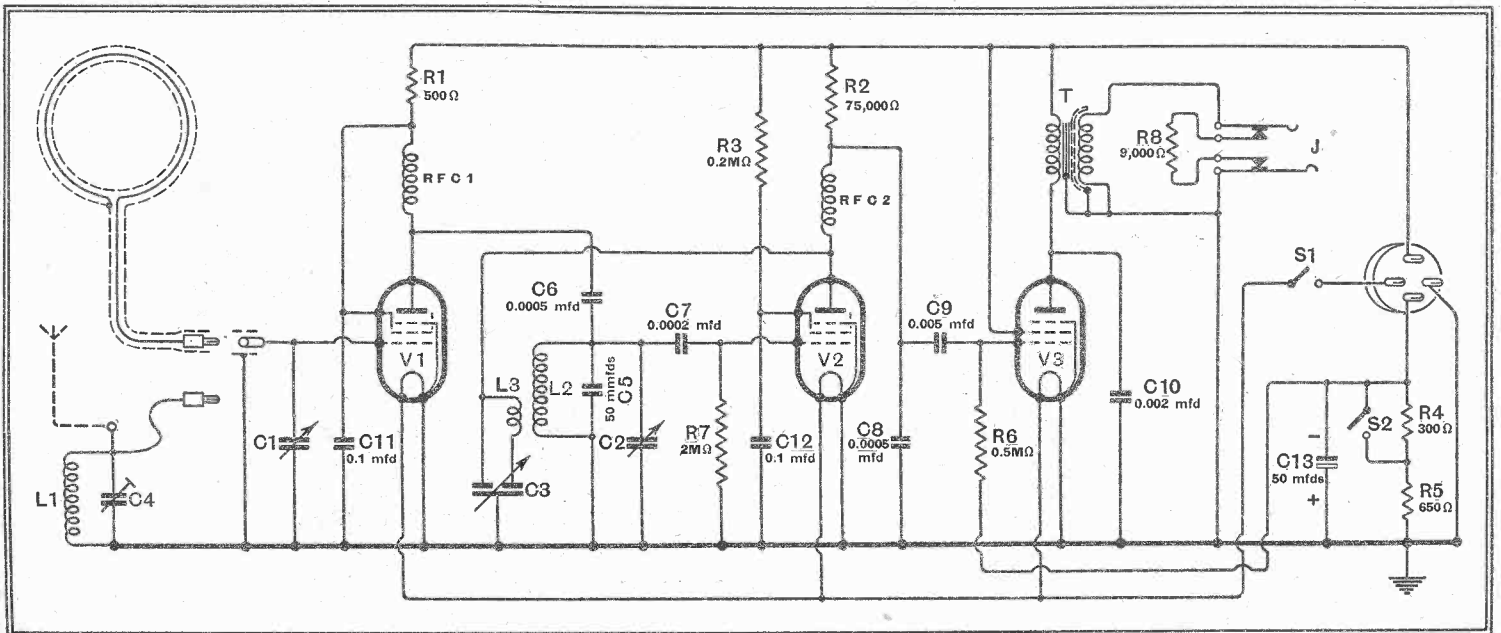

Circuit diagram showing values of components. The wiring should present no difficulty if this diagram is studied in conjunction with the photographs of the chassis.



frame in relation to the fore-and-aft line of the ship, and the helmsman has to note the course at the instant at which the bearing is taken in order that a subsequent correction may be made. Even with a trained crew this is difficult in a small boat which cannot be held to an absolutely straight course; single handed, it is practically impossible.

Another "big ship" practice which, in the writer's view, is wrong in sailing yachts is that of fixing the frame to rotate on a bearing passing through a gland in the deck or cabin top. This is all very well for a vessel which keeps, or at least averages, an even keel, but on a sailing vessel heeled over in a breeze the axis of the frame is no longer perpendicular to the wavefront of the signal, and a false bearing may result. It is much better to hang the frame from the inside of the cabin roof and allow it to find the vertical when bearings are being taken. When not in use it can easily be given a temporary lashing to prevent it from swinging.

Like most things in small boats, the frame aerial will occasionally come in for some hard knocks, and it is for this reason that the obvious methods of screening the frame in metal tubes or channel sections were avoided. An all-metal structure is liable to per-

Views showing layout of components above and below the chassis shelf. Each part is lettered to correspond with the circuit diagram, and the wiring is quite straightforward.

manent distortion as the result of a blow, and what is required is something tough and slightly resilient. Plywood covered by thin copper foil seemed a promising form of construction, and in practice has completely justified its choice.

To build the frame, two rings are first cut from 2ft. square sheets of $\frac{1}{4}$ in. plywood. A suitable cutter for this purpose is easily made by driving two nails through a piece of square-section wood at a distance apart equal to the required radius. One nail serves as a pivot and is inserted in a pilot hole previously drilled in the centre of the plywood sheet, while the other is filed up to a knife edge to act as a cutter. The plywood is then scribed round from both sides until it breaks through. The outer circle should be cut first in order to retain the centre for the inner circle.

The two rings are then joined together by sixteen hardwood blocks spaced at equal intervals. Each block has a saw-cut to accommodate the wire, which is wound "edge-on." A total of twenty-six turns of 22 SWG enamelled wire gives the inductance required. The ends are brought out through holes in one of the plywood rings and soldered to the screened connecting cable, one wire to the braiding and the other to the centre wire. To relieve the joints of mechanical strain, the cable is clamped down to the frame by a

small wood block, suitably hollowed out.

Finally, the whole frame, including the junction block, is covered with copper foil about 0.005in. thick, leaving a gap of $\frac{1}{16}$ or $\frac{3}{32}$ in. diametrically opposite to the point at which the screened lead is brought out. The foil is sold by most metal merchants in a roll about 6 inches wide, and from this segments may be cut to cover the flat sides of the frame and held down by copper tacks at each of the spacing blocks where the wood is thickest. It is hardly necessary to point out that the tacks must not be long enough to go through to the winding. The joints between the segments are soldered, and finally strips of foil just over 1 inch wide are soldered round the inside and outside of the frame, leaving a gap at the bottom to correspond with those in the side coverings. A binding of insulating tape will prevent the entrance of moisture at the gap, and the whole frame may be taped with advantage to prevent damage to the thin foil.

Compass Alignment

Choice of a compass is left to the reader. It should be of the dead-beat type and mounted so that the lubber line is perpendicular to the plane of the frame. The writer uses an ex-R.A.F. compass of the spherical type, which is available from

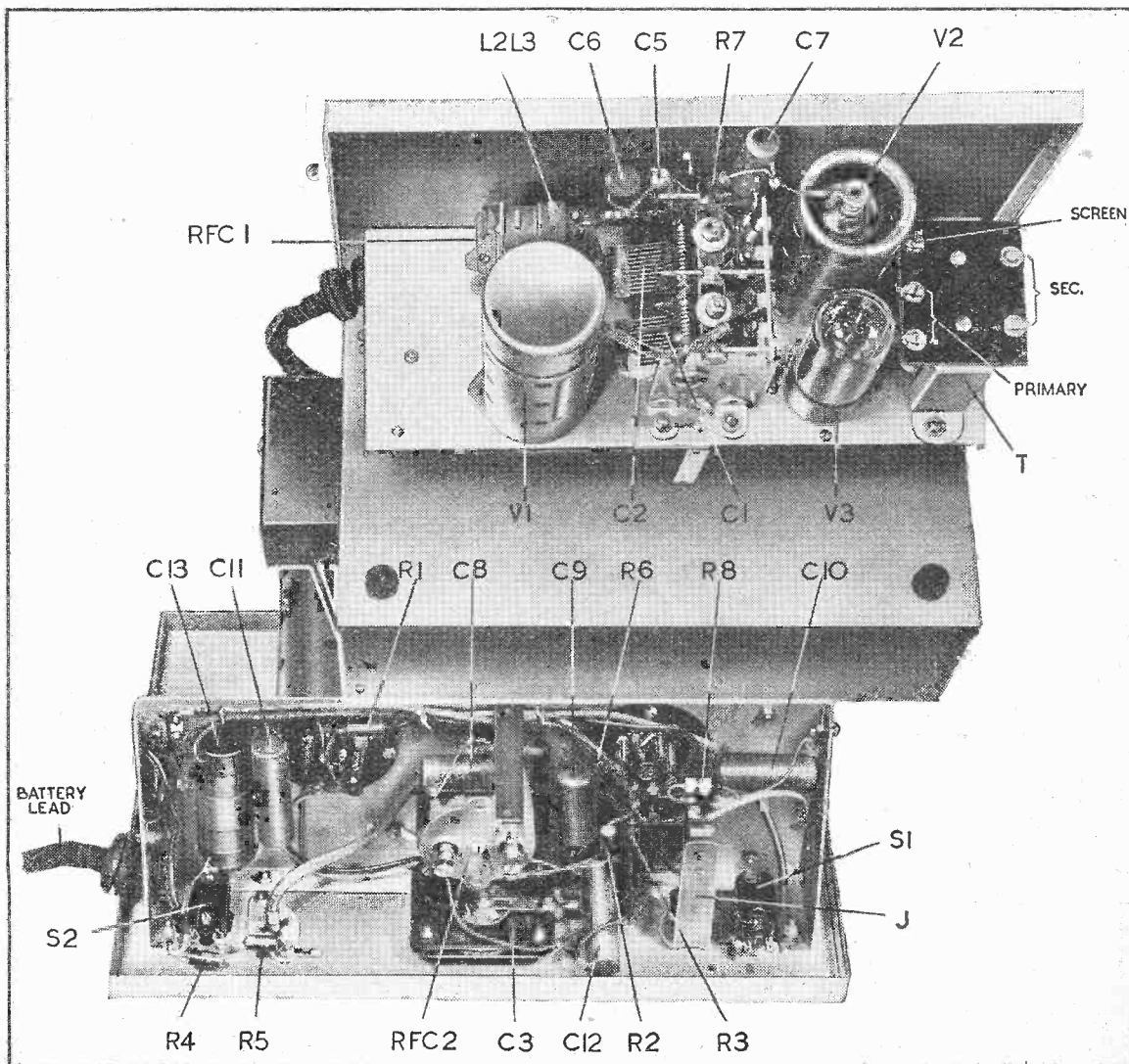

Yacht DF Set—

most dealers in Government disposal stores.

The screened connecting cable should be of a low-capacity type, as the self-capacity of the frame circuit is already

set tunes down to about 750 metres.

Three valves—RF, detector, and output—are sufficient for coastal cruising anywhere in Great Britain. When not using the frame aerial a "dummy" circuit complete with trimmer to simulate

the frame capacity will give equally good results from the point of view of signal strength when fed from an aerial 6ft. long tacked along the roof of the cabin.

The valves used are of the latest 1.4 volt type, and the set is run entirely from dry batteries, so that one is quite independent of charging stations. HT and LT are in the same block of cells, and connection is made through a standard four-pin valve plug.

Coils for the RF coupling and "dummy" aerial circuit are provided by the beat frequency oscillator

coils in the Wearite "P" series, the centre tap being ignored. The reaction coil L3 consists of 20 turns of 40 DSC wound over a layer of waxed paper insulation on the outside of L2.

To match the frame capacity an additional fixed capacity of 50 micro-mfd. is required across the tuned RF circuit. When ganging reduce the trimmer across section C1 of the variable condenser to minimum, and then add the required difference by means of the trimmer on C2.

The connections of the detector are straightforward, and it operates with "zero" bias to give smoothness of reaction. Tests showed that no real advantage in sensitivity was gained by using positive bias, and reaction was much less easy to control.

Bias for the output stage is derived from R4 and R5. When using phones —i.e., when direction finding — an economy in HT current can be effected by opening switch S2. This reduces the total consumption from 11 to 8 mA, and will ensure that the full life of the LT section

is used before the HT section runs out.

To prevent RF entering the set through the 'phone leads and thus affecting the "minimum" obtained on the frame, a special output transformer with an electrostatic screen between primary and secondary is necessary. A suitable transformer is made by Sound Sales, Ltd., Marlborough Road, London, N.19. Piezo-electric headphones, obtainable from R. A. Rothermel, Ltd., Rothermel House, Canterbury Road, Kilburn, London, N.W.6, are recommended on account of their non-magnetic properties—an important point when peering at the compass to take a close reading. The transformer ratio is 1:1, and if ordinary magnetic 'phones are used (and there is no reason why they should not, if one remembers not to get too near the compass) a resistance of 2,000 ohms will give approximately the right impedance at working frequencies. An artificial load is connected across the inside contacts of the

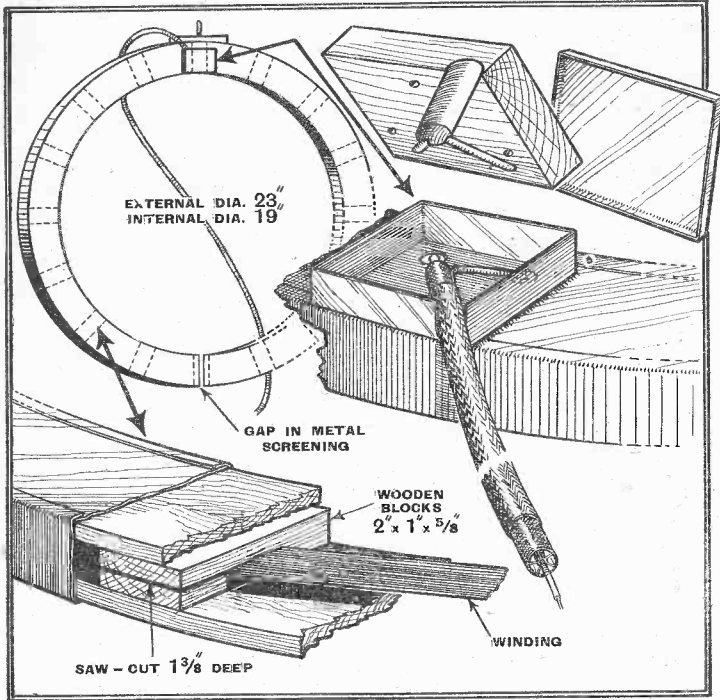

Leading dimensions and constructional details of the frame aerial. The winding consists of 26 turns of 22 SWG enamelled wire.

high. An inductance of 1,000 μ H was chosen as a basis for the RF circuits. This tunes to Droitwich with the condenser at maximum, so that if one is a bit late in switching on for the weather report the dial can be quickly turned round to maximum and no time is lost in finding the station. Another advantage is that, in spite of the restricted coverage resulting from the high minimum capacity, one makes sure of a minimum wavelength well below the wireless beacon stations. The majority of these lie between 900 and 1,050 metres, and the

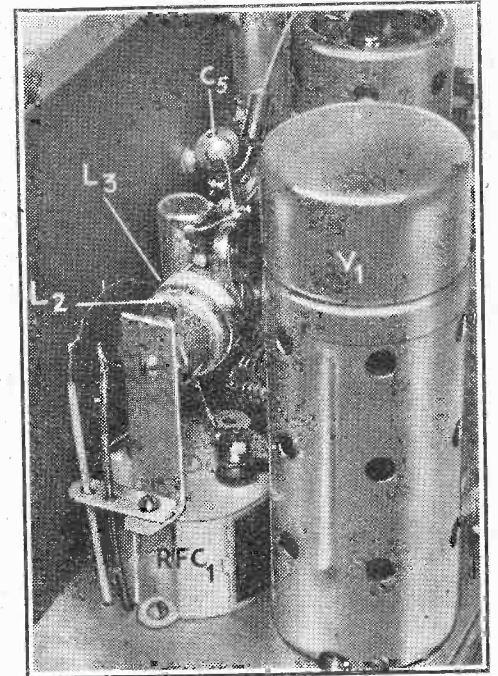

Details of RF coil mounting. The reaction coil connections are anchored to wires from the underside of the chassis and are easily reversed if the trial connections are made in the wrong sense.

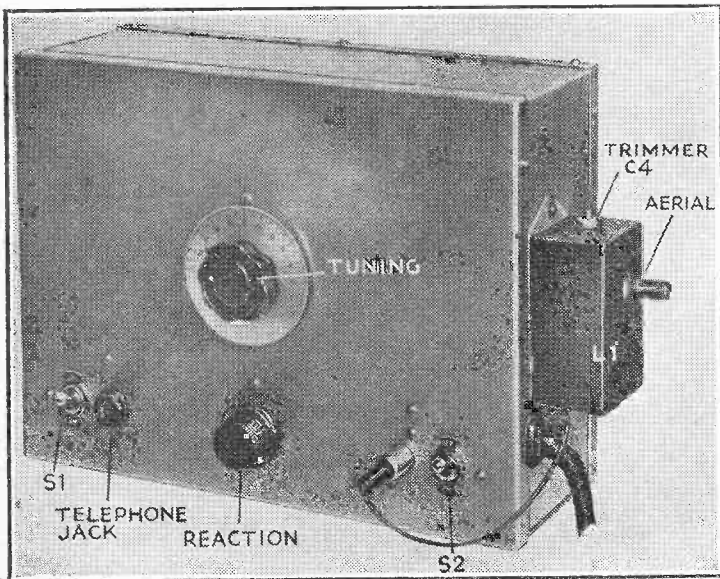

Layout of controls on the front panel. The auxiliary aerial circuit is shown connected to the frame aerial socket ready for use with a short external aerial.

telephone jack to prevent damage to the output valve in the event of the plug being accidentally pulled out. A spare plug with extension leads to the steering cockpit will no doubt be fitted by single-handed yachtsmen.

Constructional Details

The chassis is housed in an aluminium case $9\frac{3}{4} \times 7\frac{1}{2} \times 3\frac{1}{2}$ in., and all the components are attached to the front panel, which may be withdrawn as a unit. The case is fixed to the bulkhead by four screws passing through rubber washers. Batteries may be installed on any near-by shelf, and are joined to the set through a four-way cable, also passing through a rubber grommet which fits in a slot in the side of the case.

Yacht DF Set—

A platform built out at right angles to the front panel 5 inches below the top of the case carries most of the components, which are disposed above and below to the best advantage from the point of view of screening. No separate screening is required for the RF coil, as it is separated from the frame and the aerial coil by the case. The aerial coil with its trimmer is housed in a small wooden box, and the low potential end of the circuit is earthed to the side of the case. A short flexible lead from the top end of the coil plugs into the socket on the front panel when the frame aerial is not in use, and a socket is provided for connecting the internal aerial wire.

Where Screening is Needed

If the layout indicated in the photographs is adopted, the wiring falls naturally and should not present any difficulty. The only screened wire inside the set is the one leading from the frame aerial socket to the tuning condenser, and thence to the grid of the RF valve. Screening cans are required for this valve and for the detector, but not for the output stage.

In conclusion, a few practical hints on DF procedure may not be out of place. The beacon stations are often very close to one another in wavelength. It is therefore advisable to operate the set in the oscillatory condition when taking bearings, and to adjust the pitch of the tuning note to fall in the frequency range most favoured by the particular 'phones in use. By this means it will be easier to concentrate on one station, as the others will give notes of different pitch at less sensitive parts of the frequency range.

A swing of about 10 degrees will be sufficient to locate readings of equal signal strength on either side of "minimum." The bearing taken may be 180 degrees out, as the simple frame gives two minima,

but the fact will be at once apparent when the reading is laid off on the chart, and it is a simple matter to plot the reciprocal bearing.

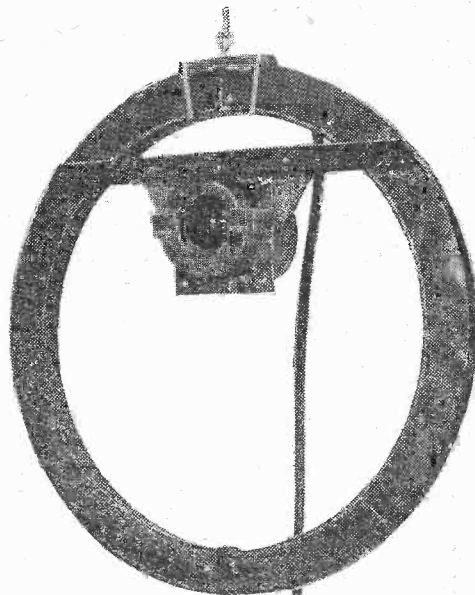

To allow latitude in installation the equipment has been divided into three units.

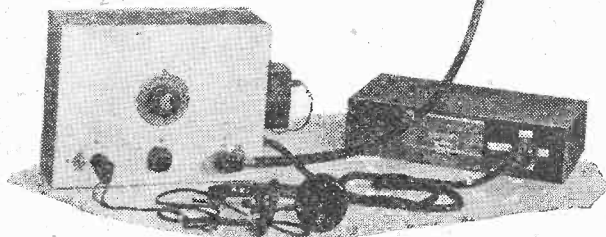

THE LIST OF PARTS

- 1 Condenser, 2-gang, 0.0005 mfd., **C1, C2**
Polar C1602
- 1 Dial Eddystone 1099
- 1 Trimmer, **C4** Bulgin CP2
- 1 Reaction condenser, 0.0003 mfd., differential, **C3** Bulgin N24
- Fixed condensers:—
 - 1 50 mfd., ceramic, **C5** Dubilier CDS1
 - 1 0.0002 mfd., **C7** Dubilier CTS620
 - 2 0.0005 mfd., **C6, C8** Dubilier CTS925
 - 1 0.002 mfd., **C9** Dubilier 4601/S
 - 1 0.005 mfd., **C10** Dubilier 4601/S
 - 2 0.1 mfd., **C11, C12** Dubilier 4601/S
 - 1 50 mfd., 12 DC, **C13** Dubilier 3016
- Fixed resistances:—
 - 1 300 ohms, 1/2-watt, **R4** Erie
 - 1 500 ohms, 1/2-watt, **R1** Erie
 - 1 650 ohms, 1/2-watt, **R5** Erie
 - 1 9,000 ohms, 1/2-watt, **R8** Erie
 - 1 75,000 ohms, 1/2-watt, **R2** Erie
 - 1 200,000 ohms, 1/2-watt, **R3** Erie
 - 1 500,000 ohms, 1/2-watt, **R7** Erie
 - 1 2 megohms, 1/2-watt, **R6** Erie
- 3 Valveholders, Octal Clix X218

A trial group of bearings of known stations should be taken, and if the average error exceeds 4 degrees look for iron near the compass, and, if necessary, prepare a deviation card.

Although the set is sensitive enough to give bearings at greater distances, they should not be relied upon if the beacon is over 100 miles away—i.e., if standard charts on Mercator's projection are used. The reason is that bearings plotted on the

- 2 Screened HF chokes, **RFC1, RFC2**
Bulgin HF8
- 1 4-pin standard valve plug Bulgin P140
- 1 Telephone plug and jacks Peto-Scott
- 2 On-off switches, single pole Bulgin S102
- 1 Coaxial plug and socket Belling and Lee L373S
- 2 Tuning coils BFO, Wearite "P" series
- 2 Valve screens, small Octal Peto-Scott
- 1 Screened output transformer, 1:1 ratio Sound Sales DF/OP
- 1 Dry battery, combined 90 volt, HT and 1.5 volt LT Siemens
- Miscellaneous:—
 - 4ft. High-frequency concentric cable, Webbs Radio AS5C
 - Two 1/4 in. plywood sheets, 2ft. square.
 - Copper foil, 0.005 in. thickness. 1/2 lb. 22
 - SWG copper wire, enamelled. 1 oz. 22
 - SWG tinned copper wire. 4 lengths
 - Systoflex. Aerial plug and socket, 18
 - SWG aluminium sheet, screws, etc. Peto-Scott
- Valves:—
 - Two 1N5G, one 1C5G. Tungstram

Next Week's Issue

REVIEW OF THE SHOW

A considered analysis, by the staff of *The Wireless World*, of technical progress and tendencies as revealed at Olympia

chart are rhumb lines, whereas the wireless wave travels along a Great Circle path. For a full discussion of this aspect of the subject the reader is referred to "Wireless Direction Finding," by R. Keen, B.Eng. (Hiffie and Sons Ltd.).

At distances up to 50 miles the error rarely exceeds 2 degrees under favourable conditions. One does not expect this accuracy when trying to manipulate the frame in a rough sea, but when the direction finder is most needed—i.e., in fog—the sea is usually calm. The knowledge that one has this valuable aid to navigation on board goes far to remove the anxiety caused by forecasts of thick weather when making coastal passages.

Henry Farrad's
PROBLEM CORNER

No. 34—Weak Signals

An extract from Henry Farrad's correspondence, published to give readers an opportunity of testing their own powers of deduction:—

2, Horns Cross,
Cowes, I.O.W.

Dear Mr. Farrad,

From what I have heard of you, I hope you may be able to advise me about our wireless. It is a three-valve superhet., but for some time past it has been used almost exclusively for listening to Bournemouth, and for that it has been quite satisfactory and as good as anybody's in this district. But we have not been so successful with other stations; the long waves are almost useless, and now that Bournemouth has closed down and Start Point is our station, we do not find it so satisfactory, in spite of it being so much more powerful. Yet our neighbours are having no trouble. As for foreign stations, they are not at all good, and there is a lot of noise and whistling, especially when the pointer indicates "Beromünster." The new Clevedon station, although I understand it is much less powerful than Start Point, and not nearly so well received by most people, is quite fair on our set, except that it tends to fade. But everybody finds this.

I'm afraid I don't know enough about the technical side of wireless to give you more information to work on, but if you can see any reason for this peculiar behaviour I should be most grateful.

Yours very truly,
Derek Farmer.

Can you suggest a likely cause and its remedy? Henry Farrad's solution is on page 183.

HT Transformer Construction

SAFEGUARDS AGAINST BREAKDOWN

EFFECTS peculiar to voltages considerably higher than those ordinarily encountered in receiver design—but now commonplace in television sets—have been described in earlier articles of this series. The choice of insulating material to withstand these abnormal pressures has also been discussed. The present article deals with the important question of HT transformers from an eminently practical angle.

IN an earlier article of this series it was pointed out that there is a distinct difference between the behaviour of moderate voltages as used in radio sets and the extra high voltages found, say, in television work. It is not "just the same thing as before, only more so." Similarly, a television high-tension trans-

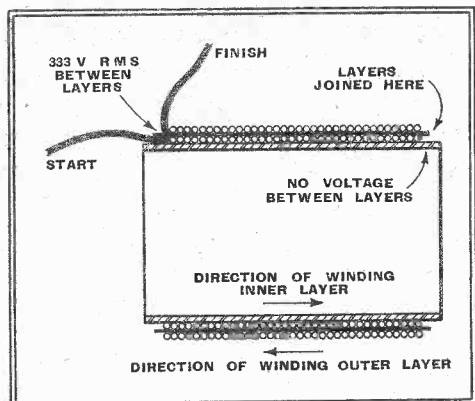

Fig. 1.—The voltage between layers varies from zero at one end to double the voltage per layer at the other end.

former is emphatically *not* an ordinary LT transformer with a lot more turns on it.

The considerations that show the necessity for a modified form of construction are not limited to high voltage phenomena alone. The output of television HT transformers is small when expressed in watts or volt-amperes because although the voltage is high, the current is correspondingly low. Hence the use of many turns of very fine wire is obviously called for. Without bothering about the high potentials involved, all these turns of very fine wire at once introduce several problems on their own account.

Fine wire is mechanically weak and the enamel insulation on it is extremely thin and therefore will not stand very much strain either electrically or mechanically. Suppose the bobbin of the transformer is of such a length that the layers of the winding are $2\frac{1}{2}$ in. long. The wire used for the HT secondary may have a diameter of 0.005 in. from which it seems that approximately $\frac{2.5}{0.005} = 500$ turns will be accommodated on each layer. A figure of three turns per volt would not be unreasonable, and this gives us 166V RMS per layer.

Referring to Fig. 1, it can be seen that the insulation between any two layers must withstand double the volts per layer. Hence, one has to cater for something of the order of 333V RMS in the hypothetical case under review. Now 333V may not seem a lot, but it is more than the insulation of fine enamelled wires will stand with safety. And this does not represent the *maximum* voltage. It is the steady working value, and considerably higher surge voltages may be expected when switching. Clearly, layers of fine wire interleaved with tissue paper in the manner of intervalve transformers will not do. The interleaving material should withstand a one-minute test at 2,000V RMS if it is to be adequate, and a good quality varnished paper will do this.

Mechanical Problems

Having chosen the materials from a theoretical viewpoint, care must be taken to see that they are mechanically "comfortable" in the finished bobbin. Excessive pressure or friction will soon destroy even a thick varnished paper. The photograph reproduced in Fig. 2 shows a bobbin roughly wound with 30 SWG wire and with one cheek removed. An inspection of the form taken by the wire shows how it tends to crush at the corners of the bobbin while it is relatively loose above the flat sides of the bobbin. Little imagination

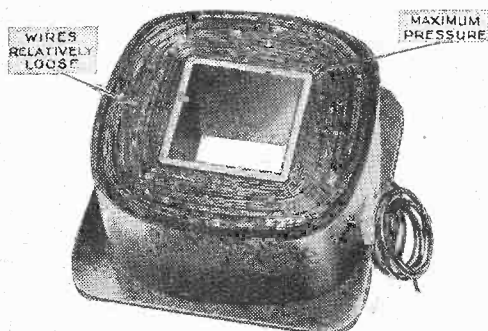

Fig. 2.—Considerable pressure is experienced by the wire at the corners of the bobbin. This tends to damage the insulating material.

is needed to realise that the corners constitute a weakness. The wire and interleaving material are bent and, at the same time, subjected to considerable pressure.

Coupled with this are the facts that (1) there is slow movement due to expansion and contraction as the transformer becomes warm on load and subsequently cools and (2) there is rapid, if minute, vibration due to magnetic and electrical stresses at the frequency of the mains. To guard against unduly rapid deterioration owing to these effects it is desirable to wind the HT secondary on the outside of the bobbin where the corners are less severe and also to pad the first few layers with suitable tape or double thicknesses of paper.

Another grave source of possible trouble that may not occur to the transformer user is to be found in soldered joints. Joints are necessary first to attach the lead-out wires and secondly, to repair breaks or when starting a new reel of wire. Anything that upsets the evenness of the winding will give rise to local pressure within the winding. Hence all joints must be small and well padded with tape so that the smoothness of the layer in which the

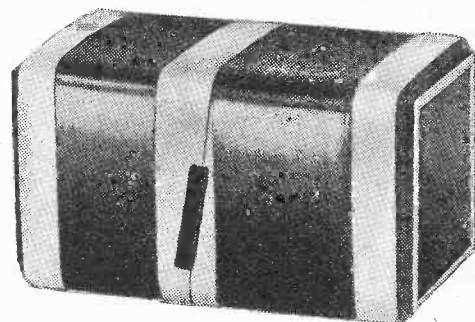

Fig. 3.—Joints must not upset the smoothness of the layer. A lump will result in local pressure and risk of breakdown.

joint occurs is disturbed as little as possible. Fig. 3 shows us how this may be done. The proper position for a joint is on the flat portion of the winding as shown and not near the corners where the pressure is a maximum (see Fig. 2).

Sharp points which tend to arise in the joints themselves must be avoided. Fig. 4 (a) shows what often happens when a joint is made by an inexperienced winder. Note the points and rough sharp edges. These are mechanically troublesome and this is aggravated by electrical phenomena in the case of HT work. As Mr. Scroggie has already explained, points are centres of intense field strength and the "corona" effect occurs more readily here. Thus we have ozone tending artificially to age the insulating material, mechanical pressure tending to crush the material and an excessive field strength only too ready to break through at the first opportunity. Fig. 4 (b) shows that a joint need not be cumbersome when tackled by an experi-

H.T. Transformer Construction—enced man with a knowledge of what is required.

We now come to the more obvious problems of insulation, and before proceeding it is essential to appreciate the significance of the term "inverse peak voltage." Take the simple case of a transformer having an HT winding of 3,500V RMS and a rectifier filament winding of 4V, 1 amp.

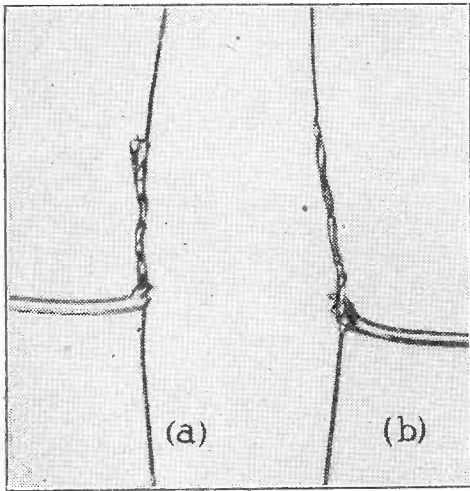

Fig. 4.—Illustrating how soldered joints can be a source of danger. Absence of roughness is very important.

Fig. 5 shows four ways in which such a transformer might be used. At (a) one end of the HT winding is earthed and therefore the other end of the winding (B) fluctuates between the peak values of +5,000V ($3,500 \times 1.414$) and -5,000V. The rectifier LT winding is maintained at a steady voltage of approximately +5,000V, from which it can be seen that

the potential difference between the LT winding and the end marked B of the HT winding varies from 0V to 10,000V. If the earth is transferred to the positive side of the circuit as at (b) the transformer will experience quite different electrical stresses. The inverse peak voltage still appears between the HT and LT windings but the LT winding is now at earth potential while the end of the HT winding labelled A is permanently at -5,000V with respect to earth. It is apparent that end B of the winding must fluctuate between 0V and -10,000V and therefore the inverse peak voltage occurs between this end of the winding and earth as well as between the windings.

Turning to Figs. 5 (c) and (d), there is no voltage between one end of the HT winding and the LT winding because they are joined together. But in the arrangement at (c) the LT swings between +5,000V and -5,000V whereas at (d) the swing is between 0V and +10,000V. Once again the inverse peak voltage has come into it.

The foregoing notes are of vital importance to all using television transformers. In the experience of the author it is usual for a transformer similar to the one described to be specified as: "HT secondary 3,500V, LT secondary 4V, 1 amp, both windings to be insulated for 5,000V." Such a specification is useless. Firstly, it is not generally necessary to insulate both ends of the HT winding for the same working voltage and secondly, although 5,000V is the peak value of a 3,500V RMS winding, the *inverse peak value* is 10,000V. When purchasing a high-tension transformer always state the outputs required from the various secondaries and attach

a rough circuit diagram showing exactly how the transformer is to be connected and do not forget to show where the earth connection goes. Having obtained the transformer to suit your requirements, remember that if you change the circuit your transformer may end its career in a cloud of smoke! Naturally, a component could be manufactured with sufficient insulation to work safely with any of the possible methods of connection, but such a transformer would be much more expensive than is necessary if only one arrangement is to be permanently employed.

It will be clear to the reader that the design of even so simple a transformer as that appearing in Fig. 5 will depend entirely upon how it is going to be used. The windings will be arranged in such a way as to keep the voltages between adjacent layers to a minimum and usually it is preferable to keep the high-potential winding on the outside of the bobbin because it is then easier to accommodate the lead-



Fig. 6.—Leakage can result in the surface of an insulator becoming carbonised and thus forming a low-resistance path.

out wire. It is not possible to describe the construction of all types of transformers, so a few typical instances will be outlined which demonstrate the general principles involved.

Some Practical Examples

Take the simple case of a transformer having only a single LT winding which is to operate at high potential. The problem is to wind the component in such a way that the LT winding shall have the maximum insulation between itself and the primary and earth or core. A glance at Fig. 7 will show that suitable insulating material will have to be placed between the LT winding and the primary and also over the LT winding in order to insulate it from the core where it passes through the windows of the laminations. A number of suitable materials are available from which to choose so that this matter is not particularly difficult. But it is less easy to look after the sides of the winding. Assuming the transformer to be air cooled, there will be only an air space plus the cheeks of the bobbin on either side between the winding and the core. Air is not so satisfactory as the majority of good insulating materials. A voltage capable of breaking down a few millimetres of the latter might jump an inch or more through air. It follows that where air is the insulating medium, ample spacing must be allowed. For this reason the LT winding

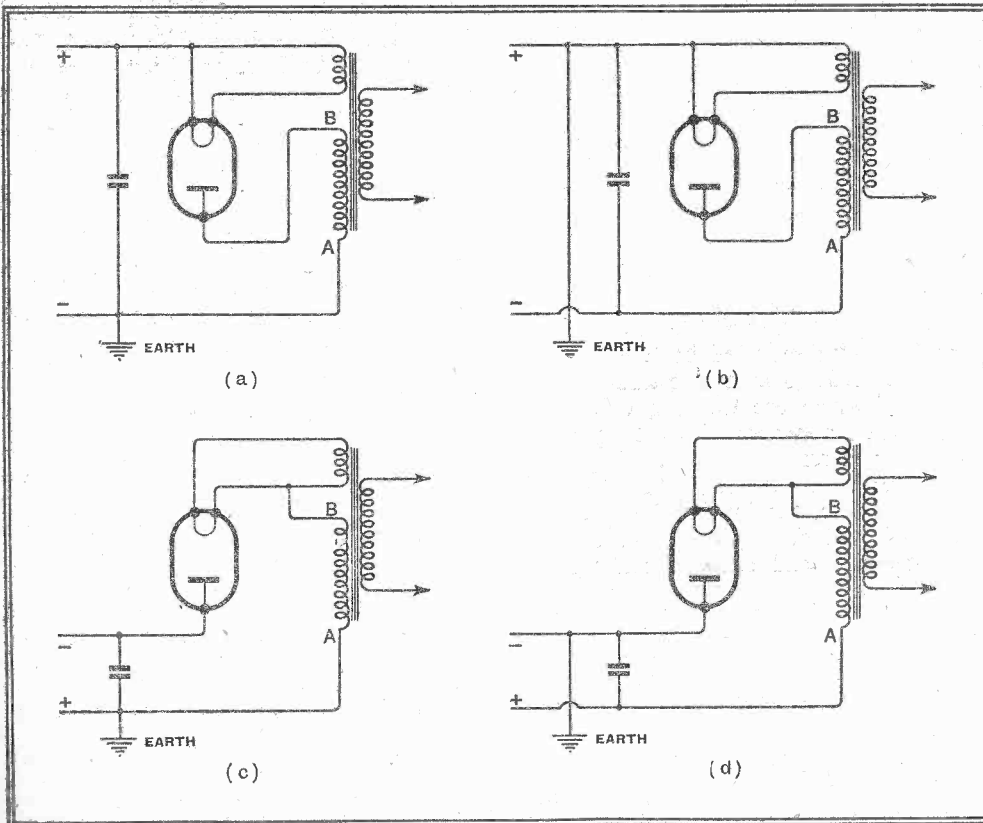

Fig. 5.—Several ways in which an HT rectifier can be arranged. The working voltages of the transformer windings are different in each case.

HT Transformer Construction—

is kept in the centre of what appears to be an excessively large bobbin.

So far we have fixed the high-potential winding so that the voltage cannot pierce through the material above or below it, nor through the air on either side. There

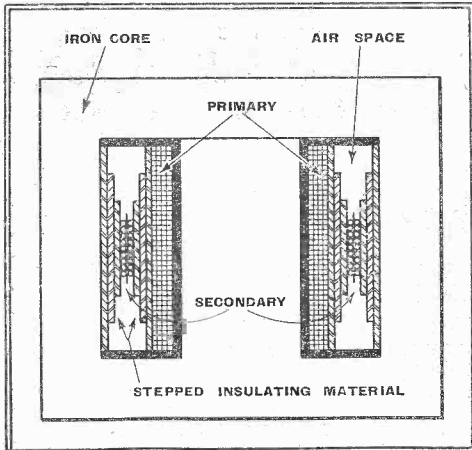

Fig. 7.—Showing how an LT secondary, working at high-potential, can be satisfactorily insulated. The points to note are mentioned in the text.

is still the question of surface leakage. If two wires are placed upon the clean dry surface of an insulator very little leakage will occur. But if the surface becomes dusty and very slightly damp it is more than likely that leakage will take place along the line of least resistance. Such leakage causes the path traversed by the current to become heated and after a long period, the surface will become carbonized and behave as a short circuit. Fig. 6 shows the result of such a calamity. This particular example was artificially produced in a relatively short time, but a breakdown of this nature in practice might occur months after the transformer has been in use. To avoid happenings of this sort, insulating surfaces must be broken up or lengthened after the style of the corrugated insulators to be seen carrying high voltage lines over the countryside in connection with the grid system. A good method of doing this is to use tape of various widths forming "steps," as shown diagrammatically in Fig. 7. A photograph of an actual transformer bobbin with the outside insulation removed in

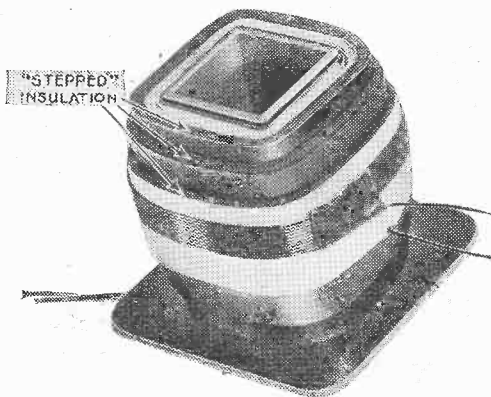

Fig. 8.—A photograph of an actual bobbin similar to the one shown diagrammatically in Fig. 7.

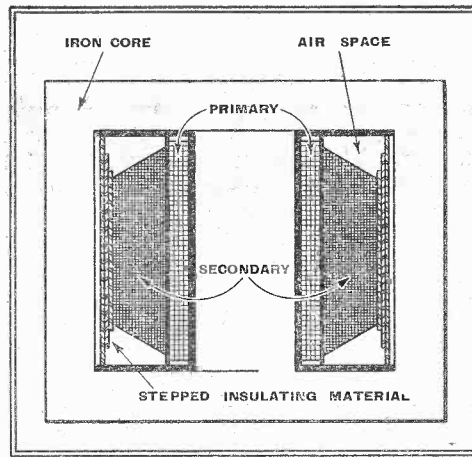

Fig. 9.—An HT secondary requires a modified form of winding technique. The air space is graded according to the working voltages of the layers.

order to show the construction is reproduced in Fig. 8.

Another variety of transformer that is frequently called for is one having a high-tension winding which is to be operated with one end earthed. The method of construction in this case is shown in Fig. 9. The HT winding is on the outside and the end to be at earth potential is immediately above the primary winding. No

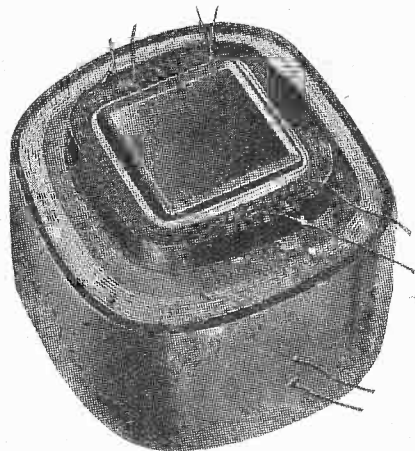

Fig. 10.—A photograph of the bobbin of the transformer specified for "The Wireless World" Magnetic Television Receiver. The outside insulation has been removed.

special precautions need be taken at this juncture. But as turns are added to the HT winding, so the working voltage increases. To allow for this the layers are made shorter and shorter, thus increasing the air space on either side of the winding. On the outside, the insulating material is "stepped" as already described and the high-potential lead brought out through the middle.

Television Transformers

As a final illustration, Fig. 10 shows the bobbin (with the outside insulation removed) of the transformer specified for *The Wireless World* Magnetic Television Receiver. The inside winding is the primary. On top of this come two LT windings working at low potential. Very ade-

quate insulation is provided; this serves the purpose of providing a smooth, soft foundation for the HT winding as well as of insulating it from the LT's beneath. The circuit of the Magnetic Television Receiver is such that one end of the HT winding is permanently at a potential of approximately 4,000V, while the other end of the winding and the rectifier LT winding fluctuate between earth potential and 8,000V; i.e., the inverse peak voltage. Since the minimum working voltage of any part of the HT winding is 4,000V, the width of this coil is made less than that of the bobbin, to allow a substantial air space on either side. This is well shown in Fig. 10. The start (inside) of the winding is the low-potential end. The high-potential end of the coil is connected internally to the rectifier LT winding, which is the outer-most winding of all. The final layers of insulation, which are not shown in the photograph, are "stepped" in a manner similar to that shown in Fig. 7 and Fig. 9.

News from the Clubs

The Medway Amateur Transmitters' Society

Headquarters: Naval Wives' Club Hall, Dock Road, Chatham, Kent.

Meetings: Tuesdays at 8.15 p.m.

Hon. Sec.: Mr. S. A. C. Howell, "Veronique," Broadway, Gillingham, Kent.

This society now has a membership of nearly fifty, and no fewer than twenty-one members hold transmitting licences. It is hoped to hold a 1.7 Mc/s field day towards the end of August, and preparations for this are well in hand.

North Manchester Radio and Television Society

Headquarters: 14, Prestwick Road, Prestwick, nr. Manchester.

Hon. Sec.: Mr. R. Lawton, "Gratton House," Whalley Road, Whalley Range, Manchester, 16.

The society is to have a stand at the Manchester Radio Exhibition, to be held in the City Hall from September 26th to October 7th. Amateur-constructed receivers and transmitters will be displayed. The society wishes to show as many photographs as possible of amateur transmitters, etc., and those who have photographs likely to be suitable are asked to send them to the secretary. It is hoped to arrange two or more lectures near the exhibition hall during the run of the exhibition. Details will be published in the *Manchester Evening Chronicle* at a later date.

Ashton-under-Lyne and District Amateur Radio Society

Headquarters: 17a, Oldham Road, Ashton-under-Lyne, Lancs.

Meetings: Wednesday evenings.

Hon. Sec.: Mr. K. Godding, 7, Broadbent Avenue, Ashton-under-Lyne, Lancs.

Work is progressing with the new club room, and a new aerial has been erected. It is hoped to arrange for a meeting at the Aerialite works very shortly.

Romford and District Amateur Radio Society

Headquarters: Y.M.C.A. Red Triangle Club, North Street, Romford.

Hon. Sec.: Mr. R. C. E. Beardow, 3, Geneva Gardens, Chadwell Heath, Essex.

The club turned out in full force at the fête on Bank Holiday, and as the result of these activities three new members were secured. An interesting talk on meters was given by a representative of Everett Edgecombe and Company.

Eastbourne and District Radio Society

Headquarters: The Science Room, Cavendish Senior School, Eastbourne, Sussex.

Hon. Sec.: Mr. T. G. R. D6wsett, 48, Grove Road, Eastbourne, Sussex.

At a recent meeting Mr. K. Wilkinson gave a lecture entitled "AC motors."

Brentwood and District Radio Society

Headquarters: "Old Basing," Alwyne Avenue, Shenfield, Essex.

Meetings: First and third Thursdays of each month.

Hon. Sec.: Mr. B. A. Pettit, "The Laurels," Worrin Road, Shenfield, Essex.

A field day in common with the Romford, Ilford, Southend, and Welwyn radio societies was held on August 20th.

Visit

RADIOLYMPIA

Aug. 23rd - Sept. 2nd (11.0 a.m. - 10.0 p.m.) 1939

Special Attractions for the technically minded amateur

This year's Radiolympia has considerably more interest for the techni-fan.

Model Factory

The model factory, working under actual practical conditions, shows almost every process of radio manufacture—such as coil winding, wire covering, wire joining, grid making, spring making, R.F. Coil adjusting, resonance test, impedance comparison, inductance comparison, ganged condenser testing, cutting and forming wires of tubular condensers, engraving, test and assembly and dry battery manufacture. Experts are in attendance to explain these processes, and to deal with any difficulties, such as interference, "fading," etc., to the serious-minded amateur. In addition, there is a revolving drum, showing the complete chassis of many of the leading manufacturers' sets.

Technical Conventions

Technical conventions will be held in the Convention Hall on the four days August 28th to August 31st, inclusive. The following subjects will be discussed by experts, and the meetings will be open for general discussion.

- (a) Short-wave technique.
- (b) High quality reproduction.
- (c) Television.
- (d) General technical topics.

Many distinguished visitors will attend and address these meetings.

Radio Theatre

SEE Your Favourite Radio Stars IN PERSON

The radio theatre at Olympia, specially built at a cost of over £5,000, is a replica of the famous "bowl" theatre at Hollywood, and is the *first theatre in the world* to be designed and constructed expressly for broadcasting AND TELEVISION.

It has a circular revolving stage, to take over 300 performers, and the auditorium, which holds over 2,500 people, is built on the "bowl," or "saucer" principle, so that everyone in the audience gets a clear and uninterrupted view of the stage.

Some of the Artistes

Picture Page

Leslie Mitchell, Joan Miller, Jasmine Bligh, Elizabeth Cowell, C. H. Middleton, Joss, Stomboli.

Variety

Bobby Howell and His Band, Troise & His Mandoliers, Charles Austin and Company, Murray and Mooney, Stanford and McNaughton, Fela Sowande, Don Philippe and Marta, The Radiolympia Girls.

Kentucky Minstrels

Scott and Whaley, Ike Hatch, C. Denier Warren, Nosmo King and Hubert, Adelaide Hall, David Evans, Kentucky Male Voice Choir

and

MISS RADIOLYMPIA 1939

the girl with the perfect radio and television personality

Broadcasting and Televising Every Day

See the batteries of cameras and microphones at work in the hands of the full staff of B.B.C. experts.

TELEVISION

Television is the keynote of Radiolympia 1939. Apart from the 64 sets constantly working in "Television Avenue," literally HUNDREDS of sets will be receiving continuously throughout the exhibition This is the greatest demonstration of television the world has ever seen.

Come and Be Televised Yourself

Special facilities for organised technical parties

Radio Manufacturers' Association,

59, Russell Square, London, W.C.1

Telegrams: OIARION, Westcent, London

'Phone: MUSeum 4031

Mention of "The Wireless World," when writing to advertisers, will ensure prompt attention.

PREMIER 1940 RADIO

AMPLIFIERS

A NEW RANGE OF 7 HIGH FIDELITY P.A. MODELS

Designed along the most modern lines and incorporating the very latest developments in radio technique, these amplifiers can be relied upon to give a continuous dependable performance.

	Kit with valves	Complete wired and tested
3-watt A.C.	£2 0 0	£2 15 0
3-watt A.C./D.C.	2 0 0	2 15 0
6-watt A.C.	5 5 0	6 0 0
8-10 watt A.C./D.C.	4 10 0	5 5 0
15-watt A.C.	5 15 0	7 0 0

Black Cracked Steel Cabinet 15/- extra.

PREMIER 15-watt MOBILE AMPLIFIER

Designed for Universal 6-volt Battery and 200-250 volts A.C. operation. Change-over from Battery to Mains operation merely consists of changing over two cables—a matter of seconds only.

Two Input Channels, Variable Tone Control, Beam Power Output. Completely self-contained, both Amplifier and Power Pack being built as one Unit.

Complete with Valves..... Price **£10.10.0**

PREMIER 25-watt MOBILE AMPLIFIER

Will work on 200-250 volts A.C. mains or alternatively from a 12-volt Car Battery. For Elections, Fair Grounds, Amusement Parks, in fact for any indoor or outdoor announcements, this Sound System will provide the most economical way of holding the attention of large audiences.

COMPLETE AMPLIFIER with all Valves and power supply for A.C. Mains and 12-volt Battery..... **£16.16.0**

See Catalogue for full description.

We haven't room here to tell you all about our new lines, but details of our vast range will be found in the new

PREMIER 1940 CATALOGUE

111 PAGES PRICE 6d.
Over 20 Pages of British and U.S.A. Valve Data, Receivers, Transmitters, Amplifiers, Components.

GET YOUR COPY TO-DAY!

PREMIER VIBRATOR POWER UNITS

Easily the most suitable Unit for obtaining H.T. from a Car Battery. By connecting the Vibrator Unit to a 6 or 12 volt Car Battery, you have an immediate 230 v. 60 cycle supply available for any standard A.C. apparatus. Vibrator Power Units also solve the problem of obtaining power in emergencies.

Complete with Radio Frequency Filters for All-Wave Equipment. No adjustment, no fitting, just plug in!

Type 6175 230v. AC. 75 w. from 6v. Battery... **£4 19 6**
Type 12175 230v. AC. 75w. from 12v. Battery... **4 19 6**
Type 121120 230v. AC. 120w. from 12v. Battery **6 6 0**

PREMIER VIBRATOR BATTERY ELIMINATORS

Flexible heavy-duty power supply Units designed to provide the most dependable and economical method of obtaining high tension supply from a 6-volt Car Battery. Each unit is completely shielded and incorporates smoothing choke, Condensers and Radio Frequency filters. Perfectly smooth filtered D.C. output that will operate any apparatus from 10 to 2,000 metres.

Alternative outputs of 250 volts or 150 volts D.C. at 50 mA. are provided.

Consumption from a 6-volt Battery: 250 volts at 50 mA., 3 amps.; 150 volts at 50 mA., 2 amps.
Type VP250..... Complete **£2.19.6**

NEW "5 v. 5" COMMUNICATIONS RECEIVER

5-VALVE SUPERHET, 12-2,000 m. IN 5 WAVEBANDS.
● Beat Frequency Oscillator. ● 2-Speed Band-Spread Control. ● A.V.C. Switch. ● Send-Receive Switch. ● Iron-cored IF's. ● Phone Jack. ● Over 4 watts Output. ● Illuminated Band-Spread Dial.

Provision for single wire or Di-pole Aerial. International Octal Valves for 200-250 v. mains (A.C.). Built into Black Crackle Steel case providing complete screening. 10 1/2 in. M.C. Speaker in separate steel cabinet to match Receiver. Complete with all tubes and Speaker **£8.8.0**

NEW 10-15-WATT ALL-BAND TRANSMITTER

A really compact self-contained T.X., which can be used for 'Phone or C.W. on all bands.

A 6L6 is used as a modulated oscillator in a tri-tet circuit, allowing a fundamental and second harmonic operation, without coil changing, from any one Xtal.

A 6CS speech amplifier is R.C. coupled to a 6L6 modulator, giving approx. 9-10 watts audio. A 400-volt power supply with generous smoothing gives completely hum-free output.

In steel cabinet, black crackle finish, 12in. x 9in. x 8in. Complete with Xtal and coils for 7 and 14 mc. operation..... **£10.10.0**

NEW 25-WATT PHONE & C.W. TRANSMITTER

6L6 C.O. is used for fundamental operation or in tri-tet circuit for second harmonic operation. The drive from this stage is more than sufficient for the T.20 P.A. stage in a very low-loss lay-out. The modulator is designed to plate modulate the P.A. stage 100 per cent. Beam Power output tubes type 6v6 in Class AB1 push-pull. R.C. Coupling throughout. Frequency response 40 to 8,000 cycles. Generous Power Supply. Two high-grade M.C. Meters. 3 Keying Positions. Built on 39in. three-tier Relay Rack. Complete with all Valves, 7 mc. Xtal to your choice and all coils for 7 and 14 mc. operation. Price **£21.0.0**

PREMIER U.S.A. QUARTZ TRANSMITTING CRYSTALS
7 mc. Band, 10/- each, with Calibration Certificate. Enclosed holder and base, 3/-.

PREMIER RADIO CO.

ALL POST ORDERS to : JUBILEE WORKS, 167, LOWER CLAPTON RD., LONDON, E.5 (Amherst 4723)

CALLERS to : Jubilee Works, or 169, Fleet St., E.C.4 (Central 2633) or 50, High Street, Clapham, S.W.4 (Maccanlay 2381)

ALL-BRITISH

LOW-LOSS CERAMICS

OF HIGH STABILITY AND MECHANICAL STRENGTH

FREQUENTITE (LOW POWER FACTOR)

NEW FREQUENTITE "S" (ULTRA-LOW POWER FACTOR)

FARADEx (HIGH PERMITIVITY)

OLYMPIA STAND

61

Ask for new illustrated catalogue S.P.10

STEATITE & PORCELAIN PRODUCTS LTD.

STOURPORT-ON-SEVERN, WORCS.

LONDON OFFICE : THAMES HOUSE, MILLBANK, S.W.1

Telephone : Stourport 111. Telegrams : Steatite, Stourport.

AGENTS : J. STONE & CO., CALCUTTA. ASSOCIATED ENGINEERING & CABLES PTY. LTD., MELBOURNE. ALLIANCE ELECTRICAL CO., WELLINGTON, N.Z. BLANE & CO. LTD., JOHANNESBURG. JOHNSON & FLETCHER LTD. BULAWAYO, & Offices of Imperial Chemical Industries Ltd. throughout the world.

Mention of "The Wireless World," when writing to advertisers, will ensure prompt attention.

OLYMPIA 1939

AUGUST 23rd TO
SEPTEMBER 2nd.
11 a.m. to 10 p.m. DAILY

A FULL report of the Radio Show, in which the exhibits on individual stands are described, appears in the following pages. It is hoped that this review will be found a useful guide for visitors to Olympia, and that it will also serve as a permanent record of the activities of the British Wireless Industry for the 1939-40 season.

STAND-TO-STAND REPORT

AERIALITE (60)

Specialising in aerials, this firm is showing a wide variety of Mastatic aerials, included among which are four television types. These range in price from 15s. to 45s.

Co-axial cables, Aerialite wires, Nomast aerials, fixing brackets, indoor aerials, and a host of small but important accessories are also shown.

Aerialite, Ltd., Castle Works, Stalybridge, Cheshire.

ALBA (37)

One of the most ambitious of the Alba range of receivers is the Model 855, in which an eight-valve superhet. chassis is fitted. It is an all-wave model having two short-wave ranges, and embodies this firm's Presto-tune system, giving a selection of eight stations by press buttons, and an automatic release when manual tuning is required. The maximum undistorted output is 16 watts, and the price is £16 16s. Another all-wave set but with one short-wave range is the Model 510, which takes the form of a table radio-gramophone, yet measures only 23in. x 14½in. x 13in.

A press-button control panel for wave-band switching, tone and on-off is employed, and the price for AC operation is £12 12s. An AC/DC version costs £15. Presto-tune is used in the Model 845, a five-valve all-wave AC set, and in the Model 745, which is a radio-gramophone version of the first-mentioned. Both are all-wave sets, having two short-wave ranges, eight stations press-button selected, in addition to manual tuning. The Model 745 costs £25 4s., and an automatic record changer can be added for £4 4s. extra.

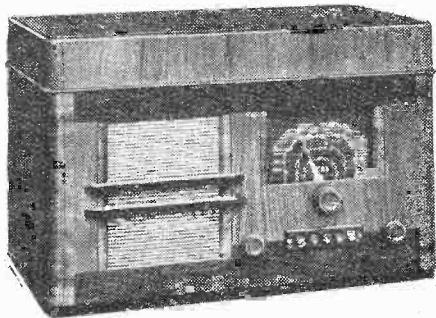

Alba Model 510 all-wave table radio-gramophone.

In addition there are some battery sets, one an all-wave model, and a small portable.

A. J. Balcombe, Ltd., 52-58, Tabernacle Street, E.C.2.

ANTIFERRENCE (10)

This exhibit comprises television aerials and twelve different types are shown at

prices ranging from 26s. 6d. to 53s. 6d. The cheaper models are made with steel rods, but aluminium is employed for the other types. The aerials are available as dipoles with or without reflectors and designed for three different methods of mounting. A special feature is made of this firm's installation service.

Antiferrence, Ltd., 176, Wardour Street, W.1.

ARMSTRONG (69)

The production of radio chassis for incorporation in the purchaser's own cabinet is the speciality of this firm. The new season's programme comprises nine models, ranging in price from £7 18s. 6d. to 17 guineas.

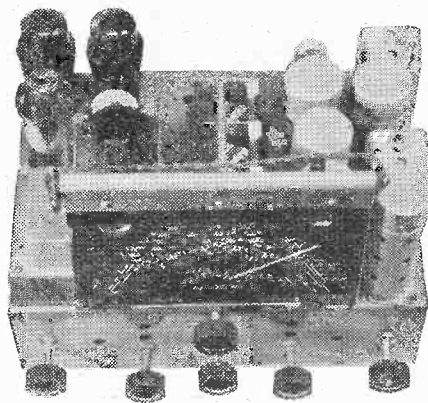

Armstrong Model SS10 "superhet-straight" receiver.

One of the most interesting is the Model SS10 with independent "straight" and superhet. circuits for high-quality and long-distance reception. The resistance-capacity-coupled push-pull output stage makes use of triodes and is rated at 8 watts. There are ten valves, including rectifier and tuning indicator, and the price is 10 guineas.

Another model which should find a ready market is the AW38 all-wave radio-gram. chassis with a 6-watt output stage. This receiver has eight valves including the rectifier and tuning indicator, and the price is 8 guineas.

One of the cheapest models in the series is provided with press-button tuning and is supplied complete with 8in. loud speaker.

Armstrong Mfg. Co., Walters Road, Nags Head, Holloway, N.7.

B.I. (20)

This stand is devoted to a display of wires and cables, copper and aluminium sheet, soldering materials, earthing rods, and condensers. The last cover an enormous range from low-voltage tubular types to high-voltage models in steel containers. Electrolytic condensers are also shown, as well as

special tropical models and dwarf condensers.

British Insulated Cables, Ltd., Prescott, Lancashire.

BAIRD (27)

As might be expected, this stand is devoted to television receivers, of which there are three main models. Each, however, is available in different cabinet styles, and one is combined with a broadcast receiver. Types T25 and T26 are the same, apart from the sound equipment, and give a picture 20in. by 8in. The vision receiver is a straight set with two RF stages, diode detector, and one VF stage with secondary emission valves. There are six tuned circuits, arranged as band-pass filters, and a sound rejector. The CR tube is fed with a DC restoring circuit. Magnetic deflection and focusing are used with hard-valve saw-tooth oscillators. The T26 is equipped for television sound only, but the T25 is provided with a three-band broadcast set in addition. It is priced at 47 guineas, whereas the T26 is 40 guineas. A booster amplifier is available for use at great distances from Alexandra Palace.

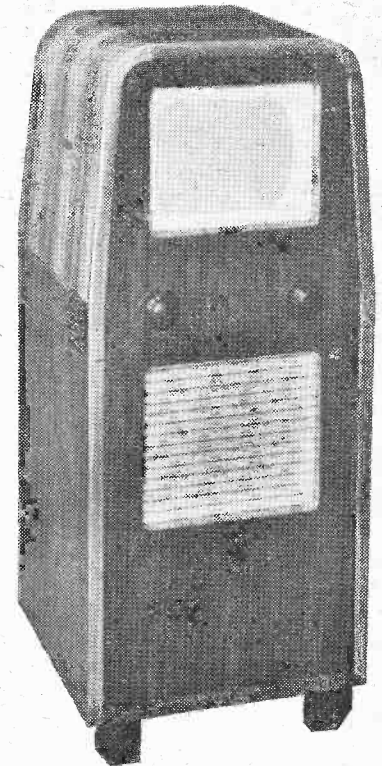

The Baird Model T28 television receiver.

Both larger and smaller receivers are listed. The T27 gives a picture 12in. by 9½in., and costs 48 guineas. In common

Olympia 1939—

with all models produced by this firm, direct viewing is adopted, and magnetic deflection and focusing are used. The smaller sets have a 9in. tube giving a picture 7½in. by 6½in. The T24 is a table model at 30 guineas, whereas the T28 is a console type.

Baird Television, Ltd., Crystal Palace, Aneley Hill, S.E.19.

BELLING-LEE (3 & 26)

Aerials for ordinary broadcast as well as for television reception form a prominent part of this exhibit. The new Skyrod vertical aerial is an anti-interference pattern and is now fitted with a new-style plug-in aerial transformer in a small weatherproof container. It also embodies a lightning arrestor, and as the metal supporting mast is earthed perfect protection is given to the receiver.

The aerial is in 6ft. lengths and can be raised to a height of 18ft. A redesigned chimney fitting enables the aerial to be securely fixed by a single lashing where hitherto two were used. Complete with 12ft. mast, 12ft. aerial, and all accessories, the price is £5 15s.

Television di-poles with and without reflectors in weatherproof all-metal construction are shown. A hollow mast is employed, and the low-impedance feeder is brought down inside the mast. These aerials are designed to withstand the fiercest gales, and the protected down-lead ensures freedom from fracture at the point of contact, so that once erected they will need very little attention. Di-pole, reflector, mast, fittings, and 75ft. of feeder cost £7 10s. 6d., but as all the parts are obtainable separately the cost would be reduced where an existing mast could be employed.

So far nothing has been said of the host of small items made by this firm. There are plugs and sockets in abundance, fused mains connectors, and some special moulded parts, such as valve-holders and sockets designed for the high-voltage circuits of television sets. All kinds

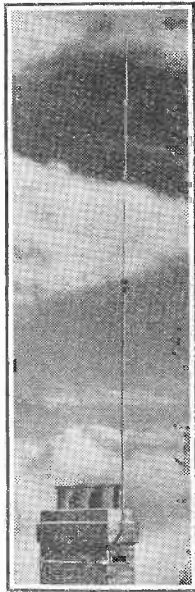

Improved Skyrod Aerial made by Belling-Lee.

of interference suppression devices for wireless as well as for domestic electrical apparatus are made by this firm.

Belling & Lee, Ltd., Cambridge Arterial Road, Enfield, Middx.

BOSCH ELECTRONICS (18)

The Augetron is the main exhibit of this firm. It is a six-stage electron-multiplier of the grid-controlled type. With an indirectly-heated cathode rated to consume 1.5 A at 2 volts, the multiplier requires 300 volts per stage, or nearly 2,000 volts total. With 10 mA in the final stage the overall mutual conductance is about 40 mA/v.

The input capacity is 4 μF. and the output 7.50 μF., and at 45 Mc/s the input resistance is over 20,000 ohms. It is claimed

that voltage amplification of the order of 1,000 times can be secured from a single multiplier even in its television applications.



Bosch Electronics Augetron.

Vacuum Science Products, Ltd., 166, Weir Road, Balham, S.W.12.

BULGIN (62)

As something of the order of 300 new items have been added to the catalogue of Bulgin components, it is obviously impossible to do more than mention just a few.

The television aerials have been redesigned, many new pilot lamps and holders introduced, additions made to the range of silvered-mica condensers, some new models added to the series of fuses and fuse holders, nearly one dozen new knobs of various kinds have appeared; one could go on in this way for quite a long time.

Taking a few individual items, there is a range of Unit coils, so-called because each coil is separate and not part of a set. These cover all wavelengths from 7 to 2,600 metres, and comprise aerial, RF, and oscillator coils. They have type numbers C86 to C104, and cost between 1s. 9d. and 2s. each.

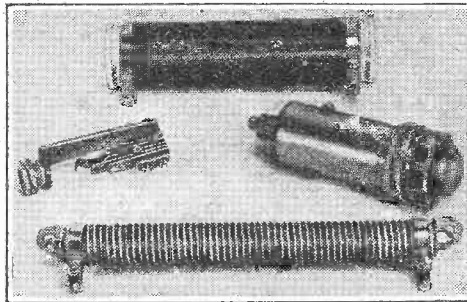

Bulgin heavy-duty resistances, new jack and signal lamp.

Covering practically all requirements is a range of small spring-leaf-type jacks having type numbers of J11 to J22, and these are priced at 1s. to 2s. 6d., according to the type.

Resistances of from 2 ohms upwards wound as a single layer on heat-resisting formers and designed for use in AC/DC sets, transmitters, and in electrical apparatus generally, can be obtained in sizes of from 4 watts to 100 watts dissipation. There are also some 80-watt type in the spiral-cord resistances wound on fireproof formers.

The HT vibrators have been improved, and a new series both of the synchronous, i.e., self-rectifying, and non-synchronous types are now available. A standardised five-pin base is fitted to both kinds, so they become easily interchangeable. They are made for DC input voltages of from 2 to 32 volts, the former in the synchronous type only and rated at 5 watts, while the higher voltage pattern can be supplied for handling between 15 and 18 watts. Some new vibrator transformers are also available.

A. F. Bulgin & Co., Ltd., Abbey Road, Barking, Essex.

BURNDEPT (54)

Two television receivers are included in the Burndept range this year. They are the Model 306 for sound and vision with a 10in. x 8in. picture, and the Model 329

giving a picture 7½in. x 6in., and including a broadcast receiver with push-button tuning. The prices are 45 guineas and 39 guineas respectively.

In addition to the Model 309 superhet. portable, there are ten broadcast receivers to choose from, including three radio-gramophones.

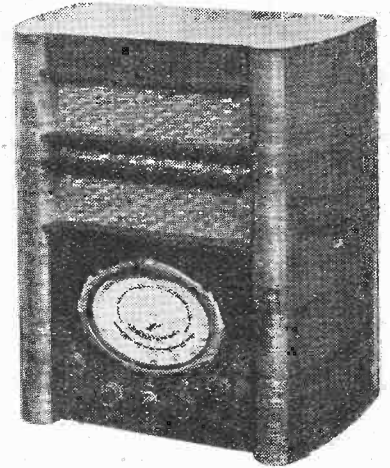

Burndept Model 290.

The Model 290 table model superhet. for AC mains has a push-pull output stage with the high rating of 18 watts. It tunes down to 13.5 metres and has four wavebands. The same chassis is incorporated in the Model 303 radio-gramophone, which sells at 22 guineas.

The model 316 radio-gramophone at 28 guineas is fitted with a record-changer of simple design playing eight 10-inch or 12-inch records, and in the Model 285 at 40 guineas the record-changer plays eight assorted records up to 12in. diameter.

Burndept, Ltd., Light Gun Factory, Erith, Kent.

BUSH (34)

An unusual feature of many of the AC sets produced by this firm is the use of a triode output valve. In addition the Model PB65 has an RF stage for SW use only. On medium and long waves the triode-hexode frequency-changer has a pre-selector, but on short waves an RF stage is included. There is one IF stage, and detection, AVC, and first-stage AF amplification are obtained from a duo-diode-triode. This is followed by a second triode AF stage, and then comes the triode output valve.

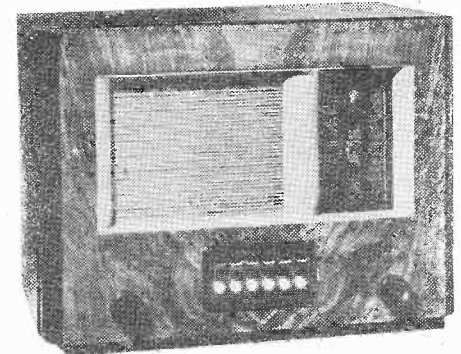

Bush button battery superheterodyne, Type BA61.

The set has push-button tuning, giving four MW and two LW stations, a short-wave band extending from 16.5 metres to 51 metres, and variable selectivity. It is priced at 14½ guineas. A similar receiver without

Olympia 1939—

the RF stage is the PB63 at 12½ guineas. At the same price there is a battery set—the BA63. This starts off with a triode-

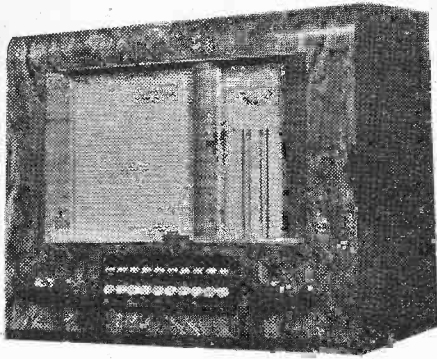

Bush button Type PB63 AC receiver.

pentode frequency-changer and has one IF stage before the duo-diode-triode detector, AVC source, and AF stage. This is transformer-coupled to a QPP output valve. Push-button tuning is provided. A similar battery set but with a pentode output valve is also available—this is the BA61.

AC/DC sets are also on view, in addition to television receivers. One of these gives a 10in. by 8in. picture and is combined with an all-wave receiver having push-button tuning and a triode output valve. It is listed at 47 guineas. The vision receiver has three RF stages, diode detector, and one VF stage; secondary emission valves are used. Gas-triodes are employed for the saw-tooth oscillators, and followed by pentode amplifiers.

Bush Radio, Ltd., Power Road, Chiswick, W.4.

CAMEO (21)

A range of portable receivers is shown on this stand, and although some are AC/DC models and some all-wave sets, reception in all cases is effected on the built-in frame aerials.

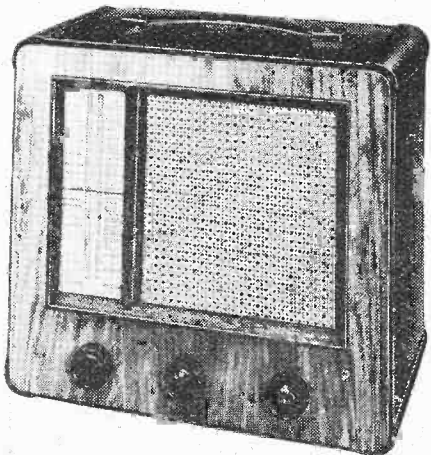

Gordon Elf all-dry battery portable model A.R.P.

In the Model AWB, a six-valve battery superhet., AVC is used on the AF stage preceding the QPP output valve, as well as on the RF, FC, and IF stages, while another interesting feature of this set is the inclusion of a noise suppression stage.

Optional LT accumulator or a 3-volt dry battery can be used for the filament supply in the Model ARP, a barretter serving to regulate filament voltage when dry-battery LT is employed. This set costs £7 17s. 6d.

All the battery receivers have a small fuse lamp to safeguard the valves in the event of the LT leads accidentally falling

on the HT battery when changing the accumulator.

Gordon Elf, Ltd., 55, Rathbone Place, W.1.

CARR FASTENER (65)

This stand is devoted to a display of every conceivable variety of small metal parts. Over 100 different types of solder-tag are shown, in addition to a multiplicity of terminals, clips and contacts.

Carr Fastener Co., Ltd., Nottingham Road, Stapleford, Notts.

CELESTION (25)

The progressive detail improvements in design which have been incorporated in the Celestion extension loud speakers do not justify any change in type numbers, and the whole range is being maintained without alteration in price. The "Senior Auditorium," "Sixty-Six," "Fifty-Five," and "Duode 33" units will require no introduction to our readers, but they may not have

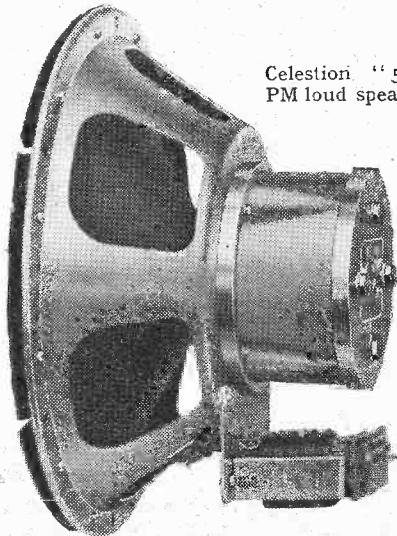

Celestion "55" PM loud speaker.

yet become acquainted with the fact that the constant impedance volume control unit used in some of the cabinet models is now available separately, priced 10s.

Cyril French, 29, High Street, Hampton Wick, Kingston-on-Thames.

COSMOCORD (72)

A new gramophone turntable unit, the Model AC9/M9, has been introduced. It incorporates a new form of floating suspension and a redesigned magnetic pick-up with an average output of 0.75 volt. The price for AC operation is £2 19s. 6d., and a "Series 3" crystal pick-up can be fitted for 12s. 6d. extra. A universal AC/DC model is also available, and the motor units are sold separately.

The Model 500 pick-up head, at 7s. 6d., and the "Ad-a-Gram" playing desks are being continued.

Cosmocord, Ltd., Cambridge Arterial Road, Enfield, Middx.

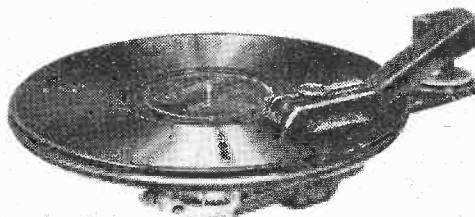

Cosmocord Model AC9/M9.

COSSOR (48)

A wide range of broadcast receivers is to be found on this stand, and an interesting point is the almost universal adoption of a

triode output valve in the AC models. The Type 81, for instance, has a 2XP output valve, which is preceded by a duo-diode-triode. There is a triode-hexode frequency-changer and one IF stage. It is a three-band set, and there is a mechanical push-button system; AVC is, naturally, included, and, in common with other receivers produced by this firm, permeability trimming is used in the IF transformers. It is priced at 10½ guineas. The battery and AC/DC sets have pentode output valves.

A push-button car-radio receiver is now made by this firm, and is available in 6 v. or 12 v. types. It is of the two-unit type; one contains the frequency-changer, push-buttons, volume and tone controls; the other consists of the IF amplifier, detector, output stage, loud speaker, and vibrator power supply. The installation is straightforward, and either a roof aerial or an under-car aerial can be supplied.

Among the new television apparatus shown, particular interest attaches to the Model 1210. This has a 15in. cathode-ray tube arranged for direct viewing, and provides a picture 12in. by 10in. A total of twenty-one valves is used, and a three-band broadcast set is included. For use at more than 20 miles from Alexandra Palace the 1210A is recommended; this includes three more valves and has greater sensitivity. It is listed at 56 guineas.

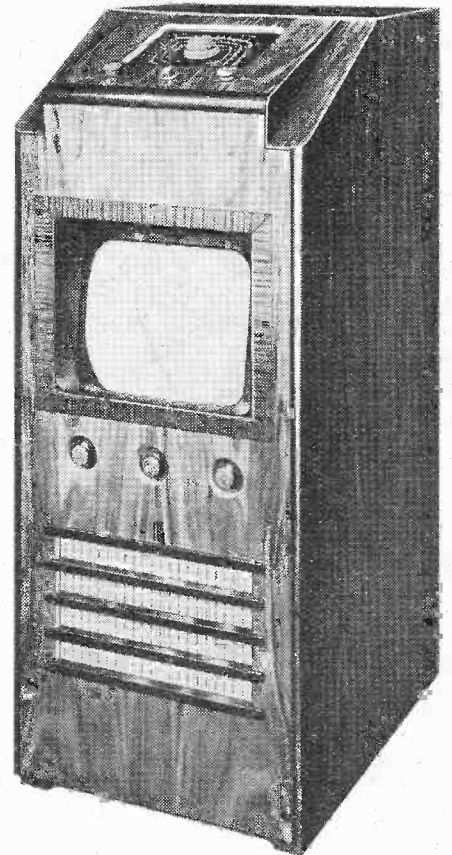

Cossor Model 1210 television receiver.

A wide range of valves of all types is shown, including many special television models and many American types.

A. C. Cossor, Ltd., Cossor House, High-bury Grove, N.5.

DECCA (44)

Prominent among the large range of receivers displayed on this stand is the Model AW6. It is a superheterodyne with frequency-changer, one IF stage, duo-diode-triode detector, AVC source, and AF amplifier and tetrode output valve. There is one short-wave band in addition to medium and

Olympia 1939—

long waves, and it is interesting to note that the band chosen is 12.5-35 metres. The makers feel that the 13-metre band is of more general use than the commonly included 49-metre band. This latter band is available in other models listed by this firm.

The Brunswick models shown include a table radio-gramophone at 12½ guineas. Press-button tuning is provided, and the receiver is a superheterodyne covering medium and long wavelengths. An output of 4½ watts is available.

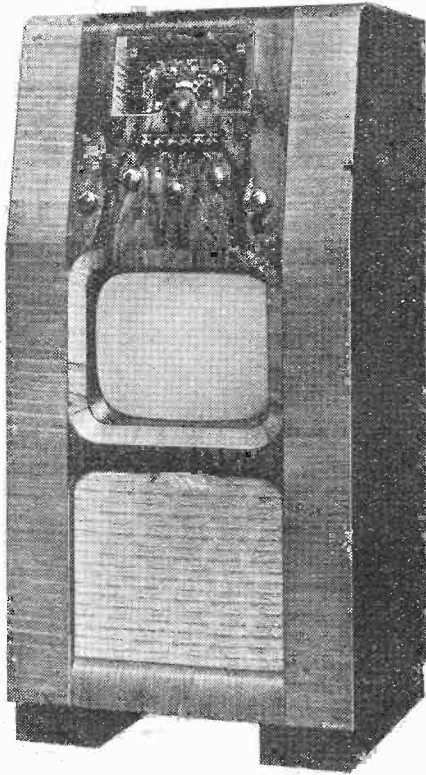

Decca 46 television and all-wave receiver.

Two television sets are shown, one including television sound only, the other having a broadcast set in addition. The picture size is 10in. by 8in. The receiver is a superheterodyne with an RF stage and frequency-changer common to both sound and vision. There are two IF stages in the vision, and one in the sound, channels.

Decca Radio & Television, Ltd., 1-3, Brixton Road, S.W.9.

DUBILIER (28)

A high-voltage paper dielectric condenser assembled in a cylindrical metal case and arranged for fixing so that the terminals are at the top, or, if preferred, at the bottom, where they can protrude through holes in the chassis for under-deck wiring, is among the new components shown this year. Known as the Type 25185, it is available in capacities of 1, 2, and 4 mfd. for working voltages of 1,000 or 2,000 DC at prices ranging from 6s. 6d. to 14s. each.

Other new condensers comprise a range of very small mica models with wire connections in capacities of 0.0005 mfd. to 0.0005 mfd. and for 350 volts DC working. These cost 6d. to 8d. each, according to size.

The Type 5811W is a metallised mica condenser fitted with stiffening and protecting plates. Wire-end connections are fitted, and they are made in capacities ranging from 0.00025 mfd. to 0.003 mfd. The working voltage is 350 DC.

Wound on cylindrical non-hygroscopic ceramic formers are a range of power re-

sistances for dissipating from 5 to 50 watts. A temperature rise of 250 degrees C. is per-



Dubilier power wire-wound resistance.

missible, and this temperature is taken as the basis for full rating. Sizes range from 100 to 10,000 ohms, and prices from 2s. 6d. to 5s. 6d. each.

These comprise only a few of the newer items, and there is, of course, an extensive range of high- and low-voltage fixed condensers in paper, mica, or electrolytic types.

Fixed metallised resistances are shown in sizes of from ¼ watt upwards, and there are also many different kinds of volume controls and motor car suppressors.

Dubilier Condenser Co. (1925), Ltd., Ducon Works, Victoria Road, N. Acton, W.3.

DYNATRON (1 & 39)

Following its usual practice, this firm is exhibiting receivers of somewhat specialised type. The main features are the inclusion of an elaborate variable selectivity system and adjustable whistle filter; the equipment is arranged as a straight set for local reception, and as a superheterodyne for more

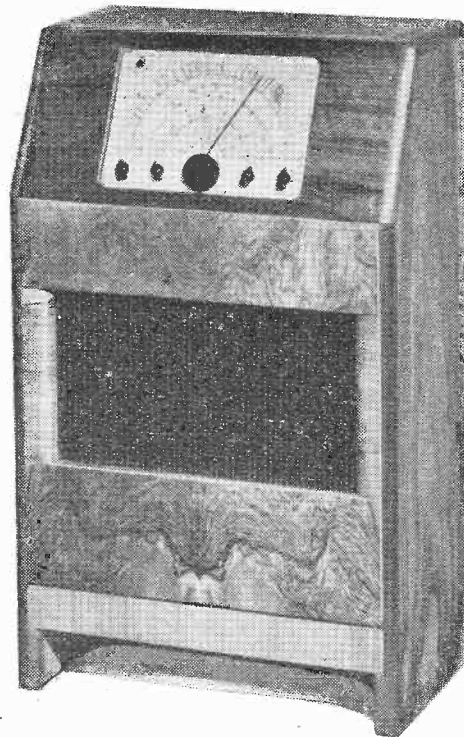

Dynatron Merlin receiver.

distant reception. Many band-pass filters are incorporated, and it is claimed that the overall resonance curve is substantially flat-topped with steeply sloping sides. Push-pull triodes are used in the AF amplifiers.

Television receivers are also shown and include a 12in. CR tube. They are available with television sound equipment only, or in combination with all-wave receivers. The largest is the Ether Emperor IV, Model 4518, with a total of forty-five valves. It is an all-wave receiver with automatic record-changer in the gramophone equipment and television.

Dynatron Radio, Ltd., Perfecta Works, Ray Lea Road, Maidenhead, Berks.

EDISWAN (23)

One of the most interesting features on this stand is a range of Mazda battery valves with filaments rated at 1.4 volts. They are intended for dry battery operation, and, except for the output pentode, consume only 0.05 A. The range includes a heptode frequency-changer, an RF pentode, a single-diode-triode, and an output pentode. They are fitted with the Mazda octal base.

The well-known high mutual conductance television RF pentodes are on view, together with gas-triode saw-tooth oscillators and other special television valves. Cathode-ray tubes, too, form an important part of the exhibit, short television tubes for magnetic deflection and focusing being on view.

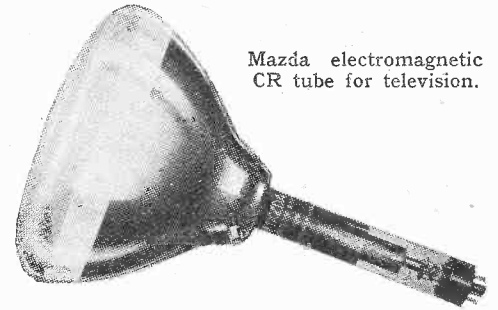

Mazda electromagnetic CR tube for television.

B.T.H. loud speakers, 'phones, and pickups are also shown.

A feature is being made of the Electroencephalograph. This is an apparatus for the examination of brain activity, and its operation is described by models and diagrams.

The Edison Swan Electric Co., Ltd., 155, Charing Cross Road, W.C.2.

EKCO (47)

The research activities of this firm have evidently been very well distributed between the requirements of television and ordinary broadcast reception, and the receivers in both catalogues are full of interesting new features.

The motor-driven "Radio Brain" has been redesigned to increase the speed of station selection, and in all press-button models now switching arrangements known as "Solo Touch" action ensure that appropriate wave range selection accompanies the

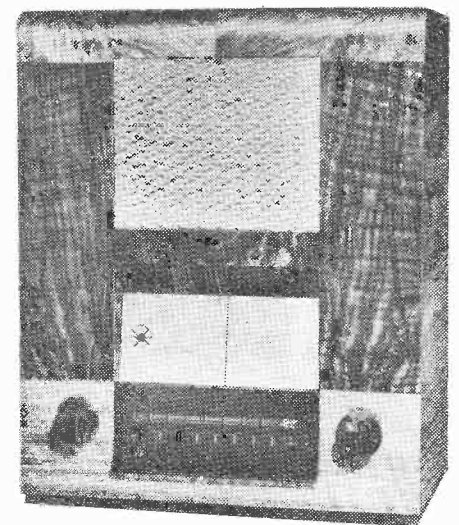

Ekco PB506 AC superhet.

switching on of the set when any button is pressed. Tone control has been extended to give either an increase or decrease compared with normal response in both bass and treble.

Olympia 1939—

A superhet. circuit is now employed in the P150 "Pick-me-up" portable, and all the AC mains receivers are fitted with sockets for the attachment of television.

Models TA201 and TA901 are the "add-on" units which have been designed for this purpose. They cost 22 guineas and 25 guineas respectively, and give picture sizes of 6½ in. x 5 in. and 7½ in. x 6 in. Tuning for sound and vision is pre-set, and the sound accompaniment is reproduced via the pick-up terminals of the broadcast receiver.

The remaining television models are the TS701 table model at 26 guineas, and a console for sound and vision only, giving a picture size of 7½ in. x 6 in. and costing 32 guineas. A single-valve line amplifier for insertion in the aerial lead-in is available for districts near the fringe of the service area. It incorporates its own transformer and rectifier, and measures 6 in. cube.

Flat-ended tubes with magnetic focusing and deflection are used in all models, and the chassis are built in three sections in a

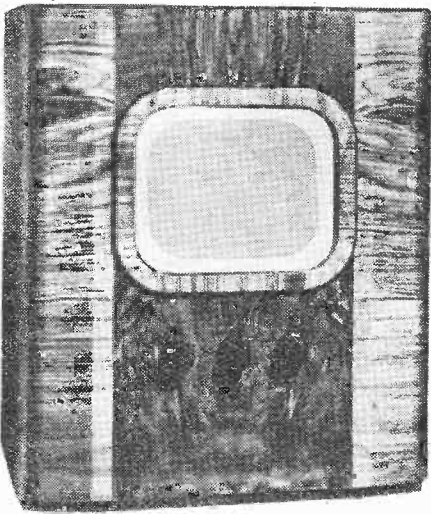

Ekco TA901 "add-on" television unit.

"scaffold" framework, which considerably reduces the dimensions and facilitates testing and servicing.

E. K. Cole, Ltd., Ekco Works, Southend-on-Sea, Essex.

ELECTRON (59)

The display on this stand consists of aerial accessories, and includes several different forms of aerial wire. An all-wave anti-interference aerial is also shown; it has a twin-wire down lead with matching transformer. Earthing mats are on view, as well as some useful perforated copper strip.

New London Electron Works, Ltd., East Ham, E.6.

E.M.I. SERVICE (100)

Though the service engineer will be mainly interested in this firm's products, a visit by anyone contemplating installing a television set will be well repaid. On the stand is shown a variety of television aerials, some taking the form of compressed dipoles a little more than a yard in length and suitable for erecting indoors if necessary.

There is one described as a Tilted-wire aerial that has very marked directional properties, but at the same time gives a wider frequency response than is usual with this kind of aerial. Its main applications are cutting out interference and improving definition.

There is a wide-band RF amplifier suitable for use when several television sets are used for demonstration purposes.

Among the servicing equipment is a television signal generator, an all-wave test oscillator covering 5.5 to 3,300 metres, an oscilloscope for general servicing use, and a frequency modulator (wobulator) for use with it.

The range of test instruments includes also a capacity tester, a Super-Sensitive Analyser—a multi-range test set—with a resistance of 20,000 ohms per volt. This costs

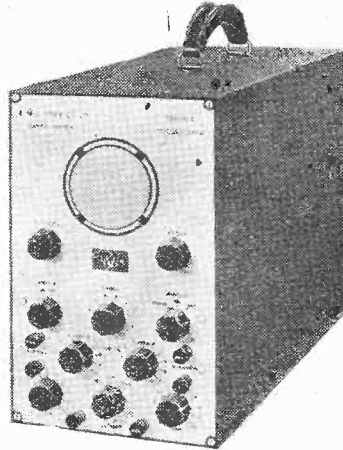

E.M.I. Service general-purpose oscilloscope.

£16 16s. In addition there is a wide range of PA equipment.

E.M.I. Service, Ltd., Sheraton Works, Hayes, Middx.

ERIE (13)

The main exhibit of this firm is fixed resistances, the ½- and 1-watt types being available in insulated form. The Type M volume control is fitted with a long duralumin spindle, which can readily be cut to any required length. This is to reduce the number of replacement parts which need to be stocked, since receivers vary greatly in the lengths of the shafts used.

Vitreous wire-wound resistors are also shown, in addition to ignition-interference suppressors. Fixed condensers in capacities from 5 μF. to 600 μF. and of the silver-ceramic type are on view with still larger capacities in the silver-mica range. They are all protected and insulated.

Erie Resistor, Ltd., Carlisle Road, The Hyde, N.W.9.

EXIDE & DRYDEX (2)

Accumulators and dry batteries in a variety of types are shown. The Hycap series has been enlarged, and so also has the unspillable range, which now contains one of the correct size and capacity for almost every portable set in existence.

A special feature is made of the new Drydex Pack batteries for portables fitted with the latest 1.5-volt valves, and also of midget HT batteries and accumulators for use in deaf-aid devices.

The Chloride Electrical Storage Co., Ltd., 205-231, Shaftesbury Avenue, W.C.2.

FERGUSON (17)

Four mains and one battery table model provide sufficient variety of specification to cover most needs and purses. The Model 901 at 9 guineas fulfils the basic requirements for efficient reception of short-, medium- and long-wave stations, while the Model 905, at 16 guineas, includes a low-noise RF stage permeability push-button tuning, provision for reception of television sound, and a 10-watt output. The curved tuning scale is well placed for manual tuning. A console and two radio-gramophones complete the range of broadcast receivers.

The television receivers are both 18-valve consoles, the Model TC918 at 35 guineas

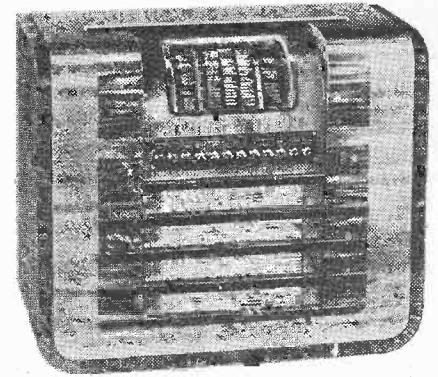

Ferguson Model 905.

being provided with a 9 in. tube and the Model TC1218 at 40 guineas a 12 in. tube giving a picture size of 10 in. by 8 in.

Ferguson Radio Corporation, Ltd., 105-109, Judd Street, W.C.1.

FERRANTI (41)

The 1939-40 programme of this firm comprises three television receivers, four table model domestic receivers and the Ferranti car radio set.

Tubes with a special magnetic deflection system and permanent magnet focusing are employed in the television receivers. Model T10 at 30 guineas gives a picture 7½ in. by 6 in., and may be used for reception of the sound channel only if desired. The end of the tube is protected by an armour plate glass window. In the T8 console, at 40 guineas, the picture size is 10 in. by 8 in., and in the Model T9 at 48 guineas an all-wave broadcast receiver is included.

One of the domestic receivers (Model 539) makes use of the new 1.4 volt valves and operates entirely from dry batteries. It covers medium- and long-wave stations and costs 7½ guineas (less battery).

The cheapest AC superhet is the Model 139 at 9 guineas. This includes a short-wave range from 16.5 to 51 metres and has a 4-watt output stage. Model 239 is a similar receiver with a larger tuning scale.

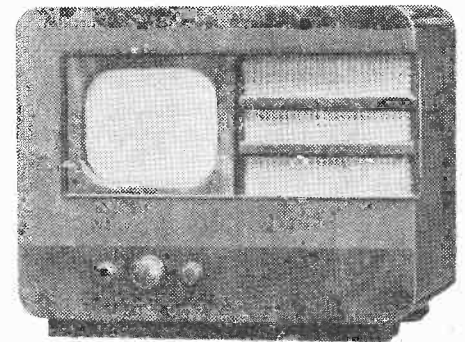

Ferranti T10 television receiver.

In the Model 439 at 12½ guineas ganged permeability tuning has been adopted for the push-button tuning system, and the manual tuning scale is of a new type with vertical coloured light bands for each waverange.

Ferranti, Ltd., Radio Works, Moston, Manchester, 10.

G.E.C. (35)

This firm is showing a very wide range of receivers; the majority of the smaller types have a single SW band. The mechanical push-button tuning system oper-

Olympia 1939—

ates the waveband switching, and there is, of course, provision for manual tuning. An unusual feature is the inclusion of tone-compensation in the AF amplifier.

One of the most interesting sets is the Model 4010. This is a large receiver designed primarily for overseas use. It covers 11-2,100 metres in five bands. There are an RF stage, frequency-changer, two IF stages, a duo-diode-triode detector, AVC source and tone-compensator, AF stage, and push-pull tetrode output stage. There are independent bass and treble tone controls. A pair of matched speakers is used to handle the 12 watts output. It is priced at 29 guineas.

Television receivers are also shown. In addition to an "add-on unit," there is the BT.0091 at 32 guineas. This is a console type for television only, and has a gin. tube giving a picture 7½ in. by 6 in. It is a super-heterodyne, and provision is made for using the sound channel alone. The same vision

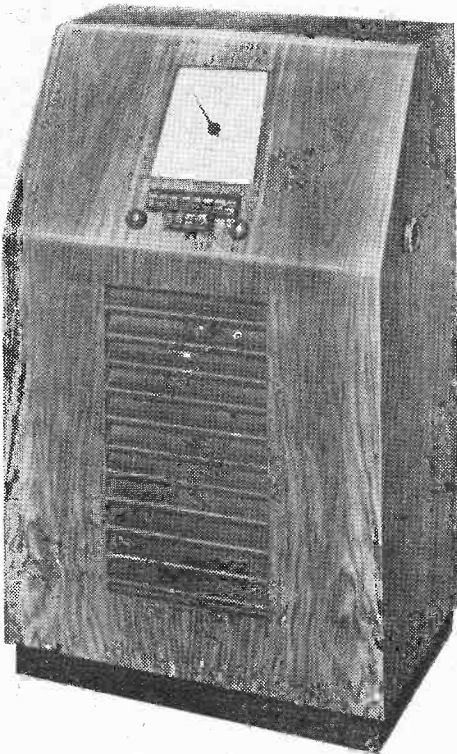

Model 4054 G.E.C. receiver with push-button tuning.

equipment is available combined with an all-wave broadcast set. This is the BT.0092 at 40 guineas. There is also a de luxe model with 12 in. tube, all-wave receiver, and automatic record-changer.

The range of Osram valves is increased by the addition of several new types. Among battery valves are four new specimens with a 2-volt filament rating; these are the X24 triode-hexode; the HD24 duo-diode-triode; the KT24 output tetrode, and the HL21 triode. The main feature of these valves is a reduction in filament current while improving or retaining normal characteristics.

High mutual conductance valves are now available in the 6.3-volt range with the octal base, and there are several new television types. There is the X62 triode-hexode with a conversion conductance of 1.75 mA/v. and two cathode connections, and the Z62 RF pentode with a mutual conductance of 7.5 mA/v. An input resistance of 4,000 ohms at 40 Mc/s is claimed.

General Electric Co., Ltd., Magnet House, Kingsway, W.C.2.

GARRARD (56)

In addition to the existing RC1A and RC4 models, two new record changers make their first appearance on this stand.

The RC10 is a popular model at £6, incorporating a new record spindle of non-slip design. It will play eight 10 in. or eight 12 in. records, and a spring mounting is supplied to minimise acoustic feed-back to the pick-up.

In the RC50 at £8, 10 in. and 12 in. records up to a total of eight can be mixed in any order. A rejection control is included, and special attention has been paid to the suppression of electrical interference.

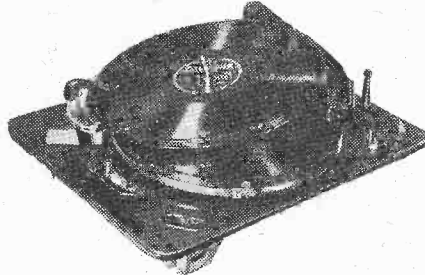

Garrard RC10 record changer.

A representative selection of turntable units and gramophone motors is also being shown.

Garrard Eng. & Mfg. Co., Ltd., Newcastle Street, Swindon, Wilts.

GOODMANS (19)

The "infinite baffle" high-quality loud speaker has undergone several changes since last year. These have been directed towards increasing the power-handling capacity and are to be found chiefly in the method of suspending the main diaphragm.

The P12 public address units, which are also in demand for use with high-power

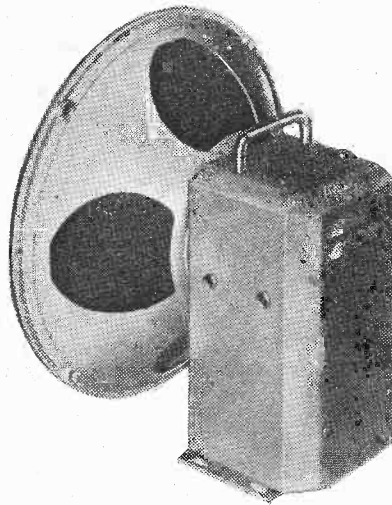

Goodmans P12 energised loud speaker.

domestic receivers, have been given suitable alternative methods of mounting, and there is a new range of high-quality output transformers of flat characteristic and low harmonic distortion. Type H4, suitable for powers up to 15 watts, costs 35s., and the Types H3 and H2 for 8 and 4 watts cost 15s. and 8s. 6d.

Goodmans Industries, Ltd., Lancelot Road, Wembley, Middx.

H.M.V. (46 & 53)

One of the most interesting of the new receivers shown by this firm is the model 1200, which is also available as an auto-

radio-gram. under the type number 1600. It is a three-band set with an RF stage and triode-hexode frequency-changer; the IF valve acts as a DC amplifier for the AFC

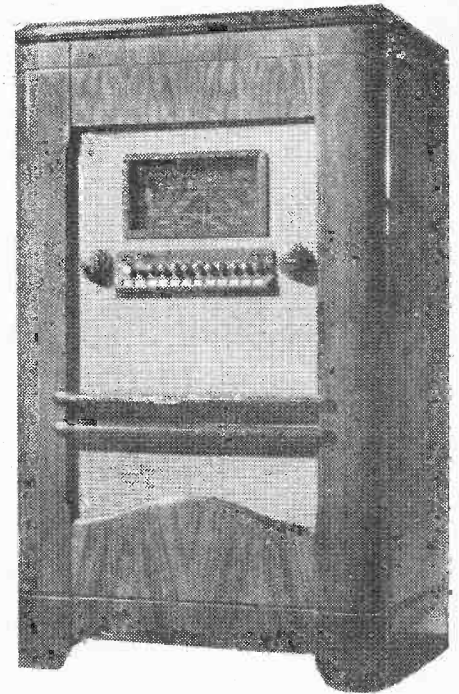

All-wave receiver with push-button tuning; H.M.V. 1500.

system, with which is also associated a duo-diode in a discriminator circuit. A duo-diode-triode provides detection, AVC and AF amplification and feeds the output tetrode. Negative feed-back is used and the output is given as 10.5 watts. The push-button tuning system is motor-driven and caters for six MW and two LW stations. AFC is provided primarily for motor tuning, but can be used or not as desired for manual tuning.

A somewhat smaller receiver, but of similar general type, is the model 1500. This has no RF stage and a smaller output valve is used. AFC is included but with a different circuit arrangement, and the push-button system is of the switch-type. There are three wavebands.

Television is also a prominent feature of this exhibit, and not the least interesting

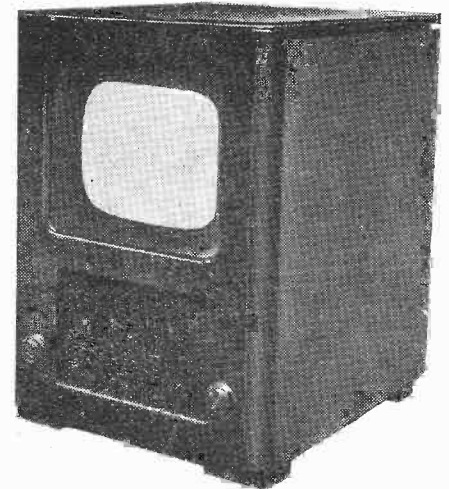

H.M.V. television receiver, Type 1800.

point in the new models is the inclusion of a noise-suppression circuit on television sound. An RF stage is used with triode-hexode frequency-changer and two IF

WHEN AT
RADIOOLYMPIA
VISIT THE

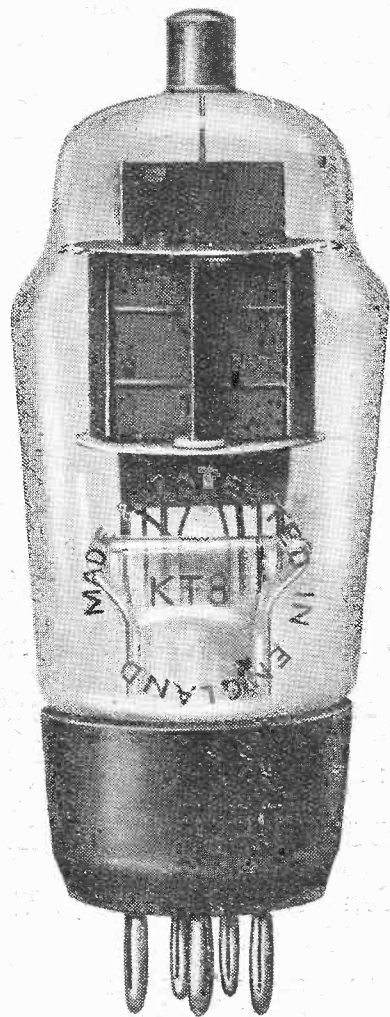

G.E.C.
STAND

and discuss any valve
problem you may have,
without any obligation.

*It will
have to be*

SCOPHONY

LARGE SCREEN TELEVISION

AS AGAINST
'SMALL' SIZE
VIEWING . . .

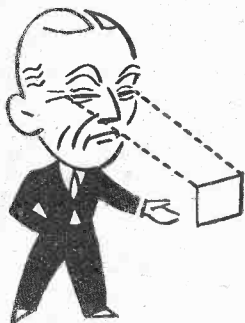

THE SCOPHONY
LARGE SCREEN



"IT'S A REAL
PLEASURE"

You would *not* use to-day a Crystal Set and ear-phones! Similarly, the future of Television is the LARGE home screen. Here Scophony are YEARS AHEAD! Only Scophony Home Television gives so high a standard of brightness on so large a screen with such simplicity. Write for details of Scophony Large-Screen Home Receivers—Screen sizes : 18 inch, TWO FOOT, and Palace de-Luxe FOUR FOOT—to Scophony Ltd., Thornwood Lodge, Campden Hill, London, W.8.

TELEVISION WITHOUT EYESTRAIN

Olympia 1939—

stages, all being common to both sound and vision channels. Vision and sound are then separated and each has a further IF stage. On sound the output of this is taken to a duo-diode detector and noise suppressor, which is followed by a triode AF stage and tetrode output valve. On vision, a diode detector is used and followed by one VF stage which feeds the magnetically deflected and focused CR tube and also a diode and tetrode used for sync separation. Hard-valve saw-tooth oscillators are used and followed by tetrode output valves. The models 1800 and 1801 have a 10in. tube, and the former, which is a table model, costs 31 guineas. The 1802 and 1850 have a 14in. tube; these are both console types, but the latter includes an all-wave broadcast set. The 1802 is listed at 44 guineas.

The Gramophone Co., Ltd., 98-108, Clerkenwell Road, E.C.

HEAYBERD (57)

Domestic and service-station type battery chargers occupy a large part of this stand. One that would be ideal for charging the small accumulators in deaf-aid amplifiers is the miniature Tom Thumb model, which will charge a 2-volt cell at 0.5 amp. The Model A.O.2 can be used for charging 2-, 4- or 6-volt batteries at one ampere, while if one requires to charge 2-, 6- and 12-volt batteries the Model A.O.3 provides the required output.

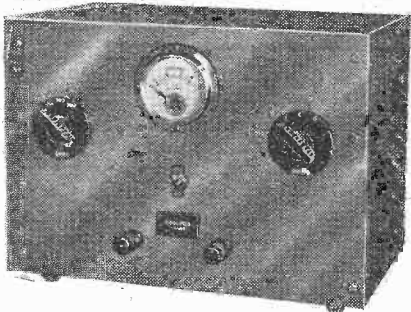

Heyberd Model A.O.9 battery charger.

Various examples of rectifying equipment for converting AC to DC are also shown, together with a representative selection of mains transformers to meet general wireless and television requirements.

F. C. Heyberd & Co., 10, Finsbury Street, E.C.2.

HOLSUN (40)

A composite display of the three well-known makes of batteries, Dagenite, Fuller and Pertrix, comprises this exhibit. Of special interest in the Dagenite range is the clock-type indicator fitted to the GBC.9 LT accumulators, while prominent in the Pertrix series are the new combined HT and LT units for use with the latest 1.5-volt valves.

Holsun Batteries, Ltd., Neville House, Page Street, S.W.1.

IMHOF (70)

With the object of reducing the time required to repaint "IM" Long Playing and other types of non-metallic needles a

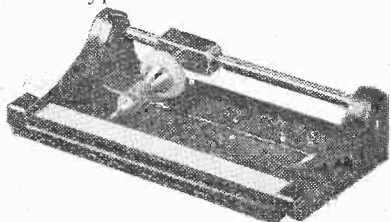

Imhof "IM Pointmaster" needle sharpener.

new sharpener, known as the "IM Pointmaster," has been developed. This is of the reciprocating type and is mounted on a black moulded base which can be screwed to the turntable motor board. The price is 3s. 6d., and replacements of the special abrasive strip cost 6d. per packet of four.

Alfred Imhof, Ltd., 112, New Oxford Street, W.C.1.

INVICTA (16)

Eight table models, three portables, a console and a radio-gramophone constitute the basis of the Invicta programme for the coming season. Those receivers with "all-wave" specifications include a short-wave band of 50-200 metres covering the trawler wavelengths, etc., and the short-wave broad-

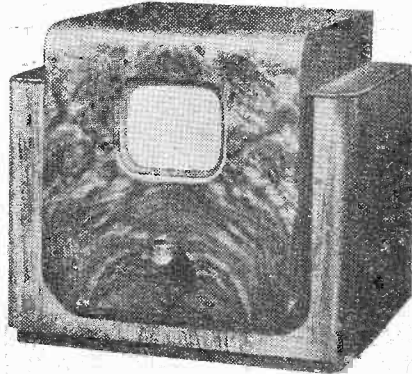

Invicta TL4 "add-on" vision unit.

cast band tunes in each case down to 13.5 metres.

The A49C console and A49RG radiogram, at £12 and 17 guineas respectively are neat instruments which should appeal to dwellers in flats and small houses. Those who want something smaller still will find the "IMP" midget receiver of special interest.

In addition to the broadcast receivers there are three television sets. Model TL7 is a console with a 9-inch tube and costs 32 guineas. There is a similar model (TL8) with a 12-inch tube, and also a unit for vision only designed for addition to an existing broadcast receiver.

Invicta Radio, Ltd., St. Andrews Road, Cambridge.

LAWLEY (83)

This firm specialise in the production of portable and emergency lighting equipment

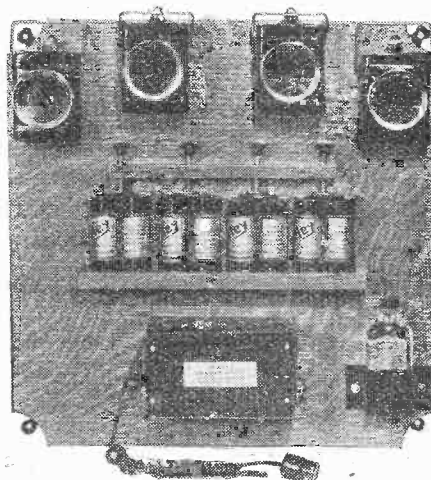

Model A.C.5 portable lighting set made by Lawley Electric.

in which a new type of dry accumulator is used.

A compact 6-volt 40-amp. hour unit, including an AC mains charger, costs

£6 ros. This is suitable for installation in caravans and private A.R.P. shelters, and it could also be used to operate a vibrator or converter-type HT supply unit for an emergency wireless receiver.

Lawley Electrical Storage Company, 27, Newton Street, High Holborn, W.C.2.

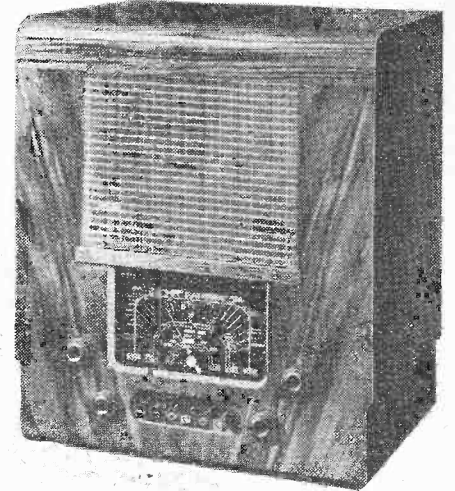

McMichael Model 393.

McMICHAEL (38)

The current list of McMichael broadcast receivers comprises eighteen models at prices ranging from 7 to 35 guineas. An undistorted output of 5 watts has been standardised in all the AC instruments with the exception of the mains transportable, and most of the models include a four-position tone control. This combines variable selectivity with controlled negative feedback, and gives a frequency response suited to every type of transmission.

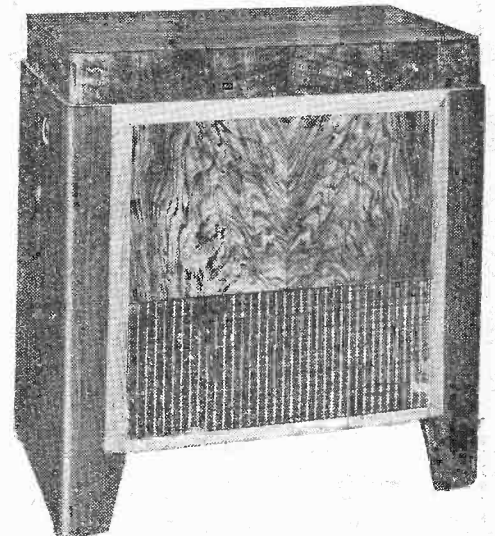

McMichael 396 radio-gramophone.

The Model 394 at £11 15s. is a typical receiver incorporating this tone control, and it is interesting to note that the same feature is to be found in the battery equivalent, Model 393, at £11 5s., less batteries.

In the Model 390, at £9 7s. 6d., will be found most of the McMichael qualities of appearance and performance at lower cost. It is a three-valve superhet with combined second detector, AVC rectifier and pentode output valve. The same chassis is used in the Model 903, which is a table radio-gramophone of remarkably compact design, selling at £14 17s. 6d.

Special attention has been given to cabinet work in all the new models, and the Model 396 radio-gramophone is typical of

Olympia 1939—

the simplicity and good taste of the latest designs.

McMichael Radio, Ltd., Wexham Road, Slough, Bucks.

McMURDO SILVER (107)

The resources of this firm are concentrated on one instrument, the "Series II" 15-17 superheterodyne, which is a 15-valve receiver of advanced design, combining the sensitivity of the "communication" type of receiver with high-quality reception from local stations. The circuit includes three IF stages with variable selectivity and a very efficient RF stage.

Refinements which have been recently introduced include a separate valve for inter-station noise suppression and negative feedback in the signal rectifier. An improved system of AF amplification with direct coupling has been developed and will be incorporated in a de luxe version of this receiver.

British McMurdo Silver Co., Ltd., 17, Hertford Street, Park Lane, W.1.

MARCONI-EKCO (109)

Laboratory type equipment, much of which will appeal to the advanced service engineer, is shown on this stand. One such is a beat frequency oscillator with a range of 10 to 12,000 c/s and giving 500 milliwatts output. Another is an ultra-short-wave signal generator which can be supplied with a frequency coverage of 5 to 60 Mc/s or 18 to 150 Mc/s. Modulation at 400 c/s is normally provided, but in a specially altered model external modulation at 2,000 c/s can be employed.

An output-power meter covering a range of 0.1 to 5,000 milliwatts, a portable mains-operated capacity bridge for capacities of 0.1 to 500 mfd., a distortion factor meter and a wave analyser comprise some of the smaller test sets shown on the stand.

For testing and developing television sets there is the Scophony Pulse Generator

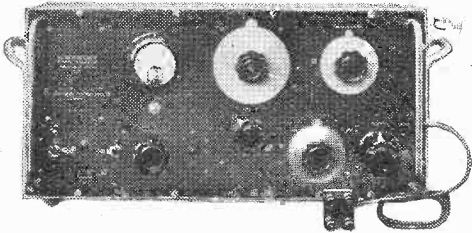

Marconi-Ekco ultra-short-wave signal generator.

which enables a receiver to be checked for interlacing, linearity, synchronisation, focusing and definition. The video signal takes the form of a lattice pattern on the screen of the CR tube, and a sound carrier modulated at 400 c/s is also generated. The combined signals are stated to be similar in all respects to those transmitted by the B.B.C.

Moving-coil headphones are made by this firm, and these give a good response over a range of 50 to 8,000 c/s. As they will handle an input of 500 milliwatts without overloading, they are particularly suitable for broadcast reception when for one reason or another headphones must be used.

Marconi-Ekco Instruments, Ltd., Electra House, Victoria Embankment, W.C.2.

MARCONIPHONE (36)

Television forms an important part of this firm's exhibit, and one of the most interesting models is the 712. This gives a picture

11½ in. by 9½ in. with direct viewing. The receiver is a superheterodyne with RF stage, frequency-changer and three IF stages; the detector is a diode, and is followed by a VF stage which feeds the CR tube and the sync separator. The early stages are common to both sound and vision, but the sound signal is picked out after the second IF stage and is provided with an IF stage of its own. A noise-suppression circuit is included with the detector, and there is a triode AF stage before the tetrode output valve. Magnetic deflection and focusing are used with hard-valve time bases. This model is listed at 44 guineas. Smaller sets with tubes down to 7 in. are also shown, and there is a large variety of television aerials.

The broadcast receivers cover a wide range, from a three-valve battery model at 8 guineas to a 10-valve autogram. at 54

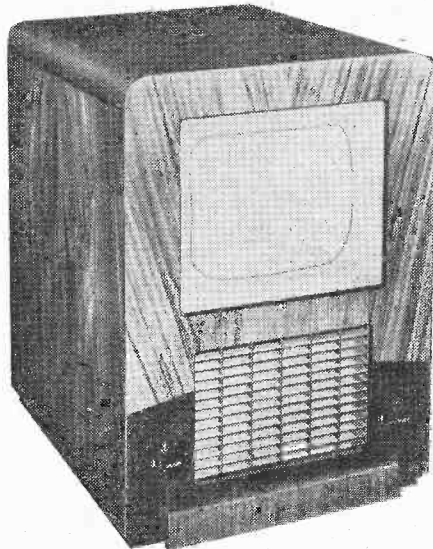

The Marconiphone Model 710 television set.

guineas. Of the new types the 884 console at 14 guineas is extremely interesting. It is a three-band superheterodyne with frequency-changer, one IF stage, duo-diode-triode detector, AVC source and AF amplifier, and tetrode output valve. Push-button tuning of the switch type is provided in addition to manual control, and gives a choice of three MW and two LW stations.

Some of the larger sets include AFC, and this is adopted for both switching and motor-driven push-button systems. In one model, the 880, AFC can also be used with manual tuning.

Marconiphone Co., Ltd., 210-212, Tottenham Court Road, W.1.

MASTERADIO (97)

The range of Vibrapacks, which are complete units for obtaining HT up to 300 volts at 100 mA from a 6- or 12-volt battery, makes an interesting exhibit on this stand. Five different models can be examined, and a feature of particular interest is the provision made in some to vary the output voltage between quite wide limits by selecting the appropriate tapings on the transformer. This is done by a switch.

The effect on the output and, incidentally, on the life of the vibrator, if components of unsuitable value are employed, is demonstrated by means of a CR oscilloscope.

Of interest is the new Type 440 high-voltage vibrator for converting DC voltages of 110 or 220 to AC at 85 c/s and with a continuous working secondary load of 150 watts.

The Masteradio range of car radio

receivers is also shown, and these include one with push-button tuning, Model 496, at 10½ guineas, and a larger 9-valve model described as the Radio-Nine at 22½ guineas.

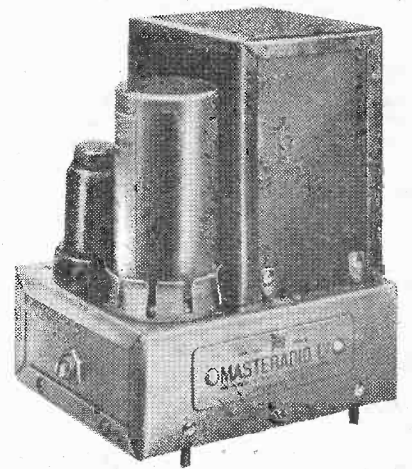

Vibrapack unit with adjustable voltage control made by Masteradio.

In most cases the receivers can be supplied with the loud speaker built in or with it as a separate unit. Various types of remote-control units are also shown.

Masteradio, Ltd., 1, Newton Street, High Holborn, W.C.2.

MULLARD (55)

Apart from valves and cathode-ray tubes this firm is showing receivers and test apparatus. Prominent among the latter is a service signal generator for which a "wobbler" is available so that it can be used in conjunction with a CR oscillograph for the visual examination of resonance curves. Two oscillographs are shown, and there is an AF oscillator as well as a capacity bridge and a valve tester. The AF oscillator is of the beat-frequency type and covers 15-15,000 c/s with direct calibration of the two dials. The output is 400 mW with less than 2 per cent. distortion.

The receivers fall into two groups: those with manual tuning and those with both press-button and manual tuning. A mech-

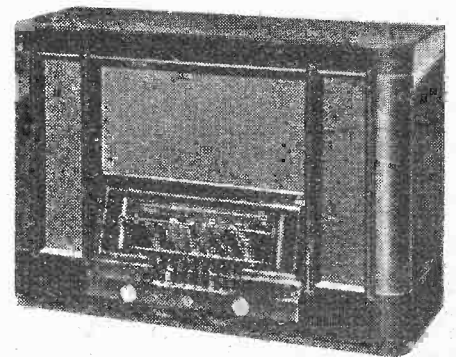

Mullard 5-valve all-wave set, MAS 103.

anical system of control is used in the latter with a very simple method of adjustment. A feature is that the press-buttons not only operate the tuning condenser but also the waveband switch. Up to six stations are available, of which three must be medium wave. The other three are available in any combination for medium and long waves as desired. A new tone control is incorporated in some models, and the negative feedback circuit is linked with the volume control so that feedback is increased as the volume is reduced.

Television receivers are also being shown. There are two models, both with gin. tubes;

Olympia 1939—

one is for television only, the other includes a broadcast set.

Mullard Wireless Service Co., Ltd., Century House, Shaftesbury Avenue, W.C.2.

MURPHY (33)

To cater for a wider range of requirements, four new television receivers have been introduced to take the place of the A56V, which was the backbone of last season's television programme. They include a table model (V84) with 9in. tube at £29, and a combined television and broadcast receiver (V88c) with 12in. tube at £50. The two intermediate models (V84c and V86c) have 9in. and 12in. tubes respectively, and are restricted to the television

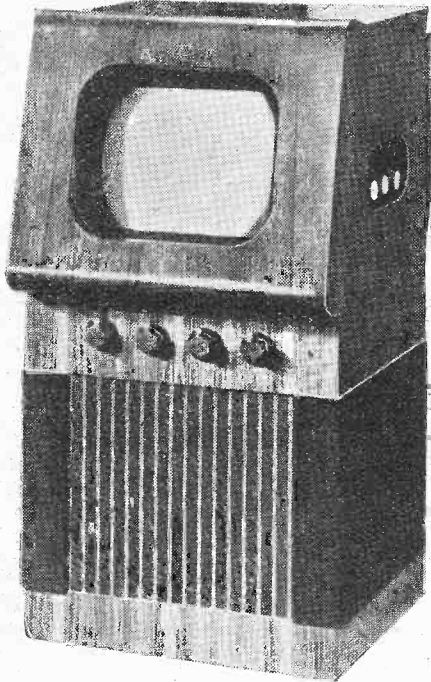

Murphy V86c.

programmes. A feature of the new models is an audio noise-suppression circuit for minimising car interference.

Two interesting new quality receivers also make their debut at the show. They are the A76c console and A78RG radio-gramophone, and may be regarded as the modern counterpart of the A40c console, which is now discontinued. Twin loud speakers are incorporated in both the new models and circuits for short-wave reception

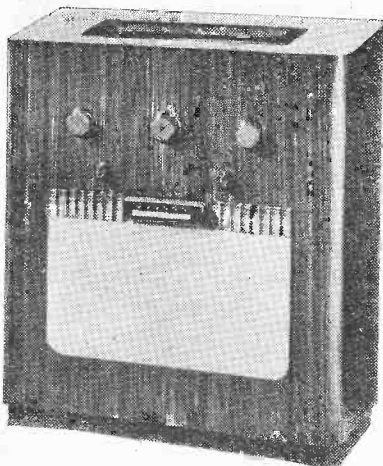

Murphy A78c.

are similar to those of the A76 table model. The latter is representative of the special

purpose receivers which are a feature of the present Murphy policy, and in it separate circuits with handsread tuning are designed to give maximum efficiency in each of the short-wave broadcast bands. Normal performance is retained in the medium and long waves.

In the Model 74, on the other hand, the emphasis is on quality of reproduction from the worthwhile medium and long wave stations.

The range is completed by the "72" series of popular receivers, and the "70" series which the makers put forward as utility receivers with the minimum specification for satisfactory results.

It is pointed out that there are virtually forty different types in the Murphy programme, for the leading models are all adaptable for push-button or remote-control which may be added at the user's discretion.

Murphy Radio, Ltd., Broadwater Road, Welwyn Garden City, Herts.

PHILCO (31)

Of the two television sets shown, one, the Model Tel. 1, is an add-on unit, sound reception being effected via the ordinary broadcast set. It includes 16 valves, gives a picture 6in. x 4½in. and costs 24 guineas. The Tel. 2 is a sound and vision set fitted with a 12in. tube. Including 22 valves, the price is 45 guineas.

There are five AC receivers, three of which embody press-button tuning systems. The Model A5 is fitted with permeability-tuned coils, push-button tuning, and provision is made for gramophone reproduction as well as for a television add-on unit. Permanent connection can be made to the television unit as internal switching makes all necessary connections to the audio amplifiers. This set has one short-wave range tuning from 16.6 to 50 metres and costs 12½ guineas.

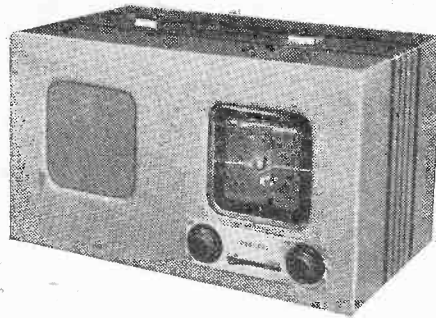

Philco all-dry battery-portable, model P429.

A similar chassis but with slight modification to the audio side is used in the Model A5 ARG radio gramophone. It is fitted with an automatic record changer accommodating 10in. and 12in. records.

There are some AC/DC models and several battery sets, one of which, the Model B2, is a four-valve all-wave superhet with push-button tuning. The latest 1.5-volt valves are fitted and dry batteries are used for both HT and LT supplies. Another all-dry battery set is the Model P429 portable which, complete, costs 9½ guineas.

Three car radio sets and a range of extension loud speakers are shown.

Philco Radio & Television Corporation of G.B., Ltd., Perivale, Greenford, Middx.

PHILIPS (45)

Five new television receivers are being shown in addition to the large-screen instrument which is being continued from last year. The basic instrument is the Type 2405 horizontal table for sound and vision

only, at 32 gns. There are two consoles giving picture sizes of 7½in. x 5½in. and 10in. x 8in. and two similar models incorporating wireless receivers with the latest Philips push-button control.

This new control mechanism is of ingenious design and is well worth a close examina-

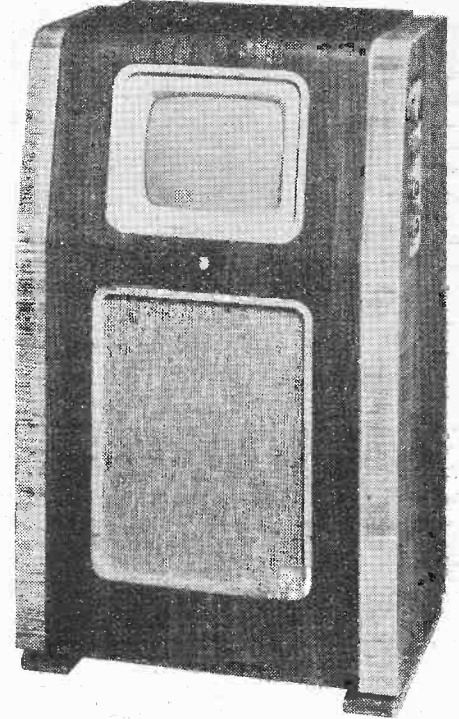

Philips Type 2407 television console.

tion. It operates spiral vaned tuning condensers, which this year have been shaped to give a straight line frequency characteristic, and the most important advantage is that the waverange is automatically selected by the station button according to the position in which it was originally adjusted. Any or all of the six keys can be allocated to medium-wave stations, and up to three for long-wave stations.

The sets which include the new tuning system are the Type 680 table model at 10 gns., Type 735 table model 3-diode rectifier at 12½ gns., Type 855 with the addition of a "Silentron" RF stage at 15 gns. and the Type 599 console and Type 711 radio-gramophone at 14 gns. and 23 gns. respectively.

Two battery receivers, a simple three-valve mains superhet, a battery portable and a car radio receiver complete the range. All the mains receivers incorporate an improved tone control system with negative feed-back designed to afford maximum amplification on weak stations.

Philips Lamps, Ltd., Century House, Shaftesbury Avenue, W.C.2.

PILOT (42)

This firm is showing a wide range of receivers, among which are two models with press-button tuning. Among the larger receivers the T.59 is interesting in that it covers 6.5-2,000 metres in five bands. It has a Class A push-pull output stage with negative feed-back and an output of 10.5 watts.

The smaller sets have only one SW band—16/53 metres—in addition to the medium and long, and a single output valve. Of this type the Model 35 is available in various forms, from a table model to a radio-gramophone at prices of 10½-21 guineas. These are AC models, but AC/DC types are available at slightly higher prices.

Olympia 1939—

Among the battery sets the Twin-Miracle is interesting, since it is arranged for all-dry battery operation or AC/DC mains operation. It covers medium and long waves

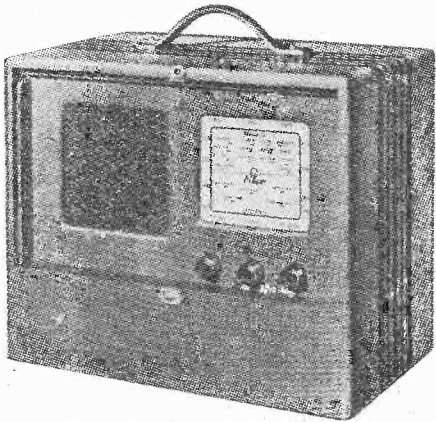

Pilot Twin-Miracle AC/DC/battery portable.

with a built-in aerial and is a portable; it is listed at 9½ guineas with batteries.

Pilot Radio, Ltd., 31-33, Park Royal Road, N.W.10.

PIX (64)

The products shown by this firm are mostly related to aerials, and in addition to components such as lightning arrestors and earthing devices, complete aerial systems are being shown. The "Gripon" aerial is designed for easy attachment to building projections such as water channels and is provided with an efficient waterproof insulator.

British Pix Co., Ltd., Pix Works, Lillieshall Road, S.W.4.

PLESSEY (68)

This stand is devoted to a display of the components, skeleton units and accessories made exclusively for wireless set manufacturers.

These include gang condensers in a variety of types and sizes, Yaxley-pattern switches, permeability tuning units, motor-drive tuning units, loud speakers and items of this kind that go to make up a modern radio set.

Plessey Co., Ltd., 56, Vicarage Lane, Ilford, Essex.

POLAR (110)

A number of new short- and ultra-short-wave condensers have been introduced this year. The Type E is now available in sizes and plate spacing particularly applicable to low- and medium-power transmitters, but none the less suitable for use in receivers as well.

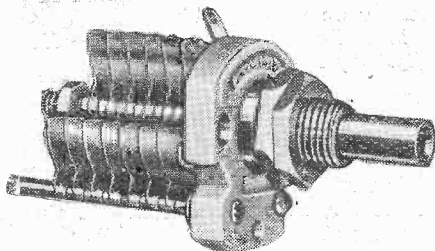

Miniature-type Polar condenser for ultra-short-wave circuits.

With normal spaced vanes eight different sizes are made, ranging from 36 mmfds. to 162 mmfds. coverage. These are known as the Type E, C602. With wider spacing they become the Type E, C603, and the eight sizes made give coverages of from 3.2 mmfds. to 28.4 mmfds. Single and two-gang models are made.

There is also a new range of ultra-short-wave miniature condensers having steel frames and brass vanes.

Polar Bar-Type two- and three-gang models are shown, together with some new short-wave condensers mounted in the same pattern frames. These have maximum capacities of 92 mmfds. and a three-gang model costs 17s. 6d.

A complete range of mechanical push-button tuner units, oak rotary switches, N.S.F. resistances, volume controls, tubular and silvered-mica condensers and special components available to set makers are also shown.

Wingrove & Rogers, Ltd., Mill Lane, Old Swan, Liverpool, 13.

PYE (32)

Among the twenty-six broadcast receivers shown by this firm, one of the most interesting is the "International." In addition to the usual medium and long ranges there are six short-wave ranges—one for each broadcast band—with band spread tuning on each range. Added together these give an effective scale length of 44ft., and it has been found possible to calibrate the settings of

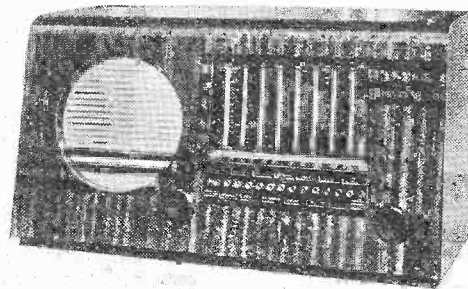

Pye "International" receiver.

individual short-wave stations. The price is 16½ guineas.

Press-button tuning is now a feature of many of the Pye transportables, and in the mains-operated models the buttons are illuminated as in the table model receivers.

Every conceivable requirement has been catered for and the models listed range from the "Mite" portable at £4 19s. 6d. to the Model PS/RG at 33 guineas.

In the new television receivers, simplicity of operation has been given first consideration. There are only two main controls, for picture brightness and sound volume. High sensitivity is provided in all models, and no additional amplification should be required near the outer edge of the television service

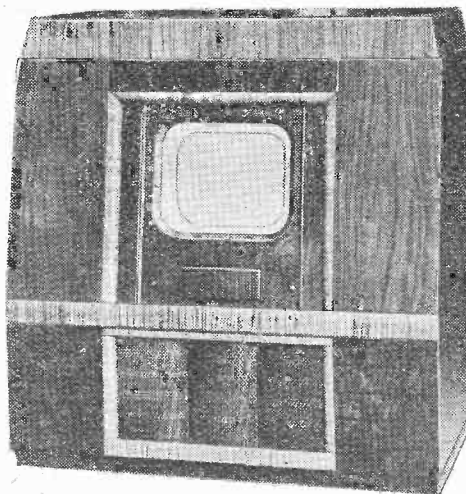

Pye 12RG combined radio-gramophone and television receiver.

area. The sound section includes noise suppression circuits for ignition interference and the sound section may be operated independently for relays of high-quality broadcast programmes. In the Models 9c and 12c the sound output is 2½ watts and in the Models 12CR and 12RG, 8 watts.

All four models are consoles, a 9-inch tube being employed in the Model 9c at 32 guineas and a 12-inch tube in the remainder. Models 12CR and 12RG include a radio chassis similar to the Model PS, and the Model 12RG, which costs 70 guineas, is equipped with an automatic record-changer.

Pye, Ltd., Radio Works, Cambridge.

R. and A. (111)

This company specialises in the supply of loud speakers to set manufacturers, and the stand includes a representative display of moving-coil reproducers with circular and elliptical diaphragms. Seven diaphragm sizes have been standardised, and both energised and permanent-magnet fields can be supplied to manufacturers' specifications according to the flux density required.

Output transformers and chokes are available in a range of seven different types.

Reproducers & Amplifiers, Ltd., Frederick Street, Wolverhampton.

R.G.D. (29)

Three basic chassis form the foundation of the 1939-40 range of broadcast receivers and radio-gramophones. A six-valve permeability tuned push-button superhet is found in table model, console and radio-gram. form at prices from 16 to 35 guineas.

Motor driven tuning is supplied in the 11-valve chassis, which is provided with a 6-watt output in the 3611 console and 5311 auto-radio-gramophone and 12 watts in

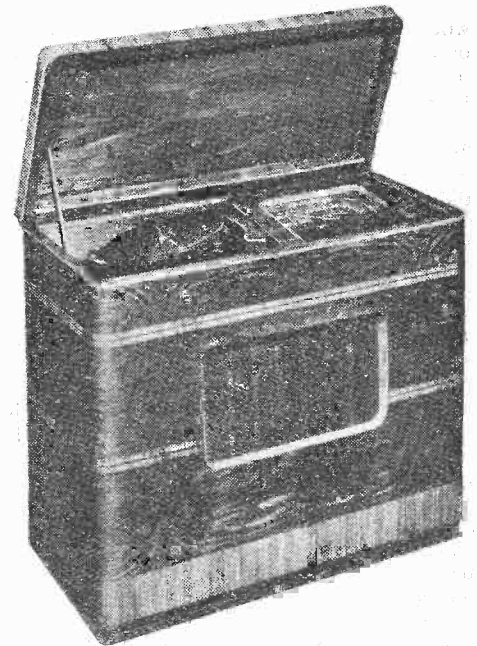

R.G.D. Model 356.

the 5511 console and 7511 auto-radio-gramophone.

The most impressive instrument of the series is the Model 1015 at 110 guineas. This has a 14-valve circuit and an output stage giving 18 watts. Bandsread tuning is provided for the 19-metre band, and the motor-driven push-button tuning system is fitted as standard, with remote control.

Two radio-gramophone models are equipped for television reception, the Model 391RG at 75 guineas and the Model 392RG, with 12in. tube, at 130 guineas. The tele-

Olympia 1939—

vision chassis is also available in a console, for sound and vision only, at 45 guineas. A gin. tube, giving a picture size of $7\frac{1}{2}$ in. \times 6in., is employed, and controls on the front panel are provided for focusing, brilliance, contrast and sound volume. The vision receiver may be switched off separately, leaving the sound channel for reception of broadcast programmes relayed through Alexandra Palace.

The cabinet work of this firm reaches a high standard, and the Model 5511, with balanced roll-top cover, and the Model 196 console may be singled out for their neat design.

Radio Gramophone Development Co., Ltd., Newton Row, Birmingham, 6.

ROLA (24)

No fewer than twenty-six distinct types are included in the range of Rola speakers now available for the retail market. The G12 high-quality unit which is normally

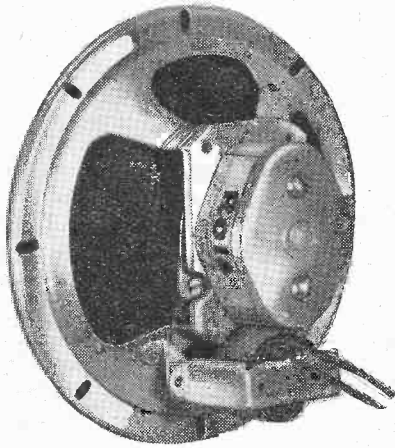

Rola Model 65-55PM.

wound to an impedance of 8 ohms may be obtained with a 15 ohms coil for PA work in both energised and permanent-magnet types.

In all the remaining models the air gaps are completely enclosed, and it is not necessary to resort to the use of cloth bags to prevent troubles arising from the ingress of dust particles. Certain PM models are fitted with an elliptical magnet of new design.

The "Roma" and "Rex" cabinet extension speakers are being continued.

British Rola, Ltd., Minerva Road, Park Royal, N.W.10.

NORMAN ROSE (12)

Servicing apparatus, a range of components including resistances, condensers, mains transformers and tuning units comprise the exhibits on this stand.

The latest Norman testing equipment is a comprehensive bridge enabling condensers from 0.00001 mfd. to 160 mfd. to be measured and tested for leakage as well as measuring resistance up to 10 megohms. Its other applications include checking and alignment of receivers, ascertaining ratio of transformers and the various tests and measurements that have to be made on sets and components by the serviceman. Known as the Model N.L.B. it costs £9 9s.

Several portable valve testing sets are shown, as well as a universal AC/DC meter.

Norman Rose (Electrical), Ltd., 43, Lamb's Conduit Street, W.C.1.

ROTHERMEL (71)

Three recently introduced products are interesting visitors to this stand. They are the new "Junior" and "Studio" crystal pick-ups and the Type BH microphone.

The latter is a neat bullet type hand microphone with a frequency range from 50 to 1,000 cycles, costing £3 15s.

The "Junior" pick-up at 19s. 6d. has a crystal cartridge of the torsion type which is housed in a die-cast tone arm of simple design and smooth exterior. In the Type S a more elaborate tone arm is provided with ball-bearing pivots and calibrated needle pressure adjustment.

A range of Centralab potentiometers is also displayed on this stand.

R. A. Rothermel, Ltd., Rothermel House, Canterbury Road, N.W.6.

SCOPHONY (49)

The television receivers produced by this firm are, of course, of a mechanical type, and in this respect are unusual. The smallest is known as the 18in. receiver, since it gives a picture 18in. by $14\frac{1}{2}$ in. The viewing screen is flat and is built into the cabinet; there are four vision controls and one sound.

The vision receiver has three RF stages before a diode detector, the output of which feeds a VF stage. The output of this is taken through a DC restoring circuit to a buffer stage modulating the RF amplifier which feeds the light control system. The buffer stage also feeds a sync separator, which is followed by line and frame pulse amplifiers.

A larger receiver is very similar, but gives a picture with a 24in. side, and then there is the Palace De Luxe Receiver. This gives

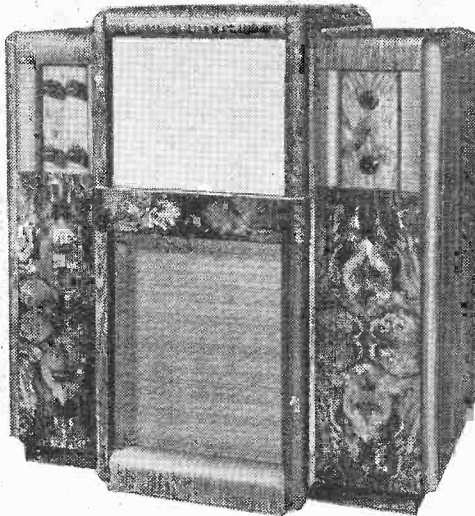

Scophony 18in. television receiver.

a picture 4ft. by 3.25ft. and is intended for use in ballrooms or small cinemas.

Scophony, Ltd., Thornwood Lodge, Campden Hill, N.W.8.

SCOTT INSULATED WIRE (103)

The display on this stand has been restricted to a single reel characterising the products of the works.

A new alloy known as "Manganamron" with electrical properties similar to manganin has been developed and wires drawn from this material are now available. Litz and other wires can be made up to customer's own specification in forty-eight hours by a new service shortly to be inaugurated.

Scott Insulated Wire Co., Ltd., Queensland Works, Westmoreland Road, N.W.9.

SERVISOL (11)

Items mainly of interest to servicemen are shown on this stand. They comprise Servisol switch-cleaning liquid, an indentation and scratch remover kit for renovating cabinets and a device for examining fine wires for structural defects.

A microphone stand having a wide range of height adjustment and a transverse current carbon microphone costing 16s. are also shown.

Servisol, Ltd., 74, Renshaw St., Liverpool.

SIEMENS (52)

The exhibit of this firm is divided into two sections—batteries and valves. In the former category a wide range of types is shown, and of especial interest are the dry batteries for HT and LT supplies; they are designed for use with the new 1.4-volt valves. These valves consume quite low currents and have been specially developed for operation from a dry battery.

They are on view, in common with other Tungfram valves, and the range includes types suitable for most purposes. Among a wide variety of valves two deserve special mention—the ELL1 and the RV200/600. The former is a double pentode for sets with a vibrator HT supply and the latter is a rectifier rated for an output of 200 mA at 600 volts or 300 mA at 250 volts.

Siemens Electric Lamps & Supplies, Ltd., 38-39, Upper Thames Street, E.C.4.

STEATITE (61)

A display of insulators and low-loss mouldings in ceramic materials is found on this stand.

A new insulator described as Frequentite "S" has been introduced for use as the dielectric in high-power ultra-short-wave transmitting condensers. Another low-power factor dielectric is Faradex. This has a negative temperature coefficient and condensers made from it can be used to compensate for frequency drift in RF circuits.

Steatite & Porcelain Products, Ltd., Stourport-on-Severn, Worcestershire.

STERLING BATTERIES (65)

This stand is devoted to a display of all kinds of HT and LT batteries, a special feature being made of dry cells for LT work. These are obtainable in units with HT supplies for the complete operation of a receiver from dry batteries. The exhibit is completed by a selection of miscellaneous types of cycle and torch batteries.

Sterling Batteries, Ltd., Sterling Works, Dagenham, Essex.

T.C.C. (63)

An interesting development in the design of wet electrolytic condensers is the new

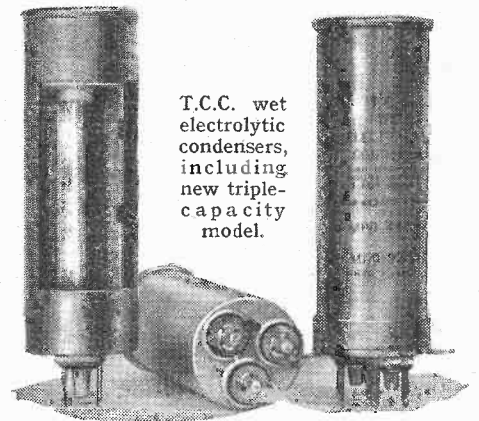

T.C.C. wet electrolytic condensers, including new triple-capacity model.

triple-capacity type which is shown this year. The case forms the common negative connections and the individual sections can be of different capacity. One model has capacities of 8-10-4, for example, with DC working voltages of 440, 350 and 440 respectively, while in another they are 8-10-8, the same working voltages applying.

In the dual pattern there are five different models.

Olympia 1939—

An air-spaced trimmer condenser constructed on an entirely new principle is shown this year. It has a straight-line capacity law and adjustment of capacity can be made accurately to within 0.1 mmfds., which order of change represents an angular movement of 6 degrees of the adjusting screw.

The base measures 1in. x 3/4in., but the height varies with the capacity. Thus, one of 35 mmfds. maximum is 3/4in. high, while one of 80 mmfds. is 1in. high. An intermediate size of 50 mmfds. is also available.

Being designed to have a small capacity variation with temperature change, these are intended for use, among other purposes, in push-button circuits where a high degree of stability is essential.

Telegraph Condenser Co., Ltd., Wales Farm Road, Acton, W.3.

TAYLOR ELECTRICAL INSTRUMENTS (101)

The servicing equipment shown on this stand comprises valve testers, a signal generator, two CR oscilloscopes and a range of measuring instruments. The signal generator covers a range of 6.5 to 3,000 metres, the ultra-high frequency range being harmonics. Internal modulation at 400 c/s or external modulation can be employed.

When used in conjunction with the Model 35 CR oscilloscope, which instrument has a 3in. tube, two amplifiers, a time base and a frequency-modulated oscillator, examination and adjustment of IF amplifiers in superhet. receivers can be effected visually.

The "Wobulator" operates at 1,000 kc/s and the band-width is adjustable between 10 and 30 kc/s.

Comprehensive test sets with seventy distinct ranges for measurement of AC and DC volts and current, resistance, capacity and inductance are also shown. Three models are made, the 80A has a resistance of 2,000 ohms per volt; the 80B, 5,000 ohms per volt DC and 4,000 ohms AC, and the 80C, 20,000 ohms per volt DC and 16,700 ohms AC. These cost £10 10s., £12 12s. and

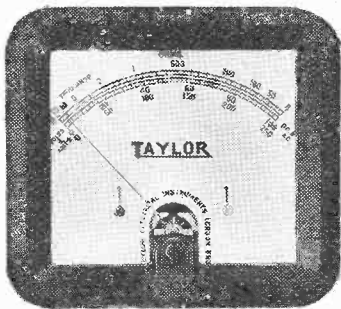

Taylor Model 425 universal AC/DC test meter.

£14 14s. each respectively, and they are assembled in oak cases with detachable lids.

Taylor Electrical Instruments, Ltd., 45, Fouberts Place, Regent Street, W.1.

TELCON (22)

A complete service to cable engineers is offered by this firm. In addition to many new high-frequency cables for trunk television lines, aerial feeds, etc., accessories such as "Telcon" moisture-resisting plastic tape and compound, adhesive screening foil are being shown.

Another branch of the firm's activities is concerned with magnetic alloys, and "Rhometal" is being widely used for the cores of television line-scanning transformers. "Mumetal," in addition to its application in small audio-frequency trans-

former cores, is employed for screening purposes and is effective in 50-cycle AC fields.

Telegraph Construction & Maintenance Co., Ltd., 22, Old Broad Street, E.C.2.

ULTRA (43)

The needs of the country listener have not been neglected in framing the Ultra programme for the coming season, and among the many battery receivers the Model 308 may be noted on account of the fact that press-button tuning is included. The price is 9 guineas, excluding batteries.

The Model 315 all-wave superhet, for AC mains, is housed in a cabinet of striking design, and has press-button selection for six stations, waverange and gramophone reproduction. The price is 12 guineas and a radio-gramophone version costs 22 guineas.

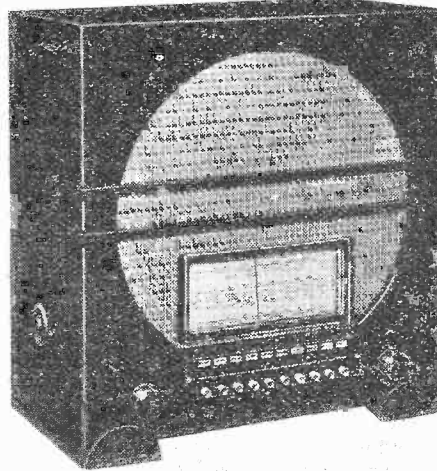

Ultra Model 315.

The basic television receiver in the Ultra range is the Model T50, at 29 guineas. It is housed in a horizontal table cabinet and employs a 9 inch tube. In the Model T52, at 31 guineas, a walnut stand is provided, and in the Model T54, at 42 guineas, an all-wave receiver similar to the Ultra 309 is neatly incorporated in the base.

Ultra Electric, Ltd., Western Avenue, Acton, W.3.

VARLEY (108)

Among the many components made by this firm is a permeability-tuned IF transformer for 465 kc/s. One advantage claimed for this method of IF trimming is that good stability is obtained, but in addition the construction is such that as only a limited inductance variation has to be allowed the IF amplifier is so closely tuned to the correct frequency that final adjustments are quite easily effected.

There is also a range of condenser-trimmed IF transformers for both 465 kc/s and 110 kc/s, as well as the current range of Nicore and Duo-Nicore coil units and coils.

Other items of interest comprise AF and mains transformers, thermal delay switches, smoothing chokes, power potentiometers and resistances.

Varley, Cambridge Row, Burrage Road, S.E.18.

VIDOR (51)

The "Good Companion" superhet. portable with QPP output stage is being continued, and is now supplemented by the Model 320 "all-battery" portable. This is a four-valve straight receiver with 1.4 volt valves running entirely from dry cells. The price, complete with batteries, is 6 guineas.

Two table-model receivers complete the Vidor range. The Model 323 for AC mains has six valves, including the cathode-ray

tuning indicator, and costs 9 guineas. It tunes down to 13.5 metres and has four wavebands. In its battery counterpart—the Model 322 at 8 guineas, excluding batteries—

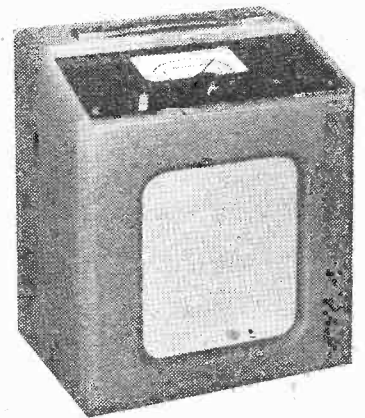

Vidor all-battery portable.

the lowest wavelength is 16 metres and the output is 1 watt from a push-pull pentode output stage.

Vidor, Ltd., West Street, Erith, Kent.

WEARITE (102)

An improvement has been made in the ganged Permeability-Tuner and adjustment of the iron cores can now be effected without the special tool needed hitherto.

Another version of this tuner is also available which provides five preselected stations—two long wave and three medium wave—and three ranges of manual tuning. There are eight press buttons, and the required manual-tuned range, which can be medium, long or short wave, for example, is selected by a push button.

The now well-known "P" coils, a range of 465 kc/s IF transformers, low-capacity

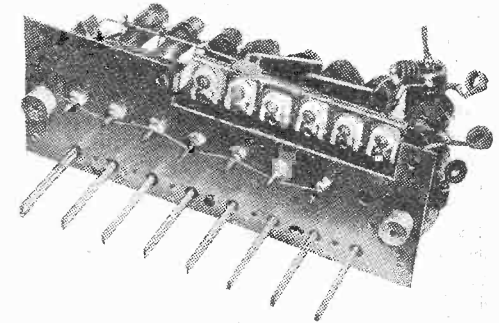

Wearite latest permeability push-button tuning unit.

lever switches and ceramic-plate switches, mains transformers and smoothing chokes are also included.

Wright & Weaire, Ltd., 740, High Road, Tottenham, N.17.

WESTINGHOUSE (30)

The metal rectifier units shown on this stand indicate the wide range of their application in broadcast reception, television and telecommunications. Types represented include special rectifiers for HT supply to cathode-ray tubes, loud speaker field supplies and "Westectors" for signal rectification, AVC and battery economising circuits.

A section of the exhibit is devoted to battery charging, and the Model RGC10 multi-circuit charger is being shown under working conditions to demonstrate its flexibility and ease of operation.

Westinghouse Brake & Signal Co., Ltd., 82, York Way, King's Cross, N.1.

Letters to the Editor

Reproduction Levels

I AM quite distressed; nay, I am seriously perturbed. I always thought that my reproduction quality at home was above the average. Now I read that my quality cannot possibly be good, which implies that the results of all my home experiments are worthless, and, in addition, I must leave my flat with the comfortable 11ft x 13ft. room in which I do most of my listening. All because someone has stated (*The Wireless World*, August 10th, 1939, page 136): "We can at least all agree that these small flat-dwellers form an unlucky group to whom high-fidelity radio is an impossibility."

Anyone who has tried to telephone from the orchestra pit while the orchestra is working knows the undistorted sound from the nearer instruments is so overwhelming that he can barely hear himself speak. In the theatre the volume level is much more normal, while in the bar (doors open) the sound may be vanishingly faint.

Reproduction is possible at any volume level, and a faithful replica of the sound anywhere between these extremes of loudness can be high fidelity. Faking the volume control so as to boost the bass at low-volume levels is, therefore, inadmissible from a quality point of view.

This refers to "scale diminution." When we consider "scale enlargement," high fidelity ceases, and the ear hears extra bass, most objectionable on speech. I think it is then legitimate to cut some of this so as to obtain a less unreal effect.

The reason why the "faked" volume control became popular is, I believe, due to two causes:—

(a) At high-volume levels, owing to aural compression of the bass loudness contours, a loss of, say, 12 db. at 40 c/s is not very noticeable. As the volume level is reduced, however, these contours open out, and such a loss becomes most noticeable, particularly as the ear loss is in the same direction.

(b) It is exceedingly difficult to radiate low frequencies such as 40 c/s efficiently. Nearly all loud speakers will generate a sound when fed with 40 c/s current, but it is surprising how much energy of 80 c/s or higher this may contain. Such harmonics are normally a non-linear function of the diaphragm amplitude, and they become negligible at very small inputs. Thus, as the volume is reduced, this pseudo-bass ceases to be generated.

A faked volume control helps in either case to prevent the fault from showing up excessively as the knob is turned.

Using a loud speaker relatively free from bass loss or harmonic generation, I have often demonstrated that, even when the volume level is very low, bass is still present in natural proportion.

While I dislike the faked volume control, I do not condemn normal correction circuits. In fact, I have used such circuits ever since I became seriously interested in quality. When characteristics are known, compensating circuits can be evolved intelligently. When they are unknown, however, as with certain records and some B.B.C. transmissions, then a variable adjustment is often of immense value.

In the description of the American Pacent tone-compensated receiver it is pointed out

The Editor does not necessarily endorse the opinions of his correspondents

that, with full compensation, a 50 c/s note will require 10 watts, and "this is a good setting for the average living-room." This brings me back to the object of this letter, i.e., neighbour annoyance when living in a flat. If 10 watts is really needed for bass, either the American idea of what is correct is hopelessly exaggerated, or their speakers are very inefficient. Less than 1 watt is all that I require.

In the case of loud speakers whose average efficiency is low, it is always possible—in fact, it nearly always happens—that small factors cause quite considerable local resonances.

Now, an ordinary wall stops high-frequency sound quite effectively. It is the low frequencies which are the trouble, particularly if they are *sustained and coincide with the panel resonance of the wall*. If, now, the loud speaker, or any other part of the chain (*including microphone and studio*) has a resonance which coincides with the wall resonance, then the sound is almost certain to penetrate. If, however, all bass resonances can be rendered innocuous, then it is possible to work at a much higher average volume level without disturbing anyone.

I hope that, after these remarks, I may continue to live in a flat with my conscience clear and an equipment which, being practically non-resonant in the bass, may be operated at a volume level which (while varying with the type of programme) pleases me and does not annoy the neighbours.

P. G. A. H. VOIGT.

London, S.E.19.

"In Praise of Television" Comparison with the Cinema

IN your Correspondence column, August 10th issue, "Cathode Ray" enquires for information on the relative definition of 405-line television and standard film. Some years ago, when I was experimenting with sound-on-film, high-frequency definition was limited by the grain of the film, which I then estimated at 0.00025in. I believe film grain size has been much reduced since then—I think colour film has no grain whatever. At any rate, if the grain size is still 0.00025in., or 4,000 per inch, and taking the standard 35-mm. film with a frame height of $\frac{3}{4}$ in., it seems that comparable definition in television would require 3,000 lines. Taking into account the slightly higher frame frequency of television (25 pictures per sec. against 24 per sec. for film), it would appear that an equivalent "effective" definition in motion would require 2,880 lines for television. I think television would then be superior to film owing to the better registration of succeeding pictures.

Having sat through some hours of television programmes (in London), it seems to me that the inferior definition grows on one. The newcomer to television notices the poorer definition immediately, but the habitué gets hardened to it, and soon convinces himself it's as good as the cinema (or better). The fact is, the eye is very accommodating, and "eye memory" is bad. Visual comparisons such as colour, in-

tensity of illumination, etc., are impossible unless the comparison is made simultaneously. If the experiment were tried, by projecting a 35 mm. film on a screen *the same size* as, and alongside, the television screen, I am convinced the superiority of the film would be startling. Even a poor 9 mm. amateur film looks wonderful when projected post-card size. (In small amateur film, grain size is relatively much more coarse.)

Print is a good test of definition. I have not seen on a television screen anything to compare with the small print which can actually be read at the bottom of film titles (such as "Western Electric Noiseless Recording").

FREDK. GRISLEY, B.Sc.

Leigh-on-Sea, Essex.

HENRY FARRAD'S SOLUTION

(See page 167)

THE main symptom appears to be that reception of Bournemouth and Clevedon is up to the local standard, but all other stations are more or less badly below it. This seems to rule out IF and AF faults, and concentrates attention on the pre-selector, which in a three-valve superhet. is almost bound to consist of one or more tuning circuits and no valve, followed by a frequency changer giving an IF of probably 460 kc/s or thereabouts.

It is significant that both Bournemouth's and Clevedon's frequency is 1,474 kc/s (203.5 metres)—practically at zero capacity of the tuning condenser. If the aerial tuning section of the condenser were disconnected, nobody would be much the wiser. But at other settings of the tuning control the pre-selection is more or less non-existent, and loss of sensitivity results, together with liability to interference. In particular, as the aerial circuit is approximately tuned to Clevedon throughout the medium wave-band, one would expect this station to be strongly received on the second channel. Assuming the IF to be 460 kc/s, this second channel is 1,474 - (2 x 460), or 554 kc/s. As the frequency of Beromünster is 556, the strong whistle at this tuning point is explainable on the above theory. And as no long-wave station of any importance comes in at minimum tuning capacity, the bad results on this band are also quite consistent.

So Henry Farrad has ample reason for suggesting that a dry joint or other disconnection to the aerial tuning stator of the variable condenser is the cause of the trouble and that the performance will be quite satisfactory when this has been attended to.

Radio Interference Suppression, by G. W. Ingram, B.Sc. Pp. 154 + viii. Published by "The Electrical Review," Dorset House, Stamford Street, London, S.E.1.

In this book the author discusses the nature of electrical interference and goes on to deal with the design of suppressors. Their application to all classes of apparatus is then treated, and this occupies the greater part of the book, which concludes with tables and appendices. The field surveyed is very large, and the book is intended to "serve as the bridge between the heavy- and light-current branches of the electrical engineering art."

The Wireless World

Pre-set Quality Receiver

Continued from page 144
of last week's issue.

IN this article constructional details are given on the new receiver together with notes on its adjustment. Up to six stations are available, including Television Sound, and the apparatus is designed throughout for the highest quality.

CONSTRUCTION AND ADJUSTMENT

A MODERN receiver involves little constructional work beyond the wiring, for it consists chiefly of the assembly of the components, and the chassis is available ready drilled. In the case of the Pre-set Quality Receiver the ultra-short-wave coils are not standard components and full constructional details are consequently given in the drawing below. It is not essential to make them oneself, however, for they will doubtless be available commercially.

The mounting of the coil switches should be done carefully, for if a mistake is made it will prove troublesome to rectify

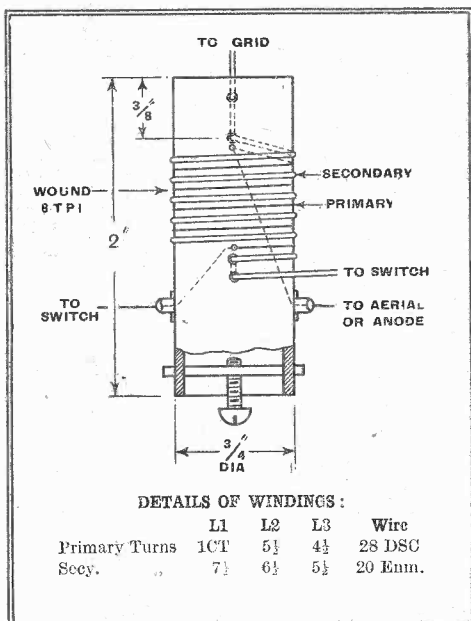

This drawing gives constructional details of the ultra-short-wave coils.

it at a later stage of the construction. There are six switch plates, of which three are single pole and three double pole. One plate of each kind is fitted in each of the three compartments. In every case the single-pole plate is used for the primary

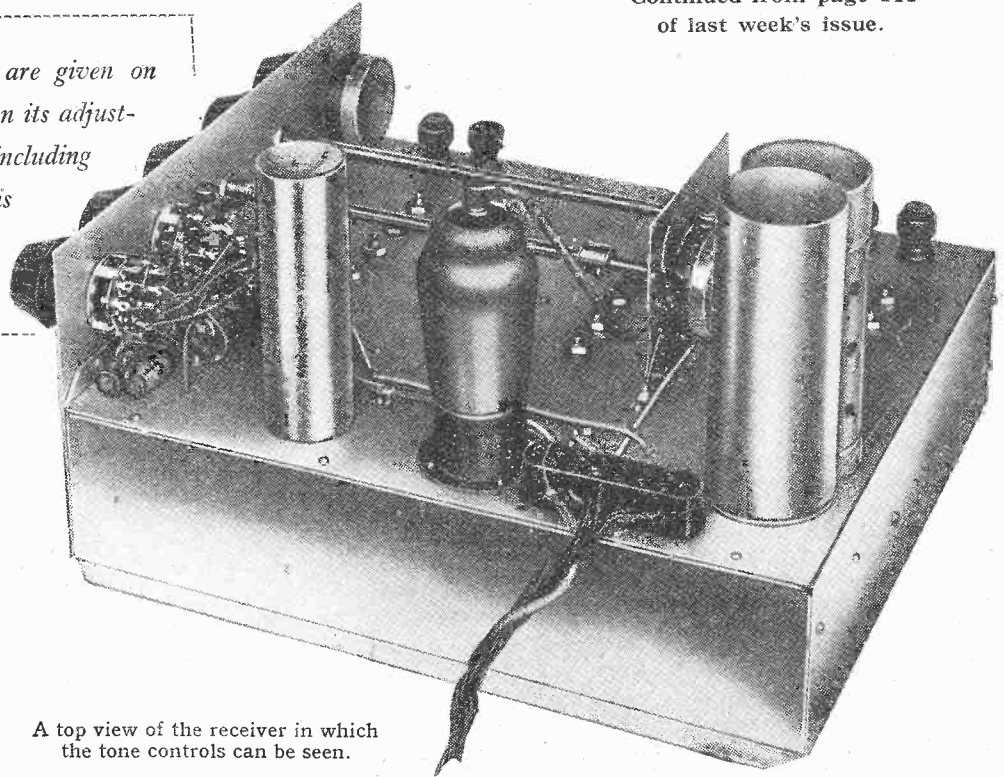

A top view of the receiver in which the tone controls can be seen.

coil connections, and the double-pole plate for the secondary and the condensers.

All plates must be assembled the same way round and so that the locator permits the correct rotation. Before mounting the plates, check that none of them have earthing plates and check that the double-pole plates have the two poles insulated. This warning is given because this type of switch is provided with earthing plates as often as not, and sometimes the double-pole type has common moving arms. If by any accident the wrong plates are used, naturally the receiver will not work properly.

In the case of the tone-control switches, the identification of the contacts may prove a little troublesome at first. The easiest and most certain way of doing this is by means of a continuity test between the contacts. When one pair has been identified correctly the others follow at once from the drawings which will appear in next week's issue.

The medium- and long-wave coils each have a long pair of solder tags and a short pair. The long pair are for the tuned winding and the short ones for the primary. On the medium waveband the long tag connected to the end of the winding remote from the primary is the grid connection. When this is identified the other connections follow from the drawings. On long waves it does not matter which way round the tuned coil is connected.

It will have been noticed that in the circuit diagram of the receiver, which ap-

peared last week, alternative connections are shown for the ultra-short-wave aerial coil. The secondary is always connected the same, but the primary depends on whether an ordinary aerial or a dipole is used. The primary consists of a single turn centre-tapped. With a dipole, the two ends of the winding are connected to the two aerial terminals and thence to the aerial via the feeder. The centre tap is connected to the medium-wave coil.

The Aerial

With an ordinary aerial the centre tap is not used. One end of the primary coil is connected to one aerial terminal, the other of which is not used, and the other end of the winding is joined to the medium wave coil.

The dipole aerial is to be recommended at considerable distances from the Alexandra Palace, since it is much more efficient on ultra-short waves. The dipole itself, however, will not give much pick-up on medium and long waves, and here the feeder is relied on. The erection of a dipole for this receiver consequently follows rather different practice from usual. The best course is to treat the feeder just as if it were an ordinary aerial wire, for in medium and long waves it acts in this way.

For the best results erect an ordinary inverted-L aerial, using the twin feeder instead of plain wire, and then put the ultra-short-wave dipole at the far end of

The Wireless World Pre-set Quality Receiver— the horizontal span. This arrangement will work as a normal dipole and feeder on ultra-short waves and as an ordinary inverted-L aerial on medium and long waves. Suitable feeder cable is obtainable from Belling and Lee with an impedance suitable for matching to the centre of a dipole—some 70-80 ohms.

This aerial system gives the maximum efficiency on all wavebands, but it is not always suitable. At short distances from Alexandra Palace the ultra-short-wave signal may be too strong and lead to cross-modulation on weaker signals on the other bands. In this case a dipole is not advised, and an ordinary inverted-L aerial is better.

Balancing the Amplifier

In a borderline case, the best course is to connect up the receiver for an ordinary aerial and try it out. If signal strength on Television Sound proves inadequate, alter the receiver connections and erect the special dipole system described above.

The initial adjustments to the receiver comprise setting the condensers for the required stations and balancing the AF amplifier. The output stage requires a load impedance of 6,400 ohms, so that the output transformer must be chosen to suit; with a 15-ohm speech coil a ratio of 20.6:1 is correct.

For balancing, a single frequency input is advisable. A constant frequency record and pick-up can be used or an AF oscillator connected to the pick-up terminals; a third alternative is to use a tuning signal such as that which precedes the programme on Television Sound. A moderate signal only should be used.

The amplifier is best balanced by inserting a 50-ohm resistance in the lead to the output transformer primary centre-tap, and connecting a pair of phones across it. It is advisable to join condensers in the phone leads, since the resistance is some 350 volts above earth potential. Short-circuit the transformer secondary, and adjust R7 for minimum signal in the phones.

With a single frequency input and only a moderate signal, a sharp null point should be obtained. With too large a signal there will be no silent point, but the balance point can still be detected because the fundamental disappears and leaves the second harmonic.

Initial Adjustment

An alternative method of arranging the output connections for balancing is to join the anode leads of the valves together and to one end of the transformer primary. Balancing is then done for minimum output from the speaker. This method is not as good since it does not show up any defect in the output transformer.

Turning now to the tuning, the ultra-short-wave adjustments must be made first, since they affect the settings of all other trimmers. Set the station selector for ultra-short waves and tune in Television Sound, using the three trimmers C1, C7, and C13, as the three tuning controls of an ungang set. When satisfied with

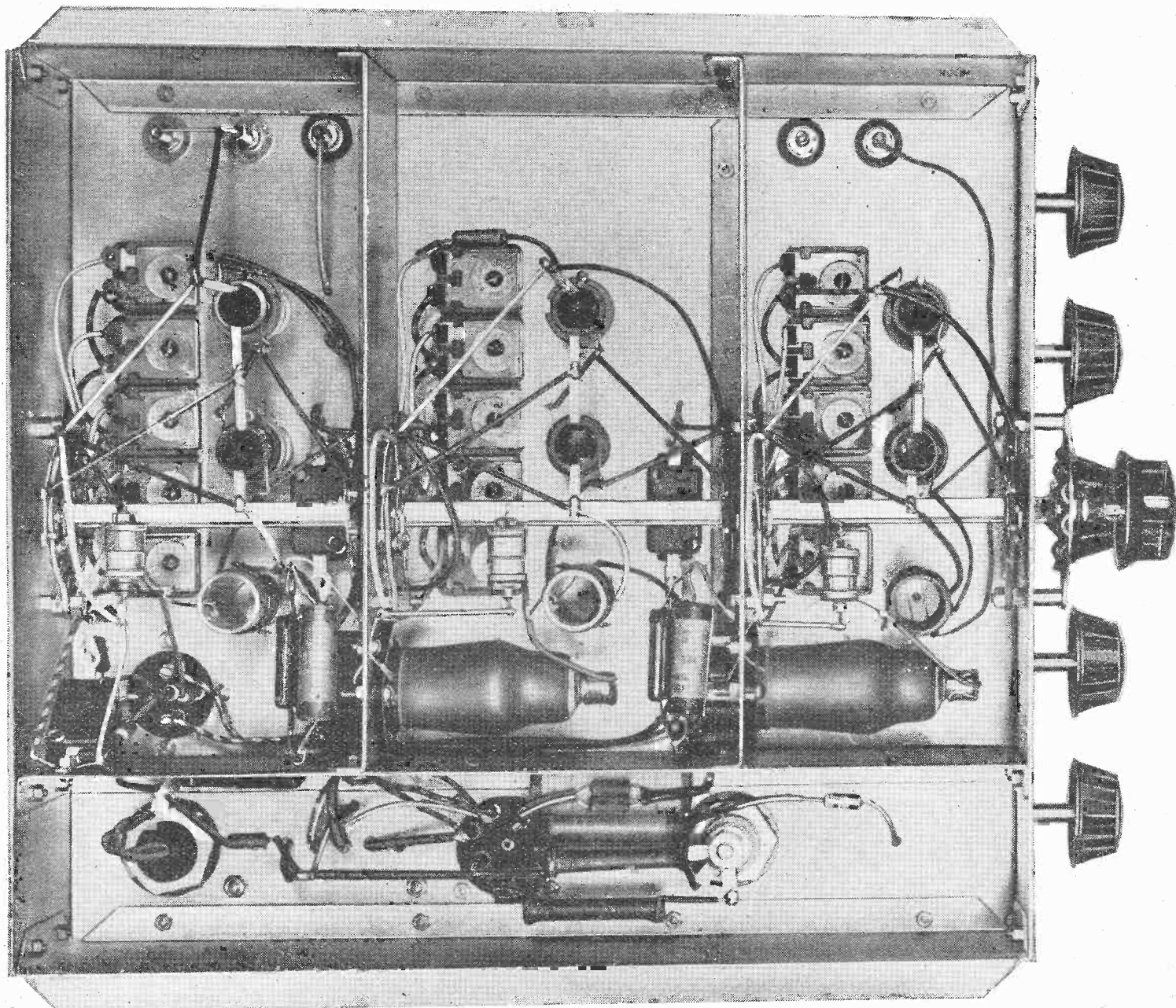

This underview of the receiver shows the RF valves mounted horizontally. This is done in order to secure very short leads on ultra-short waves.

The Wireless World Pre-set Quality Receiver— the adjustments, and not before, go on to the other bands and tune in the various stations wanted. For every setting of the switch there are three trimmers, which must be handled just like ordinary tuning controls. It does not matter in which order the various trimmers are tackled, because they are all independent of any other except Television Sound. Range 2 is intended for a station towards the lower end of the medium waveband, range 3 for one towards the middle, and range 4 for one towards the top end of the band. Ranges 5 and 6 are for the lower and upper ends of the long waveband. Good overlap is provided, however, and in the tests the receiver was set up as follows: Range 1, Television Sound; 2, London National; 3, London Regional; 4, North Regional; 5, Droitwich; 6, Radio Paris.

Performance

Having tuned in the signals, leave the detector trimmers alone and then mistune the others slightly in opposite directions to broaden the band-width. The amount of mistuning will depend on interference conditions, signal strength, and aerial efficiency, and its effect on quality will be most noticeable on long waves. If there is little interference, the output on the different stations can be roughly equalised so that little, if any, change in volume

control settings will be needed when changing from one station to another. No

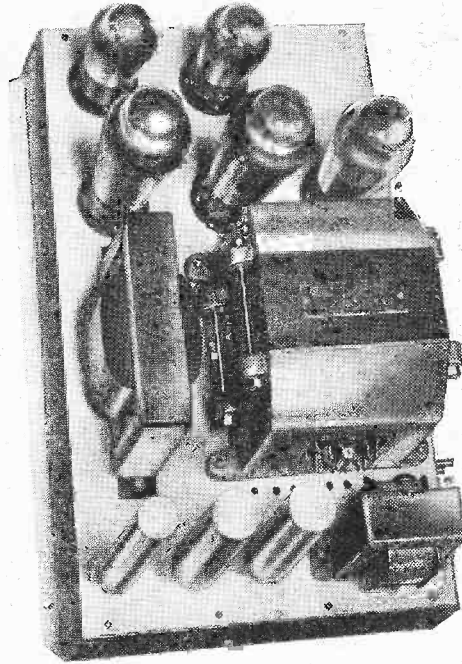

The layout of the power unit is clearly shown in this photograph.

mistuning is necessary on ultra-short waves.

In the tests, Television Sound was

tuned in to resonance, and London National, Regional, and Droitwich were mistuned to give approximately the same output. North Regional and Radio-Paris were resonance tuned, since neither signal strength nor interference permitted much mistuning. It was then found that no change in the gain control setting was needed when passing from one local to another (four in all), but that the gain had to be increased for the two more distant stations.

The quality of reproduction reached a very high standard, and mains hum was found to be inaudible. The sensitivity and selectivity proved entirely adequate for the purposes for which the receiver is intended, and the method of control proved particularly convenient. The tone controls were found very useful, and it is interesting to note that in general they were kept set for some bass accentuation and a flat treble response.

Large diagrams giving assembly dimensions and all the wiring connections for the two units of this receiver will be included in next week's issue.

A Receiver built to the design described in these articles is to be seen on "The Wireless World" Stand (No. 6) at the Olympia Show.

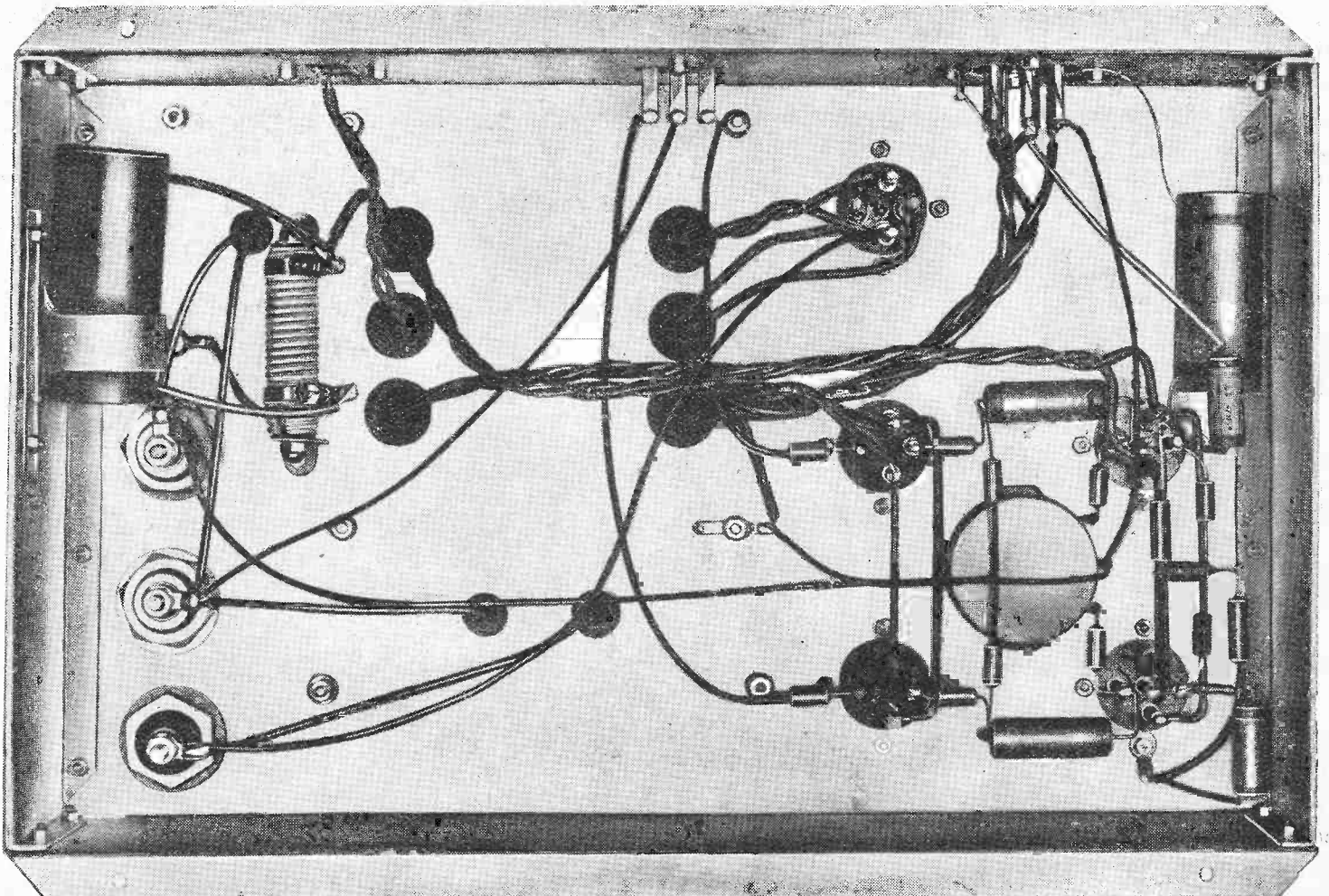

This photograph gives full details of the construction and wiring of the power unit.

Erie Resistor Ltd.

request the pleasure of your company at STAND NO. 13 RADIOLYMPIA where they will be pleased to show you many items of technical interest.

We look forward to seeing you at Radiolympia because there are a number of interesting items on our Stand which will give us pleasure to discuss with you. For those who cannot go to the Exhibition, here are a few words about our products.

ERIE Insulated RESISTORS

Guaranteed to carry 50% overload with less than 4% maximum resistance change. They give uniformly superior results in all standard tests for load, temperature, voltage, humidity and noise—compact and safe—cannot short or earth even in the smallest installation spaces. The strong Ceramic Insulating Tube will withstand 3,000 volts A.C. Every Erie Resistor is individually hand-tested.

CARBON RESISTORS		(10 ohms to 5 megohms)
RMA9.	1/2 watt ± 10%.	Insulated ... 3d. each
RMA8.	1 watt ± 10%.	Insulated ... 6d. each
RMA2.	2 watt ± 10%.	Non-insulated ... 1/- each
RMA1.	3 watt ± 10%.	Non-insulated ... 1/6 each
RMA0.	5 watt ± 10%.	Non-insulated ... 2/6 each

Specified by "The Wireless World" for the Pre-set Quality Receiver described in this issue; for the Magnetic Television Receiver and many others.

For Dealers and Service Engineers

ERIE RESISTOR KITS

For efficiency and economy you should have your resistor stock in handy cabinet form. No losses—No waste—Easy to find. We give you the cabinet. You pay only for the resistors, which are an assortment of the most used values.

All these Resistors are RMA Colour Coded. Tolerance + or - 10%.

- KIT I R 48. 48 One-Watt Resistors. List price 24/- in FREE Pressed-steel box.
- KIT I R 96. 96 Half-Watt Resistors. List price 24/- in FREE Pressed-steel box.
- KIT I R 100. 100 One-Watt Resistors. List price 50/- in FREE Strong board Cabinet, 8 partitioned drawers.
- KIT J R 200. 200 Half-Watt Resistors. List price 50/- in FREE Strong board Cabinet, 8 partitioned drawers. Subject to usual Trade Discount.

TONE & VOLUME CONTROLS

ERIE Type "M" (with 2 1/2" duralumin spindle)

The duralumin spindle can be grooved, split or drilled to any required specification and can be cut to any required length within two or three minutes, thus enabling you to save time and money often wasted in procuring special replacements.

Less Switch	... 2/6 each
With Single-Pole Switch	... 3/- each
With Double-Pole Switch	... 3/6 each
Centre Tapped with Switch	... 4/6 each
Non-standard spindles	6d. per control extra.

DUAL & GANGED CONTROLS

(Including special replacements)

Less Switch	... 4/6 each
With Single-Pole Switch	... 5/- each
With Double-Pole Switch	... 5/6 each

The range of ERIE PRODUCTS includes:

Volume Controls, Tone Controls, Vitreous Wire-wound Power Resistors, Ceramicons-Midjet Fixed Condensers, Silver Mica Condensers, Car Radio Suppressors, High Voltage Resistors.

Send to-day for full details

ERIE RESISTOR LTD.
CARLISLE RD., THE HYDE, HENDON, N.W.9

Telephone: Colindale 8011.

FACTORIES: LONDON, ENG.; TORONTO, CAN.; ERIE, PA.

TRADE COUPON

To Erie Resistor Ltd., Carlisle Road, Hendon, N.W.9.

Please send details of your RESISTOR KITS, CONTROLS, SUPPRESSORS, etc., and trade terms.

ATTACH THIS TO YOUR BUSINESS CARD.

W 24/8

TROPHY COMMUNICATION RECEIVERS



"TROPHY" is undoubtedly the foremost name nowadays in short-wave receiver discussions. TROPHY has certainly made a name for itself in high performance. "GET A TROPHY—NOW" is good advice if you want a set—at a saving—for reliable all-world short-wave reception. Listening in on the high-frequency bands with a TROPHY is recommended and thrilling radio entertainment. There's a model to suit you.

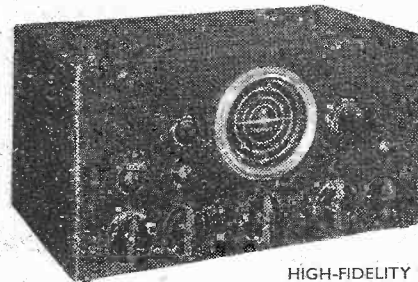

TROPHY 8. AC communication type receiver giving a very fine performance. Principal features: 8 Valves, 5 Bands, 7 to 550 metres, RF on all Bands, continuous bandspread tuning, separate Oscillator, switchable BFO and AVC, Pitch control, Doublet or Single-wire inputs, Send-Receive switch, speaker and 'phone sockets. AC mains 200/250 V. TERMS: 15/6 deposit and 18 monthly payments of 15/6. **12 GNS.**

HIGH-FIDELITY SPEAKER in cabinet to match, 2 Gns. extra

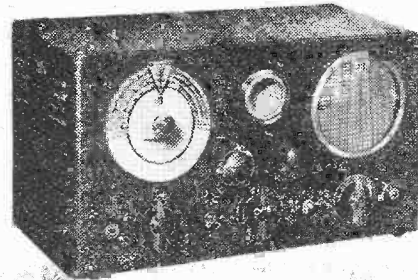

TROPHY 6. Junior AC communications with all essential tuning refinements. 6 valves, international octal types, 6.5 to 545 metres continuous, separate dial electrical bandspreading, directly calibrated frequency scale, pitch control, AVC and BFO switches, stand-by switch, inputs for single-wire and doublet aerials, built-in speaker and 'phone jack fitted. For AC 200/250 V. Cash. **9 1/2 GNS.** TERMS: 12/6 deposit and 18 monthly payments of 12/3.

Go along to your Dealer and find out more about popular TROPHY Receivers. TROPHY 12 MONTHS' GUARANTEE includes valves.

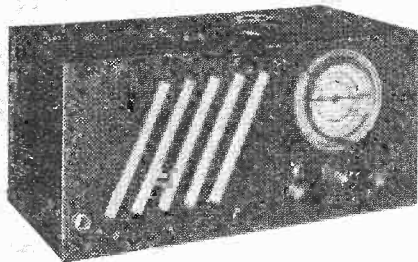

TROPHY 3. Regenerative three-valvers. Unrivalled for reliable short-wave results and dependability. Wave-range 6.2 to 550 metres. Self-locating coils for external insertion. Metre and band calibrated scale. Epicyclic slow-motion tuning. Built-in m/c speaker and 'phone jack. A.C. and Battery Models.

"No doubt about its ability to pull them in," states "Wireless World."

BATTERY MODEL: **£5 15s.**

TERMS: 7/- deposit and 18 monthly payments of 7/-.

AC MAINS MODEL: **£6. 6s.** TERMS: 7/6 deposit and 18 monthly payments of 7/9.

Supplied with coils for 12 to 52 metres or for complete coverage, 16/9 extra.

2 Stage PRESELECTOR

Radio Frequency Amplifier using "E" series valves. **£6.15s.** Continuous wave-range 7 to 550 metres. For use with any receiver and insures increased range, selectivity sensitivity and—for superheterodyne types—reduction to a minimum of second channel interference.

TERMS: 11/9 deposit and 12 monthly payments of 11/7.

CUT and POST

Please send me FREE TROPHY LISTS.

Name.....
Address.....

Wireless World
Pre-Set Quality Receiver
RECEIVER CHASSIS ready drilled with screens ... 39/6
AMPLIFIER CHASSIS ready drilled ... 27/6

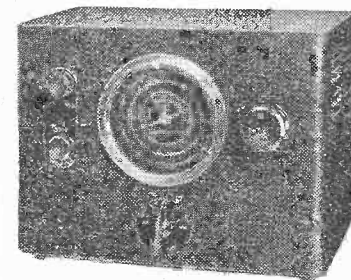

Two R.F. stages provide an exceptionally high gain, and in operation this Preselector is both positive and noise-free.

PETO SCOTT CO. Ltd. 77 (W.W.1), City Rd., London, E.C.1. Tel.: Oldiswell 9876
41 (W.W.1), High Holborn, W.C.1. Tel.: Holborn 3248

VISIT ONE OF OUR SHOWROOMS IF POSSIBLE

Go to your Dealer & ask for EDDYSTONE SHORT WAVE COMPONENTS



SEND FOR CATALOGUE

Condenser Cradle. Enables three microcondensers to be mounted as three gang condenser unit. Rotors and stators completely isolated. Brass division plates available for screening condenser units. No. 1114, 3/6. Metal screens, No. 1125, 8d. pair.

Neutralising Condenser No. 1088. For H.F. circuits using low-capacity triodes. Maximum voltage 2000 volts D.C. Capacity variation 1.8 mmfd. Frequentite pillar insulator mounting, insulated adjusting knob. 6/6

HIGH-VOLTAGE MICRO-DENSIFIER. Soldered brass vanes. Constantly maintained capacity; very low minimum 3 mmfd. DL9 Insulation. 1" spindle extended for ganging. Peak flashover voltage 3,500 volts. Easy co gang—capacity matched within 1 per cent. o. 1094, 3/9

Flexible Coupler. Free from backlash but very flexible. Banishes alignment troubles. DL-9 HF insulation. 1" spindles. No. 1009. 1/6

Slow Motion Driving Head. No. 1012. Very useful for Transceivers and Ultra Short Wave Receivers. With 9:1 reduction ratio; pointer moving through 180 degrees. 3/-

Air Dielectric Trimmer. DL-9 insulation 3 to 65 mmfd. For all pre-set and trimming purposes, particularly with IFT transformers. No. 978, 3/6

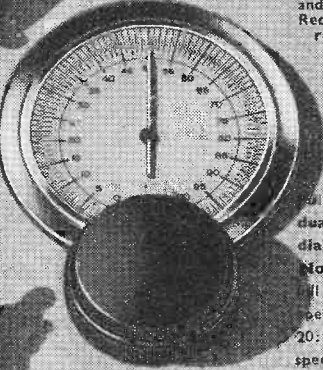

All vision dual speed dial. No. 1070. A all vision dual speed dial with 20:1 and 100:1 speeds. Well graduated scale, reading increasing as frequency increases. For 1" panel and 1/2" spindles. Ideal for H.F. tuning. 10/6

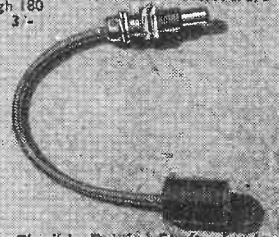

Flexible Driving Shaft. For front panel control of awkwardly placed components. Drives through 90 degrees perfectly. Cable length 31". No. 1096. 3/6

WRITE FOR CATALOGUE



EDDYSTONE SHORT WAVE RADIO COMPONENTS

MANUFACTURED BY STRATTON & CO. LTD., BROMSGROVE ST., BIRMINGHAM (LONDON SERVICE, 14 SOHO ST., W.1)

EDDYSTONE

LONDON SERVICE:

WEBB'S RADIO, 14, SOHO STREET, LONDON, W.1

COMPREHENSIVE RANGE OF COMPONENTS ALWAYS IN STOCK

THE ONE AERIAL FOR THE MODERN SET

PIX INVISIBLE AERIAL

STAND No. 64, OLYMPIA.

Pix, London, S.W.4.

Neat
Efficient
Blends with furnishings
Self-Adhesive

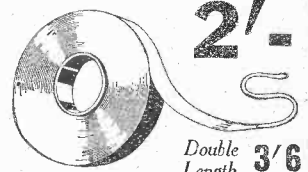

THE WIRELESS ENGINEER

MONTHLY 2s. 6d. NET
Subscription
32s. per annum, post free.

The Journal of Wireless Research and Progress

"THE WIRELESS ENGINEER" is published in the interests of professional wireless engineers, educational authorities, students, and all those who are intimately associated with wireless development.

A valuable and unique feature consists of a monthly summary, under the title of Abstracts and References, of all important articles appearing in technical wireless publications in all languages throughout the world.

LIFFE & SONS LTD., DORSET HOUSE, STAMFORD STREET LONDON, S.E.1.

Mention of "The Wireless World," when writing to advertisers, will ensure prompt attention.

NEWS OF THE WEEK

THE B.B.C. AT OLYMPIA

Exhibits of Technical Interest

MINIATURES of Broadcasting House and the Alexandra Palace tower are features of this year's Radiolympia, which Sir Stephen Tallents opened yesterday by television from Alexandra Palace.

The B.B.C., concentrating on technical exhibits, has aimed at demonstrating to visitors precisely how the "wheels go round." There is a recording van; complete with studio and apparatus, including four microphones with a fading and mixing unit.

The mobile film recording unit which is on exhibition consists of a motor car with a specially strengthened roof on which a camera with its tripod and operator may be carried. The camera is also adapted for sound.

The function of this unit is to make permanent records of outside events so that in addition to the actuality television transmission of these events they can be repeated in subsequent television programmes. Another important function of this unit is to provide actuality backgrounds for superimposition on ordinary studio programmes.

Transportable O.B. Apparatus

The aerial of the mobile television unit, with its portable mast 80ft. in height, the design of which is based on a lightened form of fire escape, will doubtless attract attention.

Although a specially balanced cable is sometimes available for television outside broadcasts, an additional length of ordinary Post Office telephone line has to be requisitioned to link up with the nearest point of the balanced cable. For this extension transportable repeater stations are necessary, and one of these is to be seen.

The recently introduced micro-wave transmitter, which is worn by the commentator on his back for sound O.B.s, is another interesting exhibit. When in use, the signals from this pack transmitter are picked up by the O.B. van at some point up to half a mile away.

Television Film Equipment

Another interesting exhibit is the apparatus for televising standard cinema films, such as news reels. The equipment, which is in duplicate to avoid breaks between reels, consists of an Emitron camera and a film projector which throws an image on to the mosaic of the Emitron. Unlike the standard projec-

tors previously used by the B.B.C. for film transmissions, the motion of the film is continuous. A system of mirrors tilts the projecting light in a beam which moves across the gate at the same speed as the film. Another and similar system of mirrors reflects the projected picture rays on to the Emitron screen.

An "optical fading" device comes into operation between frames. This produces a gradual decrease in the illumination of each frame as it leaves the film gate, and a simultaneous increase in the illumination of the new frame as it moves into the gate. It eliminates flicker and obviates the necessity of maintaining perfect synchronisation between the speed of the film frames and the television frame-scanning frequency.

Radiolympia Cinema

B.B.C. engineers have made recordings of reception of various

TECHNICAL CONVENTIONS

Details of Radiolympia Feature

HOUSEHOLD names among readers of *The Wireless World* are to be found in the list of those who will take part in the popular technical conventions, which are a feature of this year's radio show, which opened at Olympia at 11 a.m. yesterday (August 23rd).

Complete details of these conventions, which were not available for inclusion in our last week's issue, are given at the top of the next page. They are open to any visitor to Radiolympia and no special tickets are required.

Admission to the dealers' television convention, which is being held to-day (Thursday), is by special ticket, while admission to the two dealers' radio conventions will be by dealers' season ticket or a trade card. These will be held at 3.30 on August 30th and 31st and the subjects will be "Retail Sales Promotion" and "Wavelength Changes" respectively.

SHORT-WAVE INTER-FERENCE

Seeking Motorists' Co-operation

IN a letter to motorists, which was published in last week's issue of *The Autocar*, Mr. R. P. Browne, secretary of the Radio Manufacturers' Association, points out that the magnitude of the electrical disturbance radiated by the ignition systems of cars is dependent to a very large extent on the disposition of the various components. For example, a compact assembly with short HT leads and with the coil mounted on the engine block brings about a marked reduction in the disturbance level.

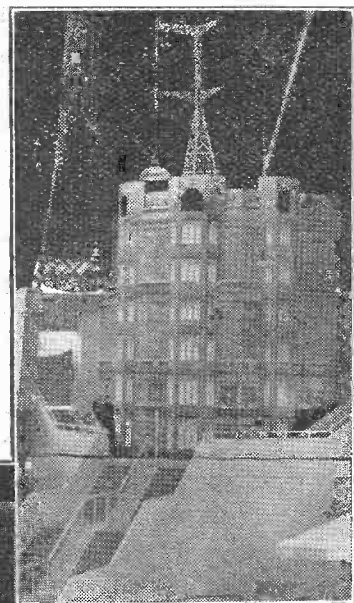

THE PREDOMINANT FEATURE of Radiolympia is a model of Broadcasting House, as will be seen from this photograph taken a few hours before the opening of the show. The Alexandra Palace tower in miniature is at the opposite end of the hall. The flat-roofed stands are built to a uniform design.

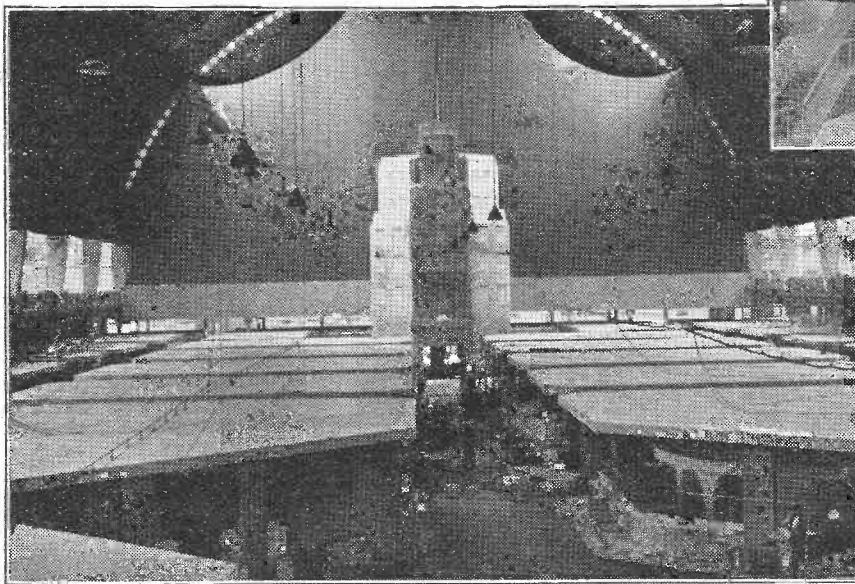

types of programme as reproduced on modern sets and sets that are not so modern. The two double-sided discs, which give a quarter of an hour's recording, are played over to each audience in the R.M.A. cinema, which has seating accommodation for over 500. They will be accompanied by a specially prepared Gaumont-British film.

Three or four documentary films, which show various makes of wireless receivers in the course of construction, are shown at intervals each day. The cost of admission to the cinema is threepence.

All the conventions will be held in a special room in the Empire Hall, which is reached from the Grand Hall Gallery. Each convention will last for about two hours.

Members of the R.M.A. Technical Advisory Committee will be present at each of the popular technical conventions.

It is hoped that readers of *The Wireless World* planning to visit Olympia will endeavour to do so on the day when their pet subject is being discussed and thereby take full advantage of the unique opportunity which the conventions afford.

In each of the thirty-two vehicles tested the electrical radiation is stated to have been materially reduced by this method.

While this simple reassembly produces considerable benefit to the owners of short-wave and ultra-short-wave radio receiving apparatus, motorists are asked in the letter to give consideration to any additional steps which will still further improve matters. "For example," says Mr. Browne, "the insertion of a suppressor resistance in the coil-to-distributor lead will, in a very large number of cases, remove

News of the Week—

ignition interference entirely, and yet the cost is only of the order of 1s. 6d."

The letter closes with the following appeal to motorists: "May we seek the public-spirited co-operation of motorists in the adoption of these suggestions? By so doing, they will add materially to the pleasure of radio set users, and incidentally extend the range and efficiency of those inter-communication systems now being employed by His Majesty's Forces for military and other purposes."

THE LISTENER AND HIS SET

M R. R. A. WATSON WATT'S broadcast talk on the ordinary listener and his set, given in the National programme last Thursday, was very interesting and must have been an eye-opener to many listeners on the inefficiency or the effects of the maladjustment of their sets. The recordings demonstrating the various points raised by Mr. Watson Watt were very convincing, especially those illustrating the prevalent fault among the uninitiated of mistuning.

It has been said that it is not the job of the B.B.C. to educate listeners to get the best from their receivers, but whether it is its job or not, an occasional broadcast such as Mr. Watson Watt's would do much to enlighten that hypothetical being, "the average listener," on the

FROM ALL**QUARTERS****Broadcasting in Yugoslavia**

THE Yugoslav Government issued a decree last week cancelling the concessions of the Belgrade and Zagreb broadcasting stations. It is stated that the reason for this move is that the company was not in a position to increase the power of these stations which is 20 kW and 0.7 kW respectively. Broadcasting is to be controlled by the State and it is proposed to erect nine stations. The stations replacing the above will have a power of 120 kW and 60 kW respectively.

New Relay Station

It is proposed to erect a low-powered station and a short-wave receiving centre near Khartoum (Anglo-Egyptian Sudan) for the main purpose of receiving and relaying the B.B.C. Empire Service.

Broadcasting Station for Bangalore

THE Government of Mysore State have decided to establish a broadcasting station in Bangalore. The plans and estimates of the proposed scheme, for which a sum of Rs.100,000 has been sanctioned for the current year, are being considered.

POPULAR TECHNICAL CONVENTIONS**To be held at Olympia**

August 28th: 3.30. "British Technical Progress and Some Comparisons with America." Chairman, Major L. H. Peter. Speakers, Mr. M. G. Scroggie, Mr. T. E. Goldup and Mr. G. Parr.

August 29th: 3.30. "Quality Reproduction and What it Means To-day." Chairman, Mr. Leslie McMichael. Speakers, Mr. P. G. A. H. Voigt, Mr. A. B. Calkin and Mr. G. A. V. Sowter.

August 30th: 6.0. "Short Waves." Chairman, Mr. E. M. Lee. Speakers, Dr. R. C. G. Williams and Mr. F. E. Henderson. Also on platform, Mr. N. R. Bligh, Mr. L. A. Moxon and Mr. R. A. Watson Watt.

August 31st: 6.0. "Television." Chairman, Mr. H. J. Barton-Chapple. Speakers, Mr. R. G. Clark, Mr. J. H. Owen Harries and Mr. T. C. Macnamara. Also on platform, Mr. J. L. Baird and Capt. S. R. Mullard.

shortcomings of obsolete receivers.

NORWEGIAN ANTI-INTERFERENCE CAMPAIGN

A DEPARTMENTAL committee appointed by the Norwegian Government to investigate the question of radio noise suppression has suggested the setting up of a public system under the auspices of the Post Office. The scheme provides for the country being divided into six districts under the supervision of regional noise-suppression inspectors. The cost of maintaining this service, which will be free to listeners except in cases where it is found that the fault is in the listener's apparatus, will be borne by the Post Office.

Radio-Nations

THE renouved offer for sale of the League of Nations station, Radio-Nations, at Prangins, is not strictly accurate. The position is that the ten years' agreement between the League and the Swiss Government is soon due to expire, and the matter is therefore to be discussed at the next meeting of the Assembly on September 11th. The station, which is used for disseminating League news on the short waves and for telegraphy on the long and short waves, is said to cost the League between £10,000 and £12,000 annually for maintenance.

N.B.C. Television

TELEVISION images from the National Broadcasting Company's station W2XBS in the Empire State Building are being picked up regularly by Mr. Dean R. Barker, who operates the amateur station W1JLY near West Falmouth, Mass., 185 miles from New York. This is a new long-distance reception record in America, where the previous record, established in June, stood at 130 miles.

New Bulgin Director

MR. H. T. STOTT, who has been chief technician of A. F. Bulgin and Company for the past eight years, has been elected to the Company's Board of Directors.

Authorised Aerials

REVISED rules pertaining to the installation and construction of aerials in Finland are being prepared by the Suomen Yleisradio in collaboration with the Electrical Inspectorate. New provisions lay down that aerials intended for use with mains-operated receivers shall only be installed by persons authorised by the local electricity companies.

Malayan Trade

IN a report on economic and commercial conditions in Malaya, recently issued by the Department of Overseas Trade, the total value (Straits dollars) of wireless receiving sets imported into Malaya in 1938 is given as \$405,000, as compared with \$482,000 in the previous year. Of this total \$152,000 worth came from the United Kingdom and \$127,000 from the U.S.A. The previous year's figures were: U.K. \$175,000, U.S.A. \$214,000.

Marconi Museum

THE villa in Pontecchio, near Bologna, Italy, where Marconi conducted his early experiments, is to be maintained as a museum. The villa has been given to the "Guglielmo Marconi Foundation," created by Signor Mussolini shortly after Marconi's death.

Scandinavian Licences

A RADIO density of just over 206 sets per 1,000 inhabitants has been reached in Sweden, where the total number of licences in force at the end of June was 1,301,656. The latest returns published by the Finnish broadcasting organisation show a total of 328,090 licences in force in Finland.

The Leipzig Autumn Fair

SOME 6,300 firms have announced their intention of exhibiting at the Leipzig Autumn Fair which is to be held from August 27th to 31st.

The "Q" Code

IN a notice to airmen, attention is drawn to the publication of a new amended impression of Air Publication 1529 ("The 'Q' Code and Other Abbreviations to be used in the Civil Aeronautical Radio Service"). Copies are obtainable, price 1s. net, or 1s. 2d. post free, from His Majesty's Stationery Office or through any bookseller.

Visitor from South Africa

PROFESSOR M. C. BOTHA, chairman of the South African Broadcasting Corporation, sailed for England on August 11th, and is due to arrive at Southampton in the *Stirling Castle* early tomorrow morning (August 25th). Although Professor Botha is not coming to this country on business, arrangements have been made to receive him at Broadcasting House and Alexandra Palace.

People's Set on H.P.

HUNGARY'S first People's Set, which is mains operated, has made its appearance. The cost, 48 pengös (approximately £2), which includes the licence fee, can be paid in twenty-four monthly instalments.

C.B.C. Chief Returns

MAJOR W. E. GLADSTONE-MURRAY, general manager of the Canadian Broadcasting Corporation, who has been on a month's visit to England with Mr. L. W. Brockington, K.C., chairman of the Corporation, made his return journey in the American flying boat *Dixie Clipper* on August 16th.

Chinese Radiophone Service

FOLLOWING the opening of the radio-telephone link between Chungking and Hong Kong on Tuesday of last week, it was announced that preparations are in hand for linking Chungking with Hanoi, Rangoon, Singapore, Manila and Bombay.

Berlin Television Curtailment

THE transformation of the Adolf Hitler Square in Berlin's West End into the circus that is to be known as Mussolini Place is the reason for the sudden decision of the German broadcasting authorities to curtail the television transmissions which, since August 7th, had been radiated from 5 until 10 p.m. The city officials refused to stop the two rams working immediately in front of the television studios, which are on the ground floor, except between the hours of 8 and 11.

B.E.R.U. Contest

TO South Africa goes the honour of first place in the annual transmitting contest staged by the British Empire Radio Union. Mr. R. G. Henwick, ZS2AL of Port Elizabeth, was first in the senior section for high-power stations. In the junior section, in which inputs must not exceed 25 watts, Mr. J. M. Drudge Coates, VU2FO, obtained first place for India.

Mr. B. Walton O'Donnell

IT is with regret that we record the death in Belfast last Sunday of Mr. B. Walton O'Donnell at the age of 52, after a brief illness. When in 1937 he relinquished the post of conductor of the B.B.C. Military Band, which he created, to become B.B.C. Northern Ireland music director, he was succeeded by one of his two bandmaster brothers, Major Percy O'Donnell.

Simplifying Television Controls

DOES THE "CONTRAST" KNOB ALWAYS DO WHAT IT SAYS ?

A RATHER interesting little repetition of history is going on just now. The old controversy about how many knobs a receiver should have and where they should be put is being gone into all over again for television. Some vision receivers have—or, perhaps, I should say *had*—quite an impressive array of controls on the front panel, but it is common now for the number to be as few as two—less than in even simple types of sound receiver. One is Sound Volume, combined with the on-off switch. The other is generally Contrast, but in at least one of the new models it is Brightness.

And that is where history repeats itself in detail. Were you (or, perhaps, are you?) a pre-superhet age listener? The very old sets—1926 and thereabouts—had a Reaction control and no Volume control. There was never any surplus volume to be controlled in those days. The modern straight sets usually have Volume control but no Reaction. During most of the intervening years they had both. That was the time, before superhets became general, when the growth in the number of stations made selectivity the most pressing need. The results depended less on the set itself than on who was handling it. The radio-minded person, who was able to grasp the principle of complementary adjustment of Reaction and Volume controls, could quite easily separate stations which to the ordinary public were hopelessly mixed. It is a very simple process really, but have you ever tried to explain it in writing? Even when given a course of personal tuition

By

"CATHODE-RAY"

Most television receivers have a number of subsidiary controls which do not appear on the panel. In *The Wireless World* Magnetic Television Receiver there are four of these and as they require only occasional adjustment they are set back from the front. The two panel controls—Brightness and Contrast—are connected to the chassis by flexible leads and do not appear in this photograph.

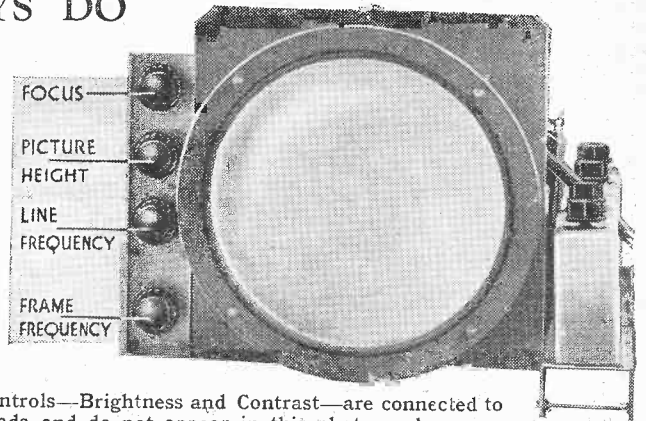

the vast majority of people seem incapable of grasping the idea that the Volume control makes *everything* louder, but the Reaction control only the station to which the set is tuned; therefore, by increasing Reaction and reducing Volume, the volume of the wanted station can be kept constant and that of interfering stations reduced.

Brightness or Contrast?

Of course, the customer is right: "Reaction" means nothing sensible, and if it is really for controlling selectivity why does it alter volume? Some schemes were worked out for coupling up a volume control to the Reaction knob so that it could be truly labelled "Selectivity," but it was very difficult, because the effect of reaction is critical near the oscillation point, and that point shifts according to the setting of the tuning control. Before the slide-rule kings got the better of this problem the superhet swept the market and saved them the trouble.

And now the same sort of thing has re-

appeared with television. In general, the set is far easier to work than the ordinary broadcast receiver. If it is worth its salt at all, the Line Hold, Frame Hold, Tuning and Focus controls should rarely need readjustment in order to get reasonably good results. The really essential thing is to turn it on (and, in due course, off), adjusting the sound volume with the same knob to suit requirements. Anybody can do that. And if they are easily pleased, that is usually all they need do. But at times the picture is obviously too light and at other times too dark. If one is a little more critical, the contrast occasionally needs adjustment to make the best of the transmission.

That is just where the trouble begins. The laymen (usually women) of the family who want to get past the on-volume-off stage look around and find a knob marked "Contrast." Beside it, or round the side or back, or under a flap, they see another marked "Brightness." Gingerly they give each in turn a slight twist. Each apparently has the same effect, of making the picture lighter or darker. Then why

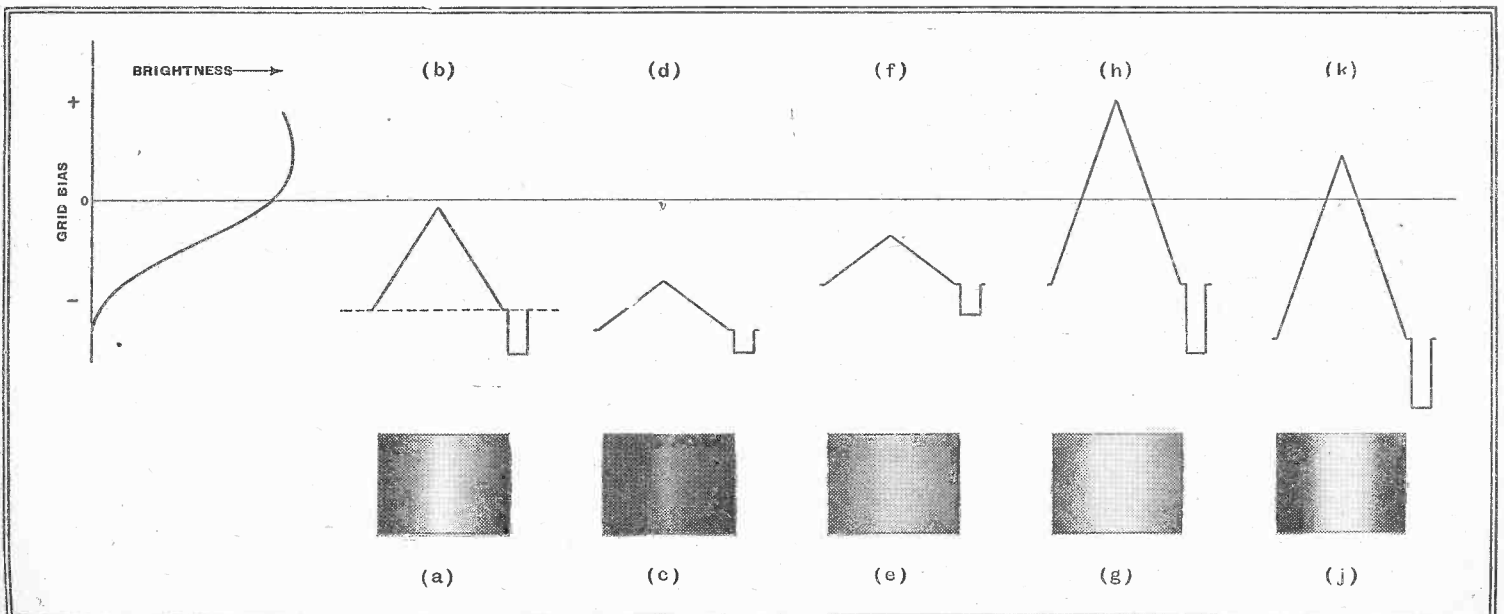

Illustrating the effect of operating the Brightness and Contrast controls of a television receiver.

Simplifying Television Controls—

have two? What is the difference? Perhaps you come in and find the picture hopelessly flat, or, more likely, contrasty. You may make sarcastic remarks about it, but can you explain how to put it right? If Contrast is adjusted the picture goes either too light or too dark before any useful result is gained. Oh yes, you say, and taking a knob in each hand you turn them in opposite directions, keeping the brightness constant and correcting the wrong contrast. Very cleverly done, but you will be cleverer still if you can teach the family this trick, especially if (as sometimes happens) turning the Contrast knob up beyond a certain point *reduces* the contrast again, due to overloading.

The point is, the family ought not to have to be taught this. Contrast and Brightness should mean what they say. Of course, we who know what is behind the screens realise that the Contrast knob varies the strength of the vision signal, while Brightness controls the grid bias of the vision tube. Suppose, for the sake of demonstrating the point, that Alexandra Palace is transmitting a pattern consisting of blackness at the right- and left-hand edges, shading gradually into whiteness down the middle, as at (a) in the diagram. Then each line transmitted is of the form shown at (b). The part above the dotted line is the vision signal proper, rising from black to white and back to black again; the part below, the "blacker than black," is the synchronising signal. This is applied to the grid of the cathode-ray tube, controlling the brightness of the screen somewhat, as shown by the characteristic curve at the extreme left of the diagram. Normally, the grid bias (Brightness knob) is adjusted so that the synchronising part of the signal is enough to bring the grid voltage just short of the point at which light begins to appear on the screen, making the start and finish of each line give "black"; and the amplification (Contrast knob) so that the peak of each line gives enough brightness for a clear white. The intervening shades are then faithfully depicted.

Correlated Adjustments

Now suppose that a less contrasty picture is desired. Naturally, the knob marked Contrast is turned back a bit. The effect is to make the whole signal shrink, as shown at (d). (Incidentally, owing to the synchronising pulse being weakened, the line and frame hold controls may have to be more carefully adjusted.) Here half the vision signal is in the "blacker than black" region, and even the peak corresponds to a very dim screen (c). Therefore, the result is that the general brightness of any picture is so much reduced that it is difficult to tell what has happened to the contrast. However, by moving *Brightness* in the increasing direction (f), the desired reduction in contrast (e) is obtained at the original average brightness.

If instead of turning Contrast back we had turned it forward, increasing the amplitude of signal (h), the blacks would

have been lost; but as the whites were already as much as the tube would give, the area of white would be increased, and there might even be a certain amount of reversal of image at the extreme peaks (g). Turning back Brightness to regain the original average (k), all the darker shades are completely black, and all the lighter tones are completely white, giving an excessively contrasty picture (j), usually described as soot and whitewash.

Compensated Contrast Control

For *small* adjustments of brightness, such as may be helpful during the course of a programme, it doesn't matter very much whether Brightness or Contrast is used. As the signal strength is more liable than the grid bias to be affected by various influences, Contrast has, perhaps, the better claim of the two to the honour of a place on the front panel. In other words, Contrast is used for adjusting brightness. If, however, a definite change of contrast is desired to suit the personal taste of the viewer, it is necessary accord-

ing to present arrangements to bring Brightness into action, juggling with both controls.

The obvious thing seems to be to compensate the Contrast control for brightness. This could be done by coupling a subsidiary bias-control potentiometer to the Contrast spindle, arranged to reduce bias when the amplification is reduced, and vice versa. Of course, it isn't so simple as it may sound; the "laws" of the two would probably have to be balanced rather cunningly; and one would expect the balance to be upset by various circumstances. However, it could hardly be more difficult than superhet tracking, which seems to have been managed pretty well all these years. And, even if the compensation was not perfect, it would still be much better than nothing. The change of contrast could, no doubt, be observed well enough to judge the right setting for the knob of that name, after which a touch one way or the other of Brightness might be needed to get the best result. Things would mean what they say, which is a great help in this life.

Random Radiations

By "DIALLIST"

Radiolympists All

THIS is written almost on the eve of the opening of Radiolympia, which will be in full swing by the time that it appears in print. I hope that will be very full swing, for there's plenty to attract everyone from pieman, to π -man, from sign-writer to sine-writer, from log-merchant to "log"-merchant, from average-duffer to average-adjuster, from junior wrangler to senior wrangler. High-brows, middle-brows, low-brows and no-brows will all find something to their respective tastes. Whether your main interest lies in beauty queens or loud speakers of the inanimate kind, the exhibition authorities are providing for you. You can feast your eyes at the stands of the lions of the wireless industry or your lips at those of the Lyons of the catering world. Be your present set AC or DC, AD or BC, experts will demonstrate why it should be consigned to the dust-bin and replaced by a new model. To whatever category of visitor you may belong your quest will doubtless be to discover the best receiver in the show. Here I can give you an infallible tip that saves an infinity of time and trouble. Go to the first stand you come to on which sets are displayed and ask the man in charge; he will tell you without an instant's hesitation.

■ ■ ■

For the Corner

YEARS ago I flung out the suggestion that wireless sets in triangular cabinets would sell like the hottest of cakes. I wasn't then, nor am I now, thinking of cabinets with a three-cornered elevation; it's the plan, the horizontal cross-section, three-sided instead of four, that I was and still am after. For why? Because the modern labour-saving home, whether house or flat, is apt to be on the small side and

I'm sure that the receiver which would stand in a corner (or even be fixed to the walls there) would be immensely popular with the modern housewife and her worse half. I know that there are difficulties about chassis and layout; but it can be done, because I know home constructors who've done it. There is another advantage, too, about this shape, besides the space that it saves: the walls act as most admirable "baffle extensions," enabling the loud speaker to fill the room with sound in the most natural way. With the corner set you don't get that rather unpleasant impression that the sound is focused on to your ear from one point. Won't some enterprising set manufacturer take a chance with the triangular cabinet? I don't think he'd regret it.

■ ■ ■

The Great Dial Question

FEW radio matters have caused such a stir this year as the great question of the station named tuning dials. After a vast amount of cerebration and argument it has at length been decided that all those you behold at Olympia shall bear stations arranged in the pre-Montreux order. Receivers sold between now and the end of the year can have up-to-date dials fitted when the time comes at a small fixed charge; those on the market after the beginning of next January will have the new dials. If your set, though not new, isn't more than two years old, you may be able to get a "Montreux" dial, though it will cost rather more than one for a new model. So that's that. It seems a sensible solution; there'll be grumbles, no doubt—but they would have arisen whatever had been done. I don't think I shall be in too much of a hurry to change the dial of my "broadcast"

receiver when the time comes; its not unlikely that certain wavelength exchanges will have to be made when the plan ceases to be merely a paper one, and is put into actual practice.

Metres Per Kilowatt ?

"THESE broadcasts," says my morning paper, "are being made on a very powerful wavelength." It omits to explain how a wavelength is made powerful. I imagine that it is done by means of the familiar current of a million volts. By passing this into the aerial an electrical pressure of many thousand amperes is, of course, readily obtained. The wavelength then becomes sufficiently powerful to travel round the earth in less than a single minute. And if all the waves generated during one programme could be placed end to end they would stretch to goodness knows where and probably back again as well.

Changed Call Signs

IT'S rather unkind in one way of the Federal Communications Commission to start altering the call signs of the U.S.A. short-wave stations that have become so familiar after years of use. I suppose really that we'll soon get used to thinking of the ex-W8XK as WPIT and the former W1XK as WBOS, and so on; but I'm sure I'll find myself saying and writing W2XAD and W2XAF instead of WGEA and WGEO respectively. The other changes that I know of so far are W6BE into KGEI and W3XAU into WCAI; but these aren't by any means all: there are plenty more to come. The reason for the changes is that the F.C.C. considers that the time has now come for the leading short-wave stations of the U.S.A. to be officially recognised as permanent and "professional" concerns.

Call-sign Humour

Some of the call signs in different countries are very happily chosen or allotted. The classic example is, of course, the old Eiffel Tower, whose FL is pronounced exactly like Eiffel in French. But America has some that are quite as good. There's WACO, for instance, of Waco, Texas. And what about KUMA, of Yuma, Arizona, or WATR, of Waterbury, Conn., or WORC., of Worcester, Mass., or WNOX, of Knoxville, Tenn.? Some other U.S.A. call signs indicate the state, not the town: WISC, Milwaukee, Wis.; WPEN, Philadelphia, Pa.; WIND, Gary, Ind.; WMAS, Springfield, Mass.; and so on. Others, again, were, I suspect, chosen because they looked and sounded striking—WHAM, KNOW, KICK, WORK, WINS, WAVE, KID and WOW seem to fall into this category. One imagines that KROC, WEED and WREC had to be accepted willy-nilly! Russia has or had the very aptly named RUS and RED, and Tokio's JOAK looks just the station to tune in for light entertainment. PRAY (Brazil) sounds serious.

No Longer "Amateur"

There are several curiosities in the history of the call signs of both medium-wave and short-wave broadcasting stations. The first U.S.A. short-wave broadcasts were made, unless my memory is at fault, by a relay of KDKA at Pittsburg, working on a wavelength of about 65 metres. This pioneer short-wave station had no call sign of its own, announcing itself by the parent sta-

tion's letters. Next came a period in which short-wave transmitters in the U.S.A. relaying broadcast transmissions were assigned special call signs consisting entirely of letters and with no numbers in them. The next step was to treat short-wave broadcasting stations as if they belonged to the amateur class by giving them call signs which included the distinguishing numbers of the regions into which the F.C.C. had divided the country. The change that has just been made recognises the short-wave stations as regular professional transmitters by allotting them four-letter "W" or "K" call signs. In this country the B.B.C.'s original medium-wave stations had amateur call signs such as 2LO, 2BD, 6BM, and so on—the "Gs" weren't added to British amateur call signs till later. The Empire short-wave services, however, started their careers as fully fledged professional stations with three-letter "GS" call signs.

Television Programmes

Sound 41.5 Mc/s Vision 45 Mc/s
Each weekday morning during the period of Radiolympia in place of the usual demonstration film from 11 to 12 will be seen the feature "Come and be Televised" in which Jasmine Bligh and Elizabeth Cowell will interview members of the public at Olympia. The National or Regional programme will be relayed on 41.5 Mc/s from approximately 7.45 to 9 p.m. daily.

THURSDAY, AUGUST 24th.
3, 259th edition of Picture Page.* 3.30, Cabaret with Jean Colin and Cyril Fletcher. 4-4.30, The Zoo. A visit with F. H. Grisewood to the Regent's Park Zoo.

9, Alfredo and his Gypsy Orchestra. 9.30, Gaumont-British News. 9.40, Interest Film. 9.50-10.20, "Johnson was no Gentleman," a comedy by H. F. Rubinstein. Cast includes Robert Atkins and Joyce Redman.

FRIDAY, AUGUST 25th.
3, Kuda Bux, the man with the X-ray eyes. 3.10, Cartoon Film. 3.25, "A Bedfast Prophet," a comedy adapted for television, from "A Rogue in Bed," by Ronald Elwy

Mitchell. 4-4.30, The Zoo. O.B. from Regent's Park.

9, "The Kentucky Minstrels," presented by Harry S. Pepper.* 9.30, Albert Sandler, violin. 9.40, British Movietonews. 9.50-10.20, "Ending It," by Val Gielgud.

SATURDAY, AUGUST 26th.
3, 260th edition of Picture Page.* 3.30, Catch-as-Catch-can Wrestling. 3.45, Cartoon Film. 3.50, Leonard Henry. 4-4.30, The Zoo. O.B. from Regent's Park.

9.5, Cabaret, with Jean Colin and Edward Cooper. 9.35, Gaumont-British News. 9.45, Interest Film. 10.5-10.35, "The Coffin," a comedy by John Taylor.

SUNDAY, AUGUST 27th.
9.5-10.20, "A Cup of Happiness," a comedy by Eden Philpotts. Cast includes Leon M. Lion, Amy Veness and Roger Livesey.

MONDAY, AUGUST 28th.
3, Troise and his Mandoliers.* 3.30, C. H. Middleton.* 4-4.30, The Zoo. O.B. from Regent's Park.

9.5, "Bits and Pieces," light entertainment with Jackie Billings, Diana Chase and Bobbie Kimber. 9.35, Cartoon Film. 9.40, "Up from the Country." How electricity came to an Essex village. 10.10, Film, "Fingers and Thumbs." 10.25-10.40, "Coffee Stall," light entertainment devised by S. E. Reynolds.

TUESDAY, AUGUST 29th.
3, "The Ringer," by Edgar Wallace. Cast includes Henry Oscar and Judy Kelly. 4.30-5, The Zoo. O.B. from Regent's Park.

9, "The Kentucky Minstrels"* (as on Friday at 9 p.m.). 9.30, Tom Webster draws some sporting cartoons. 9.40, Derek Oldham in songs. 9.50, British Movietonews. 10-10.20, Intimate Cabaret with Oliver Wakefield and Irene Prador.

WEDNESDAY, AUGUST 30th.
3, Eve Lister in songs with Evel Burns at the piano. 3.10, British Movietonews. 3.20, "The Coffin" (as on Saturday at 10.5 p.m.). 3.50, Variety with Bebe Daniels and Ben Lyon. 4-4.30, The Zoo. O.B. from Regent's Park.

9, Gillie Potter. 9.10, Eric Wild and his Band. An Irving Berlin programme. 9.35, Gaumont-British News. 9.45, Night shots from the Zoo. O.B. from Regent's Park. 10-10.25, "The Happy Hangman," a grotesque.

* O.B.s from Radiolympia.

GERMAN PROJECTION RECEIVER

In producing the projection television receiver for home use shown in the photograph, the German Fernseh Company has used a small projection cathode-ray tube. The diminutive size of the tube can be gauged from the lower illus-

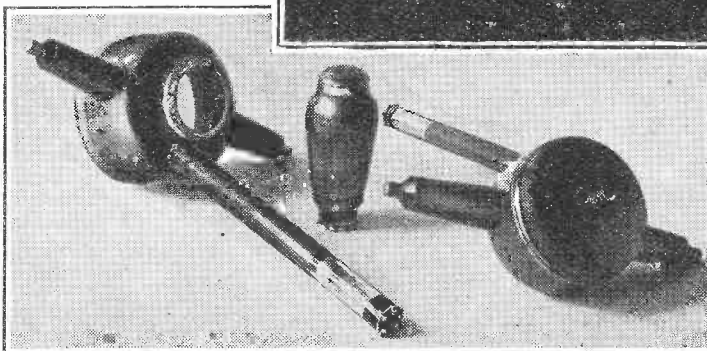
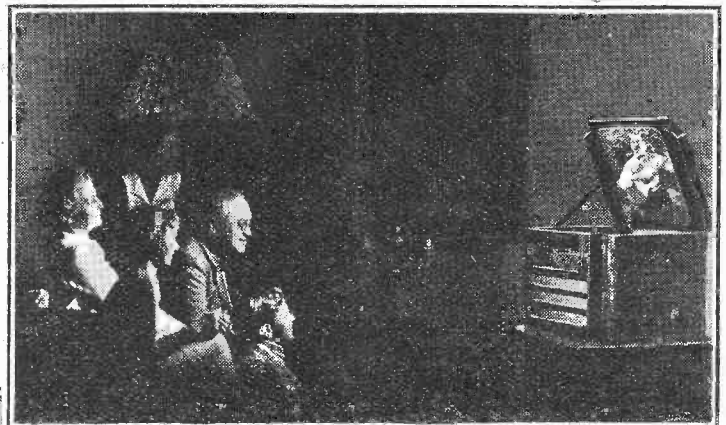

tration, where two of them are shown with an ordinary receiving valve. The receiver gives a picture 42 x 50 cm, which is viewed with the aid of a mirror. It is not yet available to the public; it has been decreed in Germany that only one standardised receiver is to be put into production.

Exhibitors at Olympia

ALPHABETICAL LIST WITH STAND NUMBERS AND REFERENCES TO THE
PLAN ON THE OPPOSITE PAGE

Name	Stand	Reference	Name	Stand	Reference
Aerialite, Ltd.	60	B 4	G.P.O.	80	C 6
Castle Works, Stalybridge, Cheshire.			Garrard Eng. & Mfg. Co., Ltd.	56	B 5
Antiference, Ltd.	10	A 3	Newcastle Street, Swindon, Wilts.		
176, Wardour Street, W.1.			General Electric Co., Ltd.	35	A 4
Armstrong Mfg. Co.	69	B 4	Magnet House, Kingsway, W.C.2.		
Walters Road, Nag's Head, Holloway, N.7.			Goodmans Industries, Ltd.	19	A 4
B.B.C.	76, 78, 79 & 96	C 5, C 6,	Lancelot Road, Wembley, Middlesex.		
		A 2	Gramophone Co., Ltd.	46 & 53	B 4
		A 6	108, Clerkenwell Road, E.C.		
Balcombe, A. J., Ltd.	37	A 6	Heyberd, F. C., & Co.	57	B 6
52, Tabernacle Street, E.C.			10, Finsbury Street, E.C.2.		
Baird Television, Ltd.	27	A 5	Hobday Bros., Ltd.	T. 6	B 2
Crystal Palace, Anerley Hill, S.E.19.			21, Great Eastern Street, E.C.		
Belling & Lee, Ltd.	3 & 26	A 6	Holsun Batteries, Ltd.	40	B 6
Cambridge Arterial Road, Enfield, Middlesex.			Neville House, Page Street, S.W.1.		
British Insulated Cables, Ltd.	20	A 4	Imhof, Alfred, Ltd.	70	B 4
Prescot, Lancashire.			112, New Oxford Street, W.C.1.		
British Pix Co., Ltd.	64	B 2	Invicta Radio, Ltd.	16	A 3
Pix Works, Lillieshall Road, S.W.4.			St. Andrews Road, Cambridge.		
British McMurdo Silver Co., Ltd.	107	B 1	Lawley Electrical Storage Company	83	C 5
17, Hertford Street, Park Lane, W.1.			27, Newton Street, High Holborn, W.C.2.		
British Railways, Ltd.	4	A 6	Lugton & Co., Ltd.	T. 9	A 2
Euston House, Eversholt Street, N.W.1.			203, Old Street, E.C.1.		
British Rola, Ltd.	24	A 5	McMichael Radio, Ltd.	38	B 6
Minerva Road, Park Royal, N.W.10.			Wexham Road, Slough, Bucks.		
British "Wireless for the Blind" Fund	58	B 6	Masteradio, Ltd.	97	A 2
226, Great Portland Street, W.1.			Mewton Street, High Holborn, W.C.2.		
Brown Bros., Ltd.	T. 8	B 2	Marconi-Ekco Instruments, Ltd.	109	B 1
Great Eastern Street, E.C.2.			Electra House, Victoria Embankment, W.C.2.		
Bulgin, A. F., & Co., Ltd.	62	B 4	Marconiphone Co., Ltd.	36	A 5
Abbey Road, Barking, Essex.			210, Tottenham Court Road, W.1.		
Burndept, Ltd.	54	B 4	Mercantile Credit Co., Ltd.	67	B 2
Light Gun Factory, Erith, Kent.			39-45, Finsbury Square, E.C.2.		
Bush Radio, Ltd.	34	A 4	Mullard Wireless Service Co., Ltd.	55	B 5
Power Road, Chiswick, W.4			Century House, Shaftesbury Avenue, W.C.		
Carr Fastener Co., Ltd.	66	B 3	Murphy Radio, Ltd.	33	A 3
Nottingham Road, Stapleford, Notts.			Broadwater Road, Welwyn Garden City, Herts.		
Celestion, Ltd.	25	A 5	New Era Publishing Co., Ltd.	5	A 6
London Road, Kingston-on-Thames.			12, Newton Street, W.C.2.		
Chloride Electrical Storage Co., Ltd.	2	A 6	New London Electron Works, Ltd.	59	B 5
231, Shaftesbury Avenue, W.C.2.			East Ham, E.6.		
Cole, E. K., Ltd.	47	B 3	Newnes, George, Ltd.	9	A 4
Ekco Works, Southend-on-Sea, Essex.			Tower House, Southampton Street, W.C.		
Cosmocord, Ltd.	72	B 5	Odhams Press, Ltd.	T. 1	A 2
Cambridge Arterial Road, Enfield, Middlesex.			93, Long Acre, W.C.2.		
Cossor, A. C., Ltd.	48	B 3	Philco Radio & Television Corporation of		
Cossor House, Highbury Grove, N.5.			Great Britain, Ltd.	31	A 2
Decca Radio & Television, Ltd.	44	B 5	Perivale, Greenford, Middlesex.		
1-3, Brixton Road, S.W.9.			Pilot Radio, Ltd.	42	B 5
Department of Overseas Trade	74	B 5	31-33, Park Royal Road, N.W.10.		
35, Old Queen Street, S.W.1.			Philips Lamps, Ltd.	45	B 4
Dew, A. J., & Co., Ltd.	T. 10	A 2	Century House, Shaftesbury Avenue, W.C.		
33, Rathbone Place, W.1.			Plessey Co., Ltd.	68	B 3
Dubilier Condenser Co. (1925), Ltd.	28	A 5	Vicarage Lane, Ilford, Essex.		
Ducon Works, Victoria Road, N. Acton, W.3.			Pye, Ltd.	32	A 3
Dynatron Radio, Ltd.	T & 39	A 6, B 6	Radio Works, Cambridge.		
Perfecta Works, Ray Lea Road, Maidenhead.			Radio Gramophone Development Co., Ltd.	29	A 4
Eastick, J. J., & Sons	T. 7	B 2	Globe Works, Newtown Row, Birmingham.		
118, Bunhill Row, E.C.			Reproducers & Amplifiers, Ltd.	111	B 1
Eavestaff, W. G., & Sons, Ltd.	73	B 5	Frederick Street, Wolverhampton.		
Autoplayer Factory, Ashfield Road, N.4.			Rose, Norman (Electrical), Ltd.	12	A 3
Econasign Co., Ltd.	14	A 2	43, Lamb's Conduit Street, W.C.1.		
92, Victoria Street, S.W.1.			Rothermel, R. A., Ltd.	71	B 4
Edison Swan Electric Co., Ltd.	23	A 5	Rothermel House, Canterbury Road, N.W.6.		
155, Charing Cross Road, W.C.2.			Royal Air Force	50	B 2
Elf, Gordon, Ltd.	21	A 4	Scophony, Ltd.	49	B 2
55, Rathbone Place, W.1.			Thornwood Lodge, Campden Hill, N.W.8.		
E.M.I. Service, Ltd.	100	A 1	Scott Insulated Wire Co., Ltd.	103	A 1
Sheraton Works, Hayes, Middlesex.			Queensland Works, Westmoreland Road, N.W.9.		
Erie Resistor, Ltd.	13	A 2			
Carlisle Road, The Hyde, N.W.9.					
Ferguson Radio Corporation, Ltd.	17	A 3			
105-109, Judd Street, W.C.1.					
Ferranti, Ltd.	41	B 6			
Radio Works, Moston, Manchester, 10.					

Name	Stand	Reference	Name	Stand	Reference
Selecta, Ltd. 81, Southwark Street, S.E.1.	T. 2	A 2	Ultra Electric, Ltd. Western Avenue, Acton, W.3.	43	B 5
Selmer, Henri, & Co., Ltd. 114, Charing Cross Road, W.C.2.	99	A 2	Vacuum Science Products, Ltd. 166, Weir Road, Balham, S.W.12.	18	A 4
Servisol, Ltd. 74, Renshaw Street, Liverpool.	11	A 3	Varley Cambridge Row, Burrage Road, S.E.18.	108	B 1
Siemens Electric Lamps & Supplies, Ltd. 39, Upper Thames Street, E.C.4.	52	B 3	Vidor, Ltd. West Street, Erith, Kent.	51	B 3
Steatite & Porcelain Products, Ltd. Stourport-on-Severn, Worcestershire.	61	B 4	War Office	77	C 6
Sterling Batteries, Ltd. Sterling Works, Dagenham, Essex.	65	B 2	Waverley Book Co., Ltd. 96, Farringdon Street, E.C.4.	8	A 4
Taylor Electrical Instruments, Ltd. 45, Fouberts Place, Regent Street, W.1.	101	A 1	Westinghouse Brake & Signal Co., Ltd. 82, York Way, Kings Cross, N.1.	30	A 4
Telegraph Condenser Co., Ltd. Wales Farm Road, Acton, W.3.	63	B 3	Wingrove & Rogers, Ltd. Mill Lane, Old Swan, Liverpool.	110	B 1
Telegraph Construction & Maintenance Co., Ltd. 22, Old Broad Street, E.C.2.	22	A 5	The Wireless Engineer Dorset House, Stamford Street, S.E.1.	6	A 5
Thompson Diamond & Butcher, Ltd. 34, Farringdon Road, E.C.	T. 3	B 2	Wireless Retailers Association, The 10, Ashley Place, S.W.1.	58A	B 6
Trader Publishing Co., Ltd. Dorset House, Stamford Street, S.E.1.	7	A 5	The Wireless World Dorset House, Stamford Street, S.E.1.	6	A 5
			Wright & Weaire, Ltd. 740, High Road, Tottenham, N.17.	102	A 1

Guide to the Stands

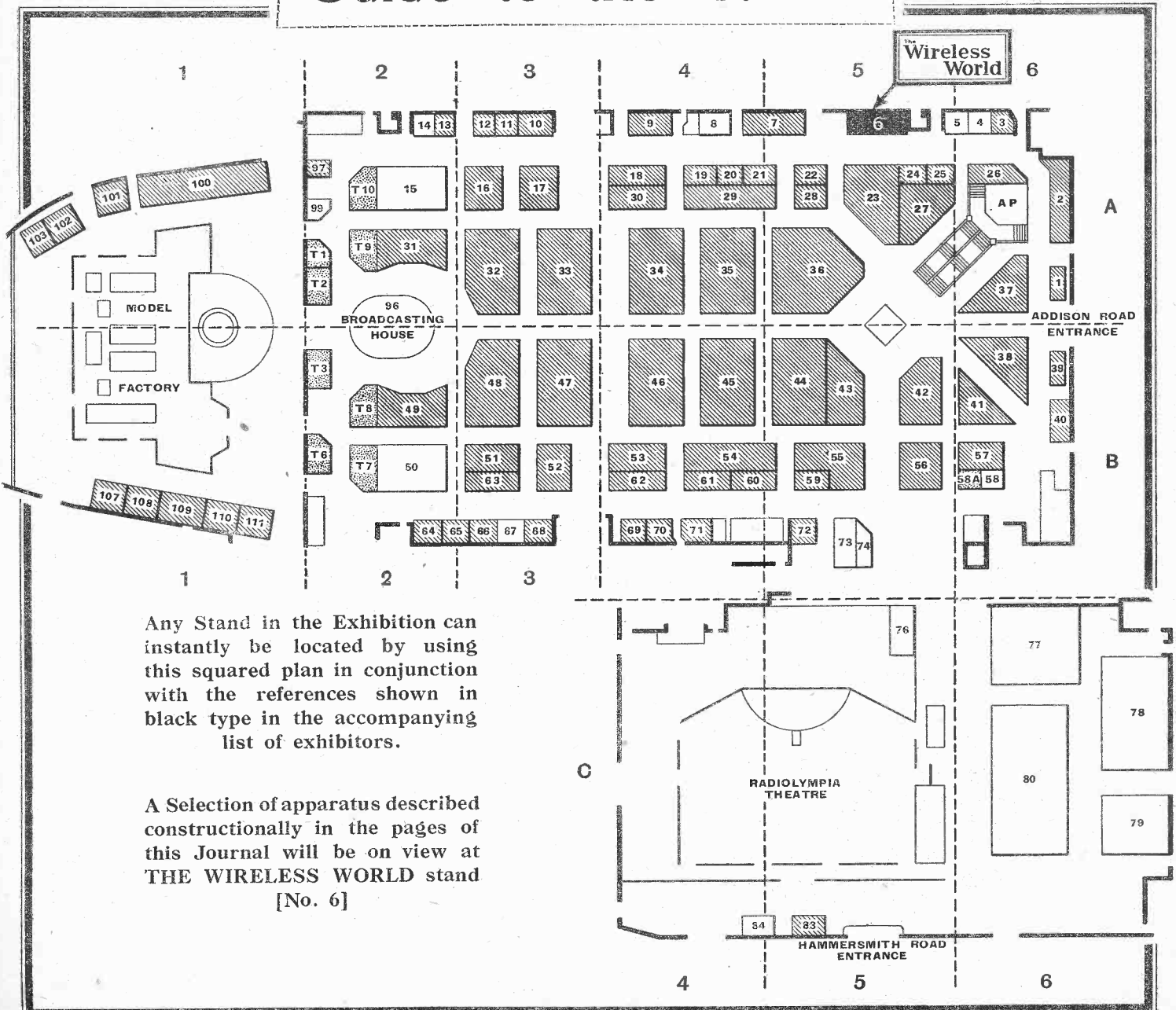

Any Stand in the Exhibition can instantly be located by using this squared plan in conjunction with the references shown in black type in the accompanying list of exhibitors.

A Selection of apparatus described constructionally in the pages of this Journal will be on view at THE WIRELESS WORLD stand [No. 6]

Exhibitors' offices, "Television Avenue," and the entrances to the Conference Hall and the B.B.C. Cinema are in the gallery above the Grand Hall.

UNBIASED

By

FREE GRID

A Technical Triumph

ALTHOUGH the radio show has been open for a complete day, I must confess that, contrary to my usual custom, I have seen very little of it indeed so far, and must defer giving you my impressions until next week when I trust I shall have had the opportunity of giving the show that thorough examination which a cursory look round seems to indicate that it deserves.

I am actually writing these few notes in one of the many bars at Olympia with several important wireless manufacturers on either side eagerly anxious to get a word in edgeways with me. It is in fact this very circumstance which is the explanation of my having seen very little of the show so far. I do not mean to indicate, of course, that I have spent the greater part of the day in the bar with wireless manufacturers; I have more important matters to attend to even if they have not. My meaning is that this meeting of manufacturers in the bar, and their evident anxiety to see that my glass does not remain empty, is the natural and logical outcome of my day's doings.

A Crying Need

The plain and simple reason why I have seen very little of Radiolympia so far is that I have spent practically the whole day among the nursemaids in the neighbouring Kensington Gardens which, for the benefit of non-Londoners, I may mention is nowadays the sacred preserve of these useful members of the community, and, moreover, a place where any man who is not either a policeman or a guardsman, has about as much chance of feeling welcome as a Thames bargee has at the R.Y.S. headquarters at Cowes. It was, in fact, only by representing myself to be a member of the Force enjoying a few days' holiday that I was able to break down the cold reserve of hauteur which the nursemaids reserve for outsiders.

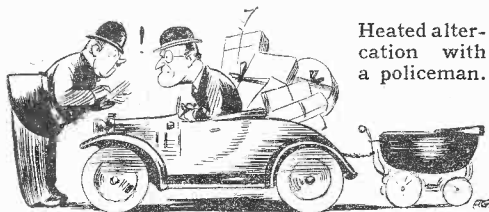

Heated altercation with a policeman.

I may mention that I have been frequenting these gardens until late at night for some weeks past, but in order to avoid any misunderstanding, I had better say at once that my visits have been made solely for technical reasons, although it was actually my humanitarian feelings, and not technical considerations, that initiated the present idea which sees its climax in the crowd of manufacturers surrounding me, all vying with each other for my favours.

The idea was born one lovely afternoon in June when I had gone into the Gardens to meditate upon the Albert Memorial and upon what manner of men it must have been who conceived its design. Meditation is always a reposeful pastime, and as I have always believed in the old adage that what is worth doing at all is worth doing well, I thoroughly let myself go with the result that I favourably attracted the attention of a nursemaid on the same seat who, from my evident familiarity with the aforementioned reposeful meditation, must have mistaken me for an expoliceman. At any rate, whatever be the explanation, she was soon pouring her woes into my ear with full and complete details of the hardness of her life and of the lives of all those of her ilk.

I was turning over in my mind what she had told me with a view to finding a remedy, when suddenly an idea occurred to me, and without, I fear, so much as a word of farewell, I left my companion in the lurch and hurried along to a well-known emporium where I purchased a modern baby carriage. As I was in a great hurry, and already had my car cluttered up with some of Mrs. Free Grid's shopping, I was compelled to tow the pram behind, this leading to a somewhat heated altercation with a policeman.

However, I got home eventually, and speedily set to work, toiling until far into the night, with the result that the following afternoon I was able to sally forth and seek my fair companion again. Owing to my somewhat abrupt manner of leaving her on the previous day she was rather loath to enter into conversation with me, but feminine curiosity as to my reason for pushing an empty pram eventually overcame her ill-humour. I had some little difficulty, however, in inducing her to transfer her small charge to my empty pram for experimental purposes.

As usually happens on these occasions, the child was a model of perfect behaviour just as was the case with the wireless receiver many years ago when I went along to a certain radio society to demonstrate the evils of instability. However, I soon succeeded in provoking the child into violent and highly damped vocal oscillation by prodding it in the ribs with my umbrella, and it was then that I switched on the "baby car radio" which I had spent the night in installing in the false bottom of the pram. The effect was magical, and, as I had anticipated, not

only were the infant's vocal oscillations speedily damped out, but the nursemaid's boredom was soon vanquished by the soothing sobs of a Luxembourg crooner, and before long I had a whole crowd of interested nursemaids surrounding me.

This first day of the Show has therefore been spent in conveying parties of the leading set manufacturers to and from Kensington Gardens, with the result that they are surrounding me as I write, vociferously demanding the manufacturing rights of my Radiogram, which I claim is going to be the salvation of the radio industry, as it opens up an entirely new

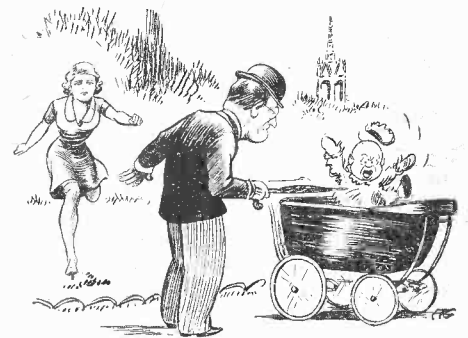

Highly damped oscillation.

field of manufacture. I am endeavouring to arrange to have a pram equipped with my baby car radio on view at Olympia to-morrow and on the subsequent days of the Show, but I cannot at present tell you the stand number, as I don't know it myself yet. However, an enquiry made at *The Wireless World* stand will enable you to learn its whereabouts.

A Fundamental Error

I MUST confess that I have been greatly intrigued with the B.B.C.'s demonstrations of the quality obtainable with a modern set and with that given by one of a few years ago. In fairness to these old-time sets, however, I think I ought to point out that the great gulf between the quality they give and that churned out by the modern ones is not really as wide as might be thought by those not accustomed to reason these matters out so thoroughly as myself. The great point that is forgotten is that the B.B.C.'s transmissions of a few years ago were also of much poorer quality than is the case to-day, and had an old-time set been able to have had the same quality transmissions as its modern counterpart gets, it would have sounded much better than it used to, or, to put it the other way, were a modern set fed with the transmitted quality of a few years ago it would not sound nearly so good as it does. There is one great omission in this demonstration, and that is that the B.B.C. make no attempt to demonstrate the quality that will be available from the sets of ten years hence.

For that little extra sensitivity —
and that little extra top response —
that slight extra forwardness —
that slight extra smoothness —
which make such a BIG difference —

Get a

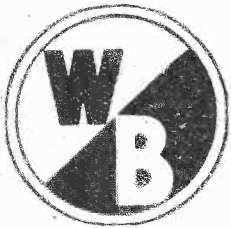

Stentorian

The Universal Permanent Magnet Speaker

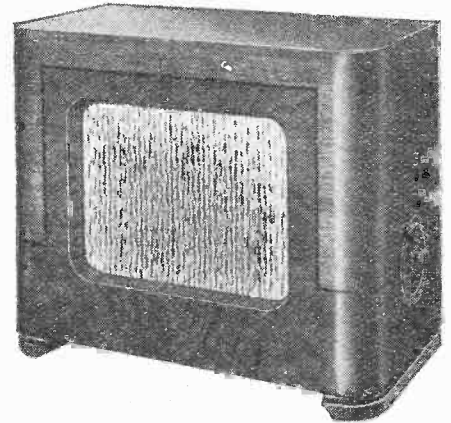

PRICES
Cabinet Models

Handy "X"	19. 6
Baby	£1. 9. 6
(now with volume control)	
Cadet	£1. 19. 6
Junior	£2. 9. 6
Senior	£3. 3. 0
Regent	£5. 5. 0
Emperor	£7. 7. 0

Chassis from 17s. 6d.

WHITELEY ELECTRICAL RADIO CO., LTD., RADIO WORKS, MANSFIELD, NOTTS.

"The Complete Component Guide"

128 PAGE NEW EDITION, with revised, tabulated, and fully illustrated sections, covering thousands of components for use in modern radio and television construction. Packed full with technical and dimensional data.

Bulgin Products are essential for the "Pre-tuned Quality Receiver"; only the best is specified. Buy Bulgin — AND BE SURE.

THE HANDBOOK OF THE INDUSTRY—YOU CANNOT AFFORD TO BE WITHOUT IT.

VISIT OUR



A. F. BULGIN & Co., Ltd.,
Abbey Road,
Barking, Essex.
Telephone:
RIPpleway 3474.



Send Coupon NOW

I enclose 3d. stamps; please send me the New 128 page Bulgin Catalogue No. 162.

NAME

ADDRESS

W.W. 24/8/39.

CLASSIFIED ADVERTISEMENTS

NOTICES

THE CHARGE FOR ADVERTISEMENTS in these columns is

12 words or less, 3/- and 3d. for every additional word.

Each paragraph is charged separately and name and address must be counted.

SERIES DISCOUNTS are allowed to Trade Advertisers as follows on orders for consecutive insertions, provided a contract is placed in advance, and in the absence of fresh instructions the entire "copy" is repeated from the previous issue: 13 consecutive insertions 5%, 26 consecutive, 10%; 52 consecutive, 15%.

ADVERTISEMENTS for these columns are accepted up to **FIRST POST** on **MONDAY MORNING** (previous to date of issue) at the Head Offices of "The Wireless World," Dorset House, Stamford Street, London, S.E.1, or on **SATURDAY MORNING** at the Branch Offices, 8-10, Corporation Street, Coventry; Guildhall Buildings, Navigation Street, Birmingham, 2; 260, Deansgate, Manchester, 3; 26a, Renfield Street, Glasgow, G.2.

Advertisements that arrive too late for a particular issue will automatically be inserted in the following issue unless accompanied by instructions to the contrary. All advertisements in this section must be strictly prepaid.

The proprietors retain the right to refuse or withdraw advertisements at their discretion.

Postal Orders and Cheques sent in payment for advertisements should be made **& Co.** payable to **ILIFFE & SONS Ltd.**, and crossed **& Co.** Notes being untraceable if lost in transit should not be sent as remittances.

All letters relating to advertisements should quote the number which is printed at the end of each advertisement and the date of the issue in which it appeared.

The proprietors are not responsible for clerical or printers' errors, although every care is taken to avoid mistakes.

NEW RECEIVERS AND AMPLIFIERS

*

*

CHALLENGER RADIO CORPORATION "Degallier's." Send 2d stamp for handsome illustrated catalogues telling of our superb range of 1940 fully guaranteed receivers; direct to public sales policy saves you 40%; sets to suit every pocket from 65/- to £31/10. Sale list also available upon request.—Challenger Radio Corporation, "Degallier's," 31, Craven Terrace, London, W.2. Paddington 6492. Nearest point, Lancaster Gate Tube. [8731]

R

RADIO CLEARANCE, Ltd., 63, High Holborn, London, W.C.1. Phone: Holborn 4631.

GUTHNAN MCMURDO Silver Super Silver Communication Receiver.

AS Described in Previous Issue of This Magazine. Circuit, superhet, double regeneration obtained at signal frequency and also at intermediate frequency, as a result very high sensitivity and selectivity are obtained; controls include R. meter, silencer, tone, aerial trimmer, A.F. gain selectivity, beat oscillator, receive-send, A.V.C., B.F.O., on-off, B.F.O. pitch, assembled with valves but unwired, £17; wired and aerial tested, £18/18.

AMAZING Offer for One Month Only.

BRITISH Belmont 9-valve A.C. Superhet Chassis, complete with Mullard valves, four wave bands, covering 6-2,000 metres, complete with escutcheon and all necessary parts for fixing into cabinet, £57/6 each; complete in De Luxe cabinet with speaker, £77/7; speaker matched for use with above chassis available at 15/- each extra.

RADIO CLEARANCE, Ltd., 63, High Holborn, London, W.C.1. Phone: Holborn 4631. [8786]

ARMSTRONG Co.—After many years at our old premises at Camden Town we have moved to a new building in Writers Rd., Holloway, N.7 (see displayed advertisement).

ARMSTRONG Amplifier Division Has Removed to New Premises at 94, Camden Rd., N.W.1. In addition to our standard range of 6- and 12-watt push-pull high fidelity amplifiers and local station feeder units, we manufacture equipment for special purposes, pre-stage units, electronic mixers, tone control units, etc.

ARMSTRONG Are Always Pleased to Assist in the Solution of Special Problems; details of standard equipment free on request.

ARMSTRONG Co. (Amplifier Division), 94, Camden Rd., N.W.1. [8752]

AMAZING Offer.—Famous 7-valve push button 1939 models in maker's sealed cartons, issued 13½ gns.; £5/19/6; list free.—Shippers, 18, Corporation St., Manchester. [0639]

£5/15—Ambassador 6778 Universal 7-valve chassis and speaker (10in.), four band, R.F. stage; a few only, being surplus production, at this low price; cash with order, money refunded if not genuinely satisfied.—Ambassador Radio Works, Hutchinson Lane, Brighouse, Yorks. [8812]

ARMSTRONG

QUALITY YEAR

The age of "gadgets" has passed. To-day the marvel of radio has become commonplace through use and familiarity. In our opinion there is a vital reason for purchasing a new set—Quality! Since last season we have worked exclusively to this end and believe with these new chassis we have achieved our objective.

—OUR NEW 1940 CHASSIS—

include the following:

SUPERHET - STRAIGHT 10 - VALVE ALL-WAVE HIGH FIDELITY RADIOGRAM. MODEL SS10

incorporating Two Independent Circuits, Superheterodyne and Straight, having R.F. Pre-amplifier and R.C. Coupled Push-Pull Triode Output capable of handling 8 watts.

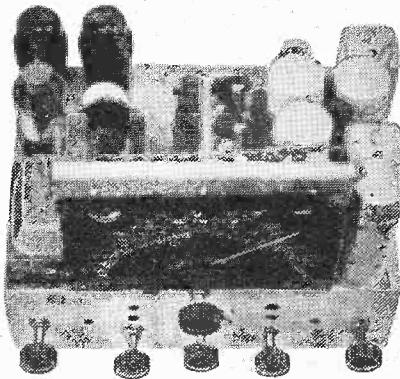

The circuit of the SS10 is unique. When used as a STRAIGHT receiver two HF stages are in operation with A.V.C. Diode Detector is used for distortionless detection together with Triode Push-Pull output. A turn of only one knob is necessary to switch from "Superhet" to "Straight." The Gramophone Amplifier has been specially studied and records can be reproduced with excellent 12 gns. quality.....

SEE AND HEAR THEM ON STAND 69 RADIOLYMPIA

MODEL SS2B—10-V SUPERHET-STRAIGHT 2-WAVEBAND HIGH FIDELITY RADIOGRAM

This model has all the outstanding features of the SS10, the circuit being identical in every respect, except that the chassis is designed for Broadcast bands only, no provision being made for Short Waves. It has the same extremely lively performance on "Superhet" and high quality reproduction on "Straight"..... 11 gns.

MODEL AW38—8-V ALL-WAVE SUPERHET

This radiogram chassis has R.C. Coupled Push-Pull Output capable of handling 6 watts. This being our Quality Year we have carefully studied the design of our more economically priced models and it's now possible for those requiring 8 gns. quality with economy to satisfy their desire. 8 gns.

MODEL AW125PP—12-V 5-BAND ALL-WAVE RADIOGRAM (12-550 continuous, 1000-2000 m.)

with R.F. Pre-Amplifier, 2 I.F. stages with Variable Selectivity, Manual R.F. gain control and 10 watts R.C. coupled Triode P.P. Output.

Readers need no introduction to this most popular model, so favourably reviewed by *The Wireless World* on Jan. 5th last. Basically, it remains the same but the frequency response has been still further improved to conform to the higher standard of quality 17 gns. we have set ourselves this year.....

Illustrated Art Catalogue giving full specification and details of our 8 Models will be sent upon request.

All chassis on 7 days' approval, carriage paid. 12 MONTHS' GUARANTEE.

ARMSTRONG MANUFACTURING CO.
WALTERS ROAD, HOLLOWAY, LONDON, N.7.
(Adjoining Holloway Arcade.) Phone: NORTH 3213.

NUMBERED ADDRESSES

For the convenience of private advertisers, letters may be addressed to numbers at "The Wireless World" Office. When this is desired, the sum of 6d. to defray the cost of registration and to cover postage on replies must be added to the advertisement charge, which must include the words Box 000, c/o "The Wireless World." All replies should be addressed to the Box number shown in the advertisement, c/o "The Wireless World," Dorset House, Stamford Street, London, S.E.1. Readers who reply to Box No. advertisements are warned against sending remittances through the post except in registered envelopes: in all such cases the use of the Deposit System is recommended, and the envelope should be clearly marked "Deposit Department."

DEPOSIT SYSTEM

Readers who hesitate to send money to advertisers in these columns may deal in perfect safety by availing themselves of our Deposit System. If the money be deposited with "The Wireless World," both parties are advised of its receipt.

The time allowed for decision is three days, counting from receipt of goods, after which period, if buyer decides not to retain goods, they must be returned to sender. If a sale is effected, buyer instructs us to remit amount to seller, but if not, seller instructs us to return amount to depositor. Carriage is paid by the buyer, but in the event of no sale, and subject to there being no different arrangement between buyer and seller, each pays carriage one way. The seller takes the risk of loss or damage in transit, for which we take no responsibility. For all transactions up to £10, a deposit fee of 1/- is charged; on transactions over £10 and under £50, the fee is 2/6; over £50, 5/-. All deposit matters are dealt with at Dorset House, Stamford Street, London, S.E.1, and cheques and money orders should be made payable to Iliffe & Sons Limited.

SPECIAL NOTE.—Readers who reply to advertisements and receive no answer to their enquiries are requested to regard the silence as an indication that the goods advertised have already been disposed of. Advertisers often receive so many enquiries that it is quite impossible to reply to each one by post. When sending remittances direct to an advertiser, stamp for return should also be included for use in the event of the application proving unsuccessful.

USED SETS FOR SALE

PHILCO

1938 Philco 6-valve All-wave, A.C.-D.C., new valves; £5 nearest.—Alison, 64, Syon Lane, Isleworth, Middlesex. [8834]

HALLICRAFTER

HALLICRAFTER Sky Champion; first £10, bargain.—Procter, 7, Arnelife Terrace, Northallerton. [8833]

CAR RADIO

1939 Models from 4½ gns., 6 new car aerials, from 9/6; trade enquiries solicited; lists free.—Shippers, 18, Corporation St., Manchester. [0622]

PUBLIC ADDRESS

V

VORTEXION P.A. Equipment.

IMITATED, but unequalled.

WE Invite You to a Demonstration.

A.C.-D.C. Dance Band Amplifier, 10 watts output, complete in case, with moving coil microphone, speaker and cables, weight 22lb.; 12 gns.

A.C. 20 15-20-watt Amplifier, 38-18,000 cycles, independent mike and gram. inputs and controls, 0.037 volts required to full load, output for 4, 7.5, and 15 ohms speakers, or to specification inaudible hum level, ready for use; 8½ gns., complete.

C.P. 20 12-volt Battery and A.C. Mains Model, as used by R.A.F., output as above; 12 gns.

A.C. 20, in portable case, with Collard motor, Piezo pick-up, etc., £14; C.P. 20 ditto, £17/17.

50 WATT Output 6L6s, under 60-watt conditions, with negative feed back, separate rectifiers for anode screen and bias, with better than 4% regulation level response, 20-25,000 cycles, excellent driver, driver transformer, and output transformer matching 2-30 ohms impedance electronic mixing for mike and pick-up, with tone control, complete with valve and plugs; £15.

COMPLETE in Case, with turntable, B.T.H., Piezo pick-up and shielded microphone transformer; £20.

80 WATT Model, with negative feed back; £25, complete.

120 WATT Model, with negative feed back; £40, complete.

250 VOLT 250 m.a. Full Wave Speaker field supply unit; 25/-, with valve.

ALL P.A. Accessories in Stock; trade supplied.

VORTEXION, Ltd., 182, The Broadway, Wimbledon, S.W.19. Phone: Lib. 2814. [8241]

VORTEXION 15W

Type CP20 AC and 12-VOLT DC AMPLIFIER

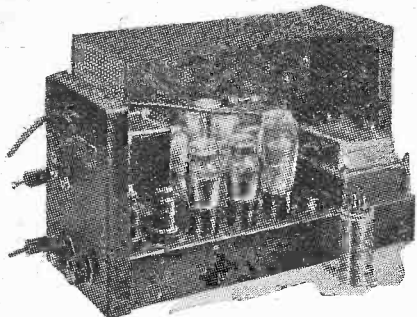

THIS small Portable Amplifier, operating either from AC mains or 12-volt battery, was tested by "THE WIRELESS WORLD," October 1st, 1937, and has proved so popular that at Customers' demand it remains unaltered except that the output has been increased to 17.2 watts and the battery consumption lowered to 6 amperes. Read what "The Wireless World" said:—
"During tests an output of 14.7 watts was obtained without any trace of distortion so that the rating of 15 watts is quite justified. The measured response shows an upper limit of 18,000 c/s and a lower of 30 c/s. Its performance is exceptionally good. Another outstanding feature is its exceptionally low hum level when AC operated even without an earth connection. In order to obtain the maximum undistorted output, an input to the microphone jack of 0.037 volt was required. The two independent volume controls enable one to adjust the gain of the amplifier for the same power output from both sources, as well as superimpose one on the other, or fade out one and bring the other up to full volume. The secondary of the output transformer is tapped for loudspeakers or line impedances of 4, 7.5 and 15 ohms."

- AC and 12-volt CHASSIS with valves, etc. £12 12 0
- Or in Rexine Case with Collaro Motor, Piezo P.U. and Mike Transformer..... £17 17 0
- AC only CHASSIS with valves, etc. £8 18 6
- Or in Rexine Case with Collaro Motor, Piezo P.U. and Mike Transformer..... £14 0 0

Gauge Case for either chassis 12/6 extra.
We are 25 minutes from Olympia and can give full demonstrations of any model.

CALL AND SEE US!

Vortexion Ltd., 182, The Broadway, Wimbledon, S.W.19. Phone: LI Berty 2814.

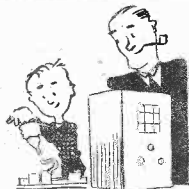

Said Smith to his lad, "For your set I'm glad you use FLUXITE and yet—
Don't smother it, son, Just a spot from the gun Gives the finest results, don't forget!"

See that FLUXITE is always by you—in the house—garage—workshop—wherever speedy soldering is needed. Used for 30 years in Government works and by leading engineers and manufacturers. Of Ironmongers—in tins, 4d., 8d., 1/4 and 2/8. Ask to see the FLUXITE SMALL-SPACE SOLDERING SET—compact but substantial—Complete with full instructions, 7/6. Write for Free Book on the art of "SOFT" SOLDERING—and ask for leaflet on CASE-HARDENING STEEL and TEMPERING TOOLS with FLUXITE.

TO CYCLISTS! Your wheels will NOT keep round and true unless the spokes are tied with fine wire at the crossings AND SOLDERED. This makes a much stronger wheel. It's simple—with FLUXITE—but IMPORTANT

THE FLUXITE GUN

is always ready to put Fluxite on the soldering job instantly. A little pressure places the right quantity on the right spot and one charging lasts for ages. Price 1/6 or filled 2/6.



ALL MECHANICS WILL HAVE

FLUXITE

IT SIMPLIFIES ALL SOLDERING

FLUXITE LTD., Dept. W.W., DRAGON WORKS, BERMONDSEY ST., S.E.1

PUBLIC ADDRESS

TANNOY 25-watt Amplifier, Ad-on-Unit, A.C. mains, complete; £10.—Easco, 18w, Brixton Rd., S.W.9. [0643]

"PARTRIDGE P.A. Manual," free to trade, from N. Partridge, B.Sc., A.M.I.E.E., King's Buildings, Dean Stanley St., London, S.W.1. [0631]

ALEXANDER BLACK, Ltd.—Consult us on sound installations, temporary or permanent; booklet on request.—55, Ebury St., S.W.1 Sloane 6129. [0597]

PUBLIC Address Contractors Can Hire P.A. Vans, loud speakers, microphones and equipments of all types from Hire Dept., Gramplan Reproducers, Ltd., New Gardens, Surrey. Tel.: Richmond 1175-6-7. [0618]

NEW MAINS EQUIPMENT

VORTEXION Mains Transformers, chokes, etc., are supplied to G.P.O., B.B.C., L.P.T.B. Why not you?

VORTEXION, Ltd., 182, The Broadway, Wimbledon, London, S.W.19. Telephone: Liberty 2814. [8772]

NEW LOUD-SPEAKERS

SINCLAIR Speakers for All Types.—Pulteney Terrace, Copenhagen St., N.1. [0603]

BAKERS New Corner Horn Speakers, triple cone versions; from 29/6, and surplus speaker bargains.—Bakers Selhurst Radio, 75, Sussex Rd., South Croydon. [8728]

SAVE Pounds.—1½d. stamp for list British and American P.A. Speakers. Example: P.A. unit with transformer weighing 23lb., incorporating curved cone, 47/— Degallier's, 31, Craven Terrace, London, W.2. [8814]

LOUD-SPEAKERS

SECOND-HAND, CLEARANCE, SURPLUS, ETC.

3,000 Speakers from 5/6 each, P.M. and energised 4in. to 14in. including several Epoch 18in.—Sinclair Speakers, Pulteney Terrace, Copenhagen St., N.1. [0591]

TRANSMITTING APPARATUS

A.C.S. RADIO, specialists in short wave apparatus, communication receivers, including Hallierafter's, National and R.M.E. transmitting equipment, valves and components. Send for free catalogue to A.C.S. Radio, 16, Gray's Inn Rd., W.C.1. Holborn 9894-5. G2NK, Technical Manager. [0550]

G5N1—The oldest and largest distributor of amateur equipment transmitting and receiving; short-wave catalogue, 1½d. G5N1 70-page Manual, 7½d., post free; authorised direct distributor for Collins, National, R.M.E., Thordarson, Hammerlund, Biley, Taylor, Elmec, etc., etc.—44, Holloway Head, Birmingham. [0531]

CABINETS

A CABINET for Every Radio Purpose.

CONVERT Your Set into a Radiogram at Minimum Cost; surplus cabinets from noted makers under cost of manufacture (undrilled); 30/- upwards; motors at wholesale prices.

"FIVE-A-GRAM" Cabinet, 31x17x15, 21/—

UNDRILLED Table Console and Loud-Speaker Cabinets from 3/6.

INSPECTION Invited; photos loaned to country customers.

H. L. SMITH and Co., Ltd., 289, Edgware Rd., W.2. Tel.: Pad. 5891. [0485]

DEGALLIER'S for the Finest Obtainable American Cabinets, Table, Console and Radio Grams; also Record Changers, 5 gns. Send 1½d. stamp for reprints from actual photog apts.—Degallier's, 31, Craven Terrace, Lancaster Gate, London, W.2. Paddington 6492. [8815]

DYNAMOS, MOTORS, ETC.

CONVERTER, D.C. 240, input A.C. 230, output 120w. Gul. perfect; 65/—Collins, 15, Camden Sq., N.W.1. [817] 2141.

ALL Types of Rotary Converters, electric motors, battery chargers, petrol-electric generator sets, etc., in stock, new and second-hand.

A.C.D.C. Conversion Units for Operating D.C. Receivers from A.C. Mains, 100 watts output, £2/10; 150 watts output, £3/10.

WARD, 46, Farringdon St., London, E.C.4. Tel.: Holborn 9703. [0518]

M.L. Rotary Converter, as new, complete with smoothing outfit, 24 volts D.C., 230 volts A.C. output; cost £18, accept £9.—Wise, 95, West Av., Bath. [8818]

ELECTRADIX Rotary Converters for A.C. Radios on D.C. Mains; alternators, 50 to 500 cycles; mains motors and motor generators for 1 to 600 cells; petrol engines and switchgear.—218, Upper Thames St., London, E.C.4. [0619]

RECORDING EQUIPMENT

ALL Recording Discs and Materials in Stock, tracker units, £47/7/6; recording motors, £3/17/6.—Write for further details, Will Day, Ltd., 19, Lisle St., W.C.2. [0595]

Get your new ARMSTRONG CHASSIS

ON L.R.S EASY TERMS

After thorough tests we can fully endorse all Messrs. Armstrong claim for their new MODEL SS10

SUPERHET-STRAIGHT 10-V ALL-WAVE RADIOGRAM CHASSIS

(See advt. opposite page)
At the turn of a switch this chassis has the unrivalled quality of a STRAIGHT set and the far-reaching capabilities of the most sensitive SUPERHET.

Unless something revolutionary in radio technique is unexpectedly developed, we are convinced that this set will remain an outstanding leader for a very long time and will prove to be a good investment

CASH or C.O.D. Price 12 guineas or 27/- with order and 12 monthly payments of 18/4.

Illustrated literature giving full particulars of all models will be sent free upon request, with details of our convenient terms.

FULL RANGE IN STOCK. WRITE TO-DAY!

In addition to the Armstrong range, we shall be glad to quote for all other high grade equipment, such as Sound Sales Amplifiers, Voigt Speakers, Haynes Radio, Avometers, etc.

Estd. — 1925 THE LONDON RADIO SUPPLY COMPANY Phone NATIONAL 6828
11-OAT LANE · NOBLE ST · LONDON EC2

CABINETS For Quality Reproduction

In designing the Lockwood Model A.D.500 Radiogram Cabinet, illustrated below, we gave careful consideration to satisfying both the ear and eye. The result is excellent acoustic properties and an appearance which can only be obtained by experienced workmanship.

Those who desire efficient accommodation for their Quality Receiver will be interested in the following features:—

- SLOTTED SIDES to prevent box resonance.
- SLOPING BAFFLE lifts sound to ear level.
- REMOVABLE LINEN-COVERED BACK & OPEN BOTTOM gives free outlet and adequate ventilation.
- CROSS BATTENED PANELS 3/4" THICK gives greater efficiency than thicker panels without battens.
- FELT-LINED HINGED LID forms sound-proof joint between lid and cabinet.

There is ample space for all "Wireless World" sets or any combination of commercial chassis, speaker, radiogram unit, etc. In Oak, Mahogany or Walnut. 6GNS.

All Lockwood Cabinets have choice matched veneer panels, are hand made and hand polished to any desired finish in high gloss or semi-dull.

Demonstrations arranged by appointment. Send postage 1½d. for details.

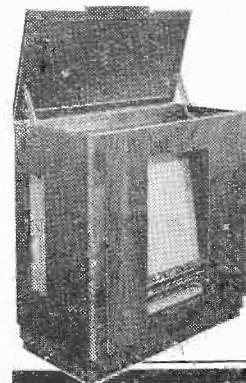

SPECIAL DESIGNS

State your requirements and we shall be glad to prepare special drawings FREE OF CHARGE.

LOCKWOOD & CO.

Designers & Makers of Fine Furniture. 65 LOWLANDS ROAD HARROW, MIDDLESEX. Phone: BYRON 1818.

M.R. SUPPLIES for Exclusive Modern Bargains

Once again we are able to offer a parcel of **FIRST-CLASS PUBLIC ADDRESS, RADIO AND ELECTRICAL MATERIAL AT BARGAIN PRICES.** Discriminating buyers will note with interest that these offers include



material, the design, construction and finish of which is far above ordinary commercial standards. Every article brand new unless otherwise stated.

G.E.C. 1582 High-quality "All-purpose" POWER AMPLIFIERS. For microphone, gramophone and radio inputs. Operation 200/250 v. A.C. Input transformers for M/Coil or Carbon mike (interchangeable)—please state which required. Response 50/10,000 c/s. Output matching 1.5, 2.5, 3, 7.5, 15 and 600 ohms. Closed chassis form, overall 4 1/2 in. x 8 1/2 in. x 10 in. Complete with four Osram valves (PX25 output). Listed £20. We offer 15 only at £10/- each. Having an output of 6/8 watts, these engineer-built amplifiers are perfect for domestic or professional use. Early reservation essential. Also a limited quantity of the appropriate **PORTABLE CABINETS** for the above, polished oak with wire mesh front, 19 1/2 in. each.

G.E.C. 1545 SCHOOL OR HOSPITAL RECEIVERS. Universa A.C./D.C. Superhet in fine oak cabinet, 20 in. x 12 1/2 in. x 8 1/2 in. Laboratory-built to rigid specification and delivering 6 watts high-fidelity output. Officially approved for School Broadcasting and ideal for all communal and domestic reception. Multi-matching output for up to five speakers or 400 pairs' phones. Station name dial, 200/2,000 metres. Complete with 7 Osram valves (2xN21 output), in maker's sealed transport case. (Current list £24.) Really exceptional offer at only £7/10/-.

G.E.C. 1575 MICROPHONES. £7/10/- Transverse Current Model, in fine bronze case, 4 in. x 4 in. x 2 in. Very wide frequency response—high sensitivity. 20/3.

G.E.C. MICROPHONE TRANSFORMERS. Fully shrouded, 4 in. x 4 in. x 2 1/2 in., with plug-type terminals and appropriate as spares to 1582 Amplifiers (above). Suited to any microphones. Model 1576 for all Carbon mikes, 6/6. Model 1581 for all M/Coil mikes, 7/11.

G.E.C. POWER PACKS (or A.C. Eliminators). Delivering 250 v. 55 m.a. and 4 v. 4 a. A.C. Ideal for Preslin stage, field excitation etc. Complete with U10 Rectifier, in steel cabinet, 8 in. x 8 in. x 5 1/2 in. (Listed over £6). Last few at 2/- each, complete.

G.E.C. GRAMOPHONE PICK-UPS. One of the most efficient armature type pick-ups ever made. Fine response, large output and very light on records. Complete with 12 in. x 12 in. high with control opening cut 3 1/2 in. x 7 in. Heavy gauge steel with back brackets, 5/9.

PANEL METERS. (As reviewed in "W.W." of 27/7/39.) Report: "Neat and accurate—each hand calibrated—when checked against a sub-standard the agreement was as close as pointer could be read." A.C./D.C. spring-controlled M/Iron, 2 in. dia. Finished semi-dull black. Amperes: 0/1, 0/3, 0/5 or 0/10, any one 5/6. Volts: 0/10, 0/11, 0/250, 7/6.

WHARFOLD MIC/COIL MICROPHONES. Fine response and sensitivity. 15 ohms imp. Diameter 4 1/2 in., depth 2 1/2 in. Finished black and chromium, 35/-.

ELECTRIC CLOCKS. We only offer utterly reliable bargains. British-made Sterling mantel model in polished oak case with square silvered dial. Height 6 in. We have 150 only of the 29/6 model, which we offer at only 12/9 each. Also same style in strong buzzer alarm model at 14/11. This is a great opportunity, first-class movement alone worth more.

ZENITH FIXED RESISTORS. Vitreous 388 ohms, with tap of 83 ohms, capacity 60 watts. On asbestos base with perforated box cover, 5 1/2 in. x 2 1/2 in. x 2 1/2 in. Designed and ideal for dropping volts for 100/120 v. receivers in place of line cord, 3/9.

PUSH-BUTTON SWITCHES (Illustrated). Banks of 6 D.P. switches with mounting brackets, 4 1/2 in. wide. Fine positive make and release. Also suitable for model railways, remote control, etc., 2/11.

ELECTRIC MOTORS. Finest possible make and type—"Century" brand new 1/4th h.p. repulsion-induction self-starting, 1,450 r.p.m., standard 1/4 in. shaft. Overall length 10 1/2 in., fitted slotted mounting feet. Silent running, heavy duty, high torque (List £4/18/6), 100/220 volts A.C., 42/6 each. Not to be confused with cheap Continental motors made down to a price. Also a range of same make in D.C. Motors from 1/8th to 1 h.p.—please enquire.

CONVERTERS (Retary). All as new Janette, input 220/220 v. D.C., output 110 v. A.C., 750 watts (very fine machine, listed at £22). £6/10/- (curr. forward). E.D.C., input 220/220 v. D.C., output 220 v. A.C., 1,000 watts (List £27), one only at £17/17/6. Westinghouse, input 110/115 v. D.C., output 110 v. A.C., 500 watts, portable type with carrying handle, £5/10/-, step-up transformers to suit (if required), 120 watts, 17/6; 250 watts, 27/6; 400 watts, 37/6; 750 watts, 49/6.

RADIO INTERFERENCE SUPPRESSORS. (Illustrated.) Twin wave-form wound H.F. Chokes and 1 x 1 m.f., 400 v. w.g. Condenser. Simple installation as shown—diagram included. Definitely eliminates all interference introduced through house mains, 3/3 complete.

EDISWAN TUNGAR BATTERY CHARGERS. Operation A.C. 200/250 v. Complete unit with rectifier and barreters in steel cabinet, 18 in. x 9 1/2 in. x 8 1/2 in., fitted 0/8 Ammeter. Charges any voltage from 2 to 120 volts at from our previous parcel to the Services.

SLOW-MOTION CONDENSER DRIVES. Standard 1/2 in. socket and spindle, overall length 2 1/2 in., ratio 7/1. Very fine action, 1/- each.

BRUSH PIEZO-CRYSTAL ELEMENTS. Unusual offer at under one-half net cost of importation (see illustration). 2 1/2 in. diameter, fitted stylus. For construction of high-fidelity Microphone, Pick-up, Cardiophone, Tweeter, etc., 6/11.

AMPLIFIERS. We claim to have the best bargains in high-class equipment. Examples:—"Truvoice" Model TU16, A.C./D.C., output 16 watts. With gram-playing deck fitted crystal p.u., m/coil mike and floor stand, new (List approx. £30), four only at £12/17/6. "Shaftesbury" Paragon, A.C./D.C., output 6/8 watts, with mike and floor stand, portable, with speaker (List £16/10/-), seven only at £8/17/6.

Order now from the firm which never disappointed a customer—

M.R. SUPPLIES, 68, New Oxford Street, London, W.C.1. (Telephone: MUSeam 2958)

to 5 amps. Ideal garage or professional charger. List 12 gns. We have a few, slight showroom-soiled, at only £4/15/- each.

CROSLY MOBILE 6-VALVE SUPERHET CHASSIS. Operating entirely from 6-volt car battery, taking only 2 amps. Tuned 15 to 555 metres in 3 bands. Output 3 watts. Five-colour 7 in. dial. Complete with speaker and all valves. Ideal for caravan, boat or our previous parcel to the Services.

P.A. Wonderful bargain, £5/10/-. We sold a large number from our previous parcel to the Services.

EDISWAN TUNGAR BATTERY CHARGERS. Operation A.C. 200/250 v. Complete unit with rectifier and barreters in steel cabinet, 18 in. x 9 1/2 in. x 8 1/2 in., fitted 0/8 Ammeter. Charges any voltage from 2 to 120 volts at from our previous parcel to the Services.

SLOW-MOTION CONDENSER DRIVES. Standard 1/2 in. socket and spindle, overall length 2 1/2 in., ratio 7/1. Very fine action, 1/- each.

BRUSH PIEZO-CRYSTAL ELEMENTS. Unusual offer at under one-half net cost of importation (see illustration). 2 1/2 in. diameter, fitted stylus. For construction of high-fidelity Microphone, Pick-up, Cardiophone, Tweeter, etc., 6/11.

AMPLIFIERS. We claim to have the best bargains in high-class equipment. Examples:—"Truvoice" Model TU16, A.C./D.C., output 16 watts. With gram-playing deck fitted crystal p.u., m/coil mike and floor stand, new (List approx. £30), four only at £12/17/6. "Shaftesbury" Paragon, A.C./D.C., output 6/8 watts, with mike and floor stand, portable, with speaker (List £16/10/-), seven only at £8/17/6.

Order now from the firm which never disappointed a customer—

M.R. SUPPLIES, 68, New Oxford Street, London, W.C.1. (Telephone: MUSeam 2958)

to 5 amps. Ideal garage or professional charger. List 12 gns. We have a few, slight showroom-soiled, at only £4/15/- each.

CROSLY MOBILE 6-VALVE SUPERHET CHASSIS. Operating entirely from 6-volt car battery, taking only 2 amps. Tuned 15 to 555 metres in 3 bands. Output 3 watts. Five-colour 7 in. dial. Complete with speaker and all valves. Ideal for caravan, boat or our previous parcel to the Services.

P.A. Wonderful bargain, £5/10/-. We sold a large number from our previous parcel to the Services.

EDISWAN TUNGAR BATTERY CHARGERS. Operation A.C. 200/250 v. Complete unit with rectifier and barreters in steel cabinet, 18 in. x 9 1/2 in. x 8 1/2 in., fitted 0/8 Ammeter. Charges any voltage from 2 to 120 volts at from our previous parcel to the Services.

SLOW-MOTION CONDENSER DRIVES. Standard 1/2 in. socket and spindle, overall length 2 1/2 in., ratio 7/1. Very fine action, 1/- each.

BRUSH PIEZO-CRYSTAL ELEMENTS. Unusual offer at under one-half net cost of importation (see illustration). 2 1/2 in. diameter, fitted stylus. For construction of high-fidelity Microphone, Pick-up, Cardiophone, Tweeter, etc., 6/11.

AMPLIFIERS. We claim to have the best bargains in high-class equipment. Examples:—"Truvoice" Model TU16, A.C./D.C., output 16 watts. With gram-playing deck fitted crystal p.u., m/coil mike and floor stand, new (List approx. £30), four only at £12/17/6. "Shaftesbury" Paragon, A.C./D.C., output 6/8 watts, with mike and floor stand, portable, with speaker (List £16/10/-), seven only at £8/17/6.

VALVES

AMERICAN 2/9; 1,000 non-ring British from 1/9; bargain galore; lists free.—Shippers, 18, Corporation St., Manchester. [0607]

SPECIAL Line of Rogers and Majestic tubes, types 55L, 227, 551s, 55s, 6B7, 56, 458; 3/6.

ALL Types of American Tubes in Stock of Impex and Arcturus makes at competitive prices.

WE Can Also Supply a Full Range of Guaranteed Replacement Valves for Any British non-ring, American or Continental type at an appreciably lower price.

SEND for Lists of These, and also electrolytic condensers, line cords, resistances, etc.

CHAS. F. WARD, 46, Farringdon St., London, E.C.4. Tel.: Holborn 9703. [0452]

METROPOLITAN RADIO SERVICE.—Special offer, American valves, in makers' cartons, 3/- each, Octals, 3/6 each; American valves, first grade, in all types; trade supplied.—1021, Finchley Rd., N.W.11. Speedwell 3000. [0436]

TEST EQUIPMENT

MULLARD Master Test Board, unused, complete cards, etc.; offers or exchange lathe, tools, stock.—Pritchard, Radio, Menai Bridge, Anglesey. [8336]

Wanted

WANTED, L.F. oscillator, good make and condition.—Box 865, c/o *The Wireless World*. [8835]

COMPONENTS

SECOND-HAND, CLEARANCE, SURPLUS, ETC.

PREMIER SUPPLY STORES.

PLEASE SEE Our Displayed Advertisement on page 8. [0488]

RYALLS RADIO, 280, High Holborn, London, W.C.1. offer new goods, post free.

ELLIPTICAL Speakers, Celestion, suitable Ekco replacements, 750 and 1,250 ohms, less transformers, speech 25 ohms, new, handle 8 watts, carry up to 120 m.a.; 5/6 each.

AMPLIFIERS, A.C. 200-250v. output 16 watts A.C. From pair 6L6 push pull, 3 stage, ample volume for driving extra speakers available. Complete with valves, and pair of elliptical speakers, wired up ready for use; 7/6, carriage paid.

SPEAKERS, pairs, brand new, elliptical cone speakers, made by first class firm, quality of reproduction outstanding, push pull pentode transformer, fields 325 ohm for smoothing choke, 8,600 as bleeder, circuit available, handle 10-15w.; 14/- pair.

HEAVY Duty Mains H.F. Chokes, Goltone. 75w. high inductance type, 1/6; 120w. low inductance type, 1/-.

MAINS Transformers, drop through chassis type, top cover with mains adjustment, input 200-250v., outputs 350-350, 80 m.a. 4v. 2 1/2a. 4v. 4.5 amp., heavy jobs, 6/9 each.

MAGNAVOX 7in. Core Speakers (8in. overall), ribbed pattern ideal replacement speakers, 2,000 ohms pentode transformers; 7/-, new.

SATOR 1/2meg. Pcts with Switch, 1/3 each, 7/9 dozen; 10,000 ohm broad base tone control type, less switch, 1/3 each, 6/9 dozen.

AMPLIFIERS for A.C. 200-250v. Input, 3-stage single 6L6 output, with pair energised elliptical speakers, and Ferranti output transformer, output 12 watts; 47/6, all wired complete with valves and speakers. [8809]

COULPHONE RADIO, Ormskirk, for brand new 1939 receivers. 14-gn. Crossley 8-valve, 4 waveband; £6/10; 1 1/2d. stamp catalogues. [8837]

VAUXHALL—All goods as previously advertised still available; write for free list.—Vauxhall Utilities, 163a, Strand, W.C.2. [8727]

SOUTHERN RADIO, 46, Lisle St., London, W.C. Gerard 6653.—Stocks of receivers and replacement components, as previously advertised. [8542]

MAINS RADIO DEVELOPMENT COMPANY Offer Immediate Carriage Paid Delivery, call mornings Telephone Tudor 4046. Stamp for List 229.

MICA Tag Condensers, 0.0001 to 0.002 T.C.C., Ormond, etc., six different sizes in each parcel of twelve for 1/-; thirty for 2/-.

T.C.C. 8 mfd. 600v. Peak Metal Can Dry Electrolytics, one hole fixing, 2/3; T.C.C. midget tubular card ditto, 1/6.

ERIE One-watt Colour Coded Unused Resistors, any size, 50 ohms to 5 megohms, your selection, 3d., 2/6 dozen; two-watt, 6d.

CENTRALAB Latest Potentiometers, long standard spindle, unused, all sizes, 5,000 ohms to 2 megohms, 2/-; with switch, 2/3.

TUBULAR Condensers, 400v. working, wire ends, best make, 0.0001-0.05 mfd., 4d.; 0.1 mfd., 4d.; 0.25, 0.5 mfd., 6d.

CLIX Unused Chassis Valve Holders, 5-pin, 7-pin, 3d.; American sizes, 6d.; best sleeving, 1 1/2d. yard.

FIFTY Unused N.S.F. 1/2, 1, 2-watt resistors, wire ends, marked and colour coded, 20 different useful sizes in each parcel; 50 for 2/6

MAINS RADIO DEVELOPMENT COMPANY, 4-6, Muswell Hill Rd., London, N.6. Tudor 4046. [8778]

AMBASSADOR ALWAYS

FINEST PERFORMANCE & VALUE

Send for details

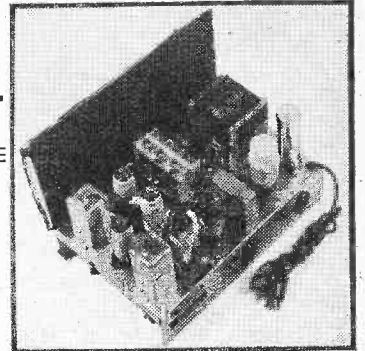

MODEL 6779

CASH PRICE

£11

with Valves and Speaker

A.C. ONLY

SPECIFICATION:

Six valve super-het chassis using MAZDA Octal valves. Powerful R.F. stage on all bands covering 12.5/52 metres, 175/550 metres, 1,000/2,000 metres. Large plate glass dial. Electrical Band Spreading. Sensitivity control. New High Speed A.V.C. Automatic distortion cancellation. Electro dynamic reproducer with 40/8,000 response. 6.8 watts output. Heavy plated chassis total weight 37 lbs.

Wholesale and Export Enquiries Invited

AMBASSADOR RADIO WORKS

HUTCHINSON LANE, BRIGHOUSE, YORKS

Telephone: 283

ELECTRADIX

TWO CLEAR SCALES with MIRROR are on the DIX-ONEMETER

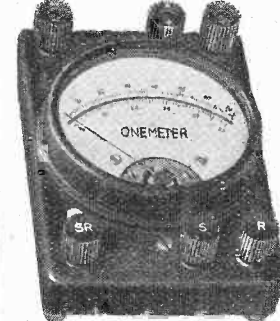

The Dix-Onemeter with only 6 Terminals, but 50 Range, is a valuable instrument for laboratory work. It is of portable size to go in the pocket, but big enough to cover the whole range of D.C. electrical measurements, 50 microamps, to 20 amps and 20 millivolts to 2,000 volts.

55/- ONLY

Multipliers from 6/8 each.

A further range of Meters is included in our advertisement on page 19.

HOME SOUND RECORDING at low cost.

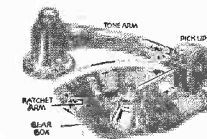

The FEIGH RECORDER fits any Radiogram, positive drive, worm gear and rack. Complete, ready for use, only 37/6. Super Feigh Fidelity Set, 42/6. Tracking Gear only, 21/-. Either 4/- dozen metal Banks can be used or the glass-coated simples, 10in. 3/- each. Pre-amplifiers for Recording Mikes, 1-valve Battery Model in cabinet, 25/- A.C. Mains pre-amplifiers, with valve rectifier, steel-cased model, 60/-.

PARCELS of experimental odd coils, magnets, wire, chokes, switches, terminals, etc., post free: 10 lbs., 5/-; 7 lbs., 4/-.

Over 1,000 other Bargains in our Illustrated 1938 List "W."

ELECTRADIX RADIOS

218, UPPER THAMES STREET, LONDON, E.C.4

Telephone: Central 4611

Pamphonic AMPLIFIERS

Pamphonic Reproducers Ltd. (Associated with P.Y.E. Ltd.)
45, St. Pancras Way, London, N.W.1.
Phone: EUston 1727.

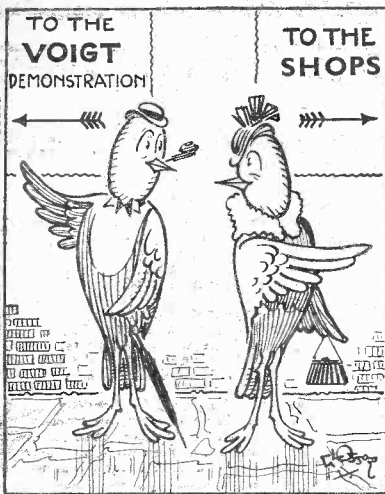

"Good-bye, my dear. I'm off to talk shop with the technical staff at Voigt's demonstration rooms."

We look forward to meeting Mr. Tit and our many other friends again at

2, BEACONSFIELD TERRACE ROAD

(Just opposite the Main Goods Entrance at back of Olympia)

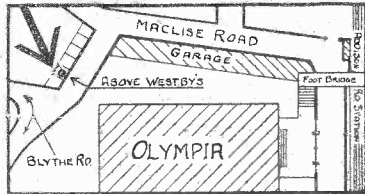

11 a.m. to 1, and 3 to 10.30 p.m. (i.e., 1/2 hour after Olympia closes)

Come and refresh your ears!



VOIGT PATENTS LTD

The Courts, Silverdale, London, S.E.26

Phone: SYDenham 6666.

Regd. Office: 22, Castle Street, E.C.1.

THE NORTHERN POLYTECHNIC,
HOLLOWAY ROAD, N.7.

Department of Musical Instrument and Radio Technology.

Head of Department: S. A. Hurren, M.I.R.E., F.I.W.T.

Day and Evening Courses in

RADIO SERVICING AND TELEVISION SERVICING

in preparation for all recognised qualifications in these subjects. Practical laboratory and workshop experience provided.

Prospectus free on application to Secretary.

New Term begins September 11th.

Evening Enrolment September 21st and 22nd.

BOOKS ON WIRELESS

Write for complete list to

Iliffe & Sons Ltd., Dorset House, Stamford St., London, S.E.1

W.W.1

COMPONENTS—SECOND-HAND CLEARANCE, SURPLUS, ETC.

- R. RADIO CLEARANCE, Ltd.**
63, High Holborn, W.C.1. Phone: Holborn 4631.
- FILAMENT Transformers.**—In put 200-250 volt, out put 4 volt, 4 amps., 4 volt 6 amps., 4/11 each.
- MAINS Transformers.**—American windings. In put 200-250 volt, tapped. Out put 350-0-350. 100 m.a. 5 volt 2 amp. 6.3 volt 5 amp.; 7/11 each.
- G.E.C. Mains Transformers.**—American windings. 350-0-350 volt. 65 m.a. 5 volt. 2 amp. 6.3 volt. 2.5 amps.; suitable for replacements in G.E.C. models; 5/6 each.
- AUTO Transformers.**—100-250 volt; 5/11.
- ELECTROLYTIC Condensers.**
- PLESSEY** 8x4x4x4 mfd. 570 volt working; 2/- each.
- PLESSEY** 24 mfd. Can type electrolytics, 450 volt working; 10d. each.
- T.C.C.** 8 mfd. Can type Wet Electrolytics, 450 volt working; 1/3 each.
- PLESSEY** Electrolytic Condensers, 8x8 mfd., 450 volt working; 1/- each.
- POLAR N.S.F.** Resistances.—1 gross parcels of 1/2 and 1/4 watt resistances, all good sizes, our selection; 4/6 each.
- PRESS** Button Units, with 6 press buttons ready for wiring into set, with circuit; 6/11 each.
- BULGIN.**—20,000 ohms wire wound pots; 1/- each.
- STRANDED** Push Back Wire; 1d. yd., 12 yds., 10d.
- YAXLEY** Switches.—2 pole, 4 way, 3 bank; 1/6 each.
- YAXLEY** Switches.—2 pole, 5 way, 4 bank; 2/- each.
- AMERICAN** Chassis Mounting Valve Holders.—4, 5, 6 and 7 pin; 3d. each.
- OCTAL** Chassis Mounting Valve Holders.—4d. each.
- 7-Pin** English Type Valve Holders. Chassis mounting; 2d. each.
- RAYTHEON** 76 Valves; 1/6 each.
- FULL** Range of Raytheon Valves in Stock.—Most competitive prices. For example:—
- 80**—2/9 each.
- 43**—4/- each.
- 6D6**—4/- each.
- 6C6**—4/- each, etc.
- SEND** for Complete Price List of Raytheon Valves.
- SET** of Three Manufacturers' Type All-wave Coils, 13-2000 metres, including oscillator, aerial and H.F., with three-gang straight condenser, 2/6 each; wave change switch for above, 2/- each.
- ROTHERMEL** Piezo Crystal Speakers.—7 1/2 in. cone; list 55/-, our price, 9/6 each.
- CO-AXIAL** Cable, finest quality, for television, lead in, etc.; single 6d. per yd., double 9d. per yd.
- HEAVY** Duty Speech Transformers, type O.T.4, primary 462 ohms, secondary 0.3, 20 henrys.
- TYPE** O.T.5, primary 487 ohms, secondary 0.7 ohms, 20 henrys; 2/11 each.
- RADIO** Clearance, Ltd., 63, High Holborn, London, W.C.1. Telephone: Holborn 4631.
- ALL** orders over 5/- carriage free; under this amount, sufficient postage must be included with order.
- ALL** Enquiries Must Enclose 1 1/2d. stamp. [8785]
- Wanted**
- WE** Buy for Cash All Types of Modern Second-hand Radio Sets and Accessories, test meters, parts, etc. We pay more than any other dealer. Part exchanges. Bring, send or will call.—University Radio, Ltd., 238, Euston Rd., London, N.W.1. Phone: Euston 3810. [8839]
- REPAIRS AND SERVICE**
- "SERVICE with a Smile."
- AMERICAN** Valves, spares, linecards, rewinds, repairs, of all types of American and British receivers.—E.R.L., Ltd., 22, Howland St., W.1. Museum 5675. [0434]
- LOUD-SPEAKER** Repairs, British, American, any make, 24-hours' service; moderate prices.—Sinclair Speakers, Pulteney Terrace, Copenhagen St., N.1. [0590]
- GUARANTEED** Repairs, Any Transformers, choke, motor armature, converter, dynamo, etc., keenest prices, immediate quotation, prompt, dependable service.—See below.
- L.T.P. (LONDON TRANSFORMER PRODUCTS, Ltd),** Willesden, N.W.10. Willesden 6486 (3 lines). [6892]

★ **FOR THIS WEEK ONLY**



LIMITED OFFER!

I have sold large numbers of the **PARTRIDGE P.A. MANUAL** at the published price of 2/6, and anticipate that many more will be sold in the future. But for **ONE WEEK ONLY** a special offer is being made. To every "WIRELESS WORLD" reader who sends me the coupon below a copy of the Manual will be posted free of charge. 40 pages packed with valuable information on Electro-Acoustics, Power Amplifiers, Partridge Control Circuit, Hum Elimination, Input and Output Circuits, Pre-Amplifiers, etc.

★ **POST THE COUPON TO-DAY!**

Now a word about my business

I design, build and sell Transformers and Chokes—nothing else. But this one activity is undertaken very seriously, in fact so seriously that we are acknowledged to be specialists in the true sense of the word. A transformer specialist must be conversant with the modern trend of receiver, amplifier and television design, and this necessitates much research and experimental work in these fields. From the wide experience gained over many years the **PARTRIDGE TECHNICAL SERVICE** is able to provide information and technical assistance to those engaged in Manufacturing and Public Address work.

MEN OF EXPERIENCE

Manufacturers, Service Engineers and Experimenters know that any trouble developing in a set or amplifier embodying **PARTRIDGE PERSONALLY-GUARANTEED PRODUCTS** will not be in the transformer or choke which are noted for their electrical and mechanical efficiency.

To **SET MANUFACTURERS** and the **TRADE**

We supply many large manufacturing firms and if you are interested we shall be glad to send full technical details and prices.



Send your enquiries to:—

N. Partridge

B.Sc., A.M.I.E.E.,
King's Bldgs., Dean Stanley St., London, S.W.1.
Phone: VICTORIA 5035.

★ **COUPON** value **2/6**

N. PARTRIDGE, B.Sc., A.M.I.E.E.,
King's Buildings, Dean Stanley Street, London, S.W.1

Please send me free of charge a copy of the **PARTRIDGE P.A. MANUAL** in accordance with your offer.

NAME.....
ADDRESS.....

W.W. 24/8/39

REPAIRS AND SERVICE

MAINS Transformer Service. Repairs, rewinds, or construction to specification of any type, competitive prices and prompt service.—Sturdy Electric Co., Dip-ton, Newcastle-on-Tyne [0516]

METROPOLITAN RADIO SERVICE.—Guaranteed repairs to American and British receivers; American valves, service parts and rewinds, trade supplied.—1021, Finchley Rd., N.W.1. Speedwell 3009. [0435]

REPAIRS to Moving Coil Speakers a Speciality; cones and coils fitted, fields altered; prices, including eliminators quoted; loud speakers, 4/-. L.F. and output transformers, 4/-. post free, guaranteed satisfaction, trade invited, estimates free; prompt service.—Loud-Speaker Repair Works, 5, Balham Grove, London, Battersea 1321. [0394]

SITUATIONS VACANT

AIR MINISTRY.

DIRECTORATE of Signals (Civil Aviation).

APPLICATIONS are invited for Appointments as Civilian Wireless Operators at Air Ministry Civil Aviation Wireless Stations.

APPLICANTS, who should not be above 40 years of age on 1st September, 1939, should preferably possess the 1st Class Postmaster-General's Certificate or the Air Operator's Certificate in Wireless Telegraphy and have had experience of radiotelephony, direction-finding and maintenance work. Operators will be required to serve at any Air Ministry Civil Aviation station at home or abroad. At present there is only one station situated outside the United Kingdom manned temporarily by Air Ministry staff.

SALARY is at the rate of 67/- a week, rising by annual increments for approved service to 112s. a week inclusive. Should candidate be required to serve abroad appropriate additional allowances would be paid.

THE First Two Years of Service will constitute a Probationary Period, and confirmation of appointment will be contingent on an operator passing an examination in all phases of his work.

POSTS will be Unestablished, i.e., non-pensionable in the first instance. A portion of the total staff is pensionable, however, and subject to the existence of vacancies in the permanent staff operators may be considered for establishment according to their seniority, conduct and ability, provided that the probationary period has been satisfactorily completed.

REQUESTS by Postcard for Forms of Application should be addressed so as to reach the Under-Secretary of State, Air Ministry (S.1.), Kingsway, London, W.C.2, not later than the 25th August, 1939.

SELECTED Applicants will be Required to Attend at the Air Ministry for Interview on the 7th and 8th September, 1939.

NO Application will be Considered Unless the Applicant States that he will be Able to Attend on Either of These Dates.

NO Other Arrangements Regarding Interview can be Entertained. [8829]

YOUNG Men with Experience of Wireless Operating.

REQUIRED for Three Years' Service as Constables in the Palestine Police Force. Pay £11 a month (plus trade pay of £3 per month when employed as wireless operators), uniform, rations and quarters; free passages and leave on full pay; candidates, age 21-28, must be single, of good physique and physically fit, and must hold a Postmaster-General's certificate in wireless telegraphy.—Apply, stating exact age, height and particulars of education and training, to the Crown Agents for the Colonies, 4, Millbank, London, S.W.1. Head your letter "Palestine Police." [8830]

WIRELESS.—Telecommunication assistants required for radio work at Army Stations in Great Britain.

SALARY £250, rising by annual increments of £10 to £300 a year.

CANDIDATES should preferably be under 45 and must possess sound practical and theoretical knowledge of commercial short-wave transmitters and receivers, and should preferably hold Final (Grade III) Certificate of City and Guilds of London Institute Examination in Radio Communication or equivalent qualification. A thorough knowledge of testing and servicing and the repair of short-wave transmitters and receivers is essential.

SUITABLE Candidates may be set a short theoretical and practical test. Those selected will undergo a course of instruction and will be required to enlist in the Territorial Army (with rank of Staff Sergeant).

APPOINTMENTS are Not Pensionable. Preference given to ex-Service candidates, other things being equal.

APPLICATIONS Obtainable by Postcard from the Under-Secretary of State (C.5), War Office, and to be lodged by September 2nd, 1939. Quote Appts. No. 161. [8825]

RADIO Service Engineer, permanent job right man.—Hamnants, 28, Bell St., Henley-on-Thames. Phone: 220. [8832]

RADIO Firm Require Foreman, able to lay out for efficient production and capable of testing completed receivers; also wireman; only men used to high class work need apply.—Box 815, c/o The Wireless World. [8821]

THE ATTRACTION AT THE MOMENT—
OLYMPIA RADIO EXHIBITION!

THE ATTRACTION FOR ALL TIME—

HIGH-GRADE AMPLIFIERS,
TRANSFORMERS, CHOKES OF
ALL TYPES, SUPER-QUALITY
LOUD-SPEAKERS, and LAST
BUT BY NO MEANS LEAST

"TRI-CHANNEL AMPLIFICATION"

by
SOUND SALES LIMITED.

N.B.—You simply must visit Olympia during the Show, and you simply MUST visit SOUND SALES Show-rooms at Holloway if you are really interested in any of the above items. Alternatively, may we have the pleasure of sending YOU a copy of our latest catalogue and technical manual—

PRICE 6D.

Specified by the Experts



MARLBOROUGH RD., UPPER HOLLOWAY, LONDON, N.19. (Contractors to H.G.P.O., etc.)
LIMITED. Tel.: Archway 1661/2/3
Hours of Business—Monday to Friday, 8.30 a.m. to 6 p.m.

SATURDAYS CLOSED

RADIOMART
G.S.N.I. (BIRMINGHAM) LTD.

THE SHORT-WAVE SPECIALISTS

SPECIAL OFFER!!!
Fully shrouded Transformers by America's largest manufacturer. While they last,
All 230 v. primary and fully impregnated.
T28708—375/375 v. 150 m/A., 6.5V6A. 2.5V6A. 5V3A. 15/-
T19610—350/350 v. 150 m/A., 2.5V6A. 2.5V6A. 5V3A. 12/3
T7298—375/375 v. 120 m/A., 6.3VCT. 3A. 5V3A. 10/6
T7326—350/350 v. 100 m/A., 6.3VCT. 3A. 5V3A. 8/6
T7307—350/350 v. 80 m/A., 6.3VCT. 3A. 5V3A. 7/5
T7000—320/320 v. 80 m/A., 6.3V4A. 5V3A. 7/6
T6025—320/320 v. 80 m/A., 2.5V6A. 5V3A. 7/6
T44410—10V4A Primary Tapped 110—250 v. 5/3
T11124B—110/230 v. 500 watt Auto Transformer. 29/6
The following chokes are interrelated and impregnated.
T7007—250 m/A., 135 ohms, 20-8 Hy., cadmium shrouded. 12/6
T7007A—150 m/A., 250 ohms, 20-12 Hy., cadmium shrouded. 12/6
100 m/A., 20 Hy., 500 ohms, unshrouded. 4/11
100 m/A., 15 Hy., 250 ohms. 1/11
4 m/A., 1,500 v. test 500 v. v.k.g. oil filled condensers, 2/-.
HEAVY DUTY MAINS Transformer, worth 45/-. 350-350. 150 m/A. 4 v. 2.5 a. CT. 4 v. 6 a. CT. 12/3; 300-300 v., 80 m/A., 4 v. 3 a. CT. 4 v. 2 a. CT. 6/6. Moving Coil Speaker Transformers power, pentode or push pull LIT. WB Heavy duty ditto 2/11.
GANG CONDENSERS with Airplane Dial, 3 and 80-1. Cost 35/-. Few only. 4/11. Utility, 7/6. Microdials, 3/0.
W.B. 81a. PERMANENT MAGNET SPEAKERS AT ONE-THIRD COST! Extension Type (no Transformer), 8/11. Standard Type (with Transformer), 10/6. Energised 8", 1,200 ohms with Transformer, 5/11.
PUSHBACK Wire 7 yds., 6/-. heavy 9/-. Resin-coated Solder, 6/6. Tags, 6/1 packet. Humdimmers 6d. each. Control pots, all sizes, 1/6; switched, 2/-. tubular fuses, 2d. Milliammeter, 25 m.a., upwards 5/9.
VALVES: Reliable replacements for all types, British and American, showing saving of over 50 per cent.
OUT. NEW 66-PAGE MANUAL packed full of valuable information. Communication receivers, transmitters, etc. 7d. post free.
THE NEW RAYMART CATALOGUE shows dozens of New Short-wave Components and is yours for 1d. post free. **TRADE ENQUIRIES** solicited or all types of communication equipment, transmitters, r. receivers, etc.

RADIOMART Telephone: MIDland 3254
G.S.N.I. (Birmingham) Ltd.
44, HOLLOWAY HEAD, BIRMINGHAM

THE INSTITUTE OF WIRELESS TECHNOLOGY
(Founded in 1925. Incorporated.)
EXAMINATION ENTRIES
Candidates for the November Examinations must apply not later than September 30th.
Application Forms and Syllabus may be obtained from the Secretary:—Harrie J. King, F.C.G.S., Institute of Wireless Technology, 4, Vernon Place, Southampton Row, London, W.C.1.
Phone: Holborn 4979.

SITUATIONS VACANT

EXPERIENCED Television Servicemen Required for Indoor and Outdoor Work; only written applications considered; state age, education, previous trade experience and if owner driver.—G.E.C. Service Depot, Greycoat St., Westminster, S.W.1. [8840]

BOYS, 16-18 years, of good education, to assist with inspection of communication equipment; knowledge of A.C. engineering desirable but not essential; S.E. London district.—Write Box 5864, A.K. Advg. 4, Talbot Mansions, Museum St., W.C.1. [8828]

RADIO Testers Required; applicants must have had technical training and experience of receiver circuit trimming on factory production lines.—Apply Employment Dept., Murphy Radio, Ltd., Welwyn Garden City, Herts, or nearest Employment Exchange. [8826]

RADIO Service and Installation Engineers Required. Limited vacancies, staff appointments, training and advancement to television when ability and personality is proved.—Write, stating age, experience and salary required, to Box 817, c/o The Wireless World. [8823]

DESIGNER Engineer Required for Leading Radio Manufacturers in North-West London, experience in design, research and development of all-wave radio receivers essential; progressive position for man with initiative.—Write, stating age, experience and salary required, to Box 853, c/o The Wireless World. [8831]

ENGINEERS Required for Calibration Work on Electronic Instruments; applicants should have had experience on similar work and should have sound knowledge of electrical and radio theory; application should be made in writing, stating previous experience, training and salary required.—Marconi-Ekco Instruments, Ltd., Southend-on-Sea. [8827]

TECHNICAL Radio Representative, experienced, to contact manufacturers and services, required by manufacturers of specialised components under new patents; state experience and salary required; this appointment offers unusual opportunities.—Box 751, c/o The Wireless World. [8795]

RADIO Communication Test Section of Large Firm Require Engineers with experience in handling laboratory type measuring apparatus, knowledge of ultra high frequency transmission equipment an advantage, but fundamental knowledge and adaptability would find scope in new field of development.—Write, stating qualifications, experience, age and salary expected, Box 818, c/o The Wireless World. [8822]

SITUATIONS WANTED

RADIO Development Engineer, University degree, long experience, foreigner, skilled in Army transmitters, anxious to find employment in United Kingdom; stay in London during Olympia Show.—Write Box 816, c/o The Wireless World. [8820]

RADIO Engineer, Chinese, 3 years' research work in Germany, Dipl. Ing., will take Dr. Ing. in few months, speaks English and German, experience with design of short-wave radio apparatus, valves; several inventions; seeks research work.—Wang, c/o Elektro-Physikalisches Laboratorium dmt T.H., Munich, Germany. [8819]

ELECTRIC DRY SHAVERS

REMINGTON, Rand, Shavemaster, Packard, Casco, Rabaldo.—Trade enquiries to Leonard Heys, 36, Henry St., Blackpool. [0633]

MISCELLANEOUS

CHEAP Printing—1,000 billheads, 3/6; sample free.—Creteway Press, 18, Buxted, Sussex. [8180]

EVERY Radio Dealer Who is Not a Regular Reader of "The Wireless and Electrical Trader" should send his trade card at once for a specimen copy and full details of the "Trader" Services. "The Wireless and Electrical Trader" has the widest influence, the largest weekly circulation, and is read by all the leading manufacturers and traders. Trade only. 15/- per annum, post free.—Published at Dorset House, Stamford St., London, S.E.1. [0615]

"ENGINEER'S Guide to Success" Shows How to Qualify in Television Radio Engineering and Servicing, sound, recording, wireless communicating, etc., by studying at home with the T.I.G.B. Write to-day for this Great Guide—free—which gives full particulars, contains the world's widest choice of engineering courses—over 200—and alone gives the regulations for qualifications such as A.M.I.E.E., A.M.I.R.E., A.M.I.T.E., A.M.I.W.T., C. and G., etc. Training until successful guaranteed.—The Technological Institute of Great Britain, 82, Temple Bar House, London, E.C.4. (Founded 1917. 20,000 successes.) [8782]

PATENTS

"PRACTICAL Hints on Patents," free on application. The Imperial Patent Service, First Avenue House, High Holborn, W.C.1. Preliminary consultation free. [0431]

TUITION

RADIO Training—P.M.G. exams and I.E.E. Diploma; prospectus free.—Technical College, Hull. [0611]

PRACTICAL Postal Courses, radio television; test equipment design; I.P.R.E. and I.W.T. exams.—Write I.P.E., 3, Shirley Rd., London, W.4. [8838]

WIRELESS.—Complete training Marine, broadcast and television; posts waiting; mod. fees; boarders taken; approved college, prosp.—Dept. W., London Radio College, Grove Park Rd., London, W.4. (Chi. 3244.) [0580]

STAND 101

FOR THE VERY LATEST
BRITISH MADE
INSTRUMENTS

VALVE TESTERS—SIGNAL GENERATORS—
OSCILLOSCOPES—UNIVERSAL METERS—
SINGLE RANGE METERS including the

**NEW 17 RANGE D.C. and
32 RANGE UNIVERSAL**

TAYLOR METER

EVERY INSTRUMENT
HAND CALIBRATED

MODEL 90

Incorporating a 4 1/2" moving coil jewelled movement meter with a sensitivity of 1,000 ohms per volt A.C. and D.C., this instrument covers D.C. volts. 0.25-1,000 in 7 ranges A.C., and Output volts. 2.5-1,000 in 6 ranges each: D.C. Amps. 1 mA-2.5 amps. in 5 ranges: A.C. amps. 1 mA-2.5 amps. in 4 ranges: 1-10 megs. 7 G S.

MODEL 95

Is similar in appearance and sensitivity to Model 90 but is for D.C. and Resistance only. It covers 0.1-1,000 volts. in 7 ranges, 1 mA-2.5 amps. in 4 ranges, 1-10 megs. in 4 ranges.

BRITISH MADE.
FULLY GUARANTEED.
Waterproof Cover, 7/6.
Full details and specifications will be sent on request.

£5.15.0
LOW DEPOSIT.
EASY TERMS
AVAILABLE.

TAYLOR ELECTRICAL INSTRUMENTS LTD.,
45, Foubert's Place, Regent St., LONDON, W.1

BUSINESSES AND PROPERTY FOR SALE, TO BE LET, OR WANTED

"THE Wireless and Electrical Trader" is an essential part of the equipment of every Wireless Trader; its pages reflect the very latest turn of trade events, and it is read by all the leading dealers and manufacturers, for particulars of businesses offered or wanted. By subscription to the trade only, 15/- per annum, post free.—Send your trade card for specimen copy to Dorset House, Stamford St., London, S.E.1. 10614

BOOKS, INSTRUCTION, ETC.

A MERICAN Valve Data.—The 200-page Raytheon Data Book gives full characteristics, applications, all types American valves; invaluable to servicemen; post free anywhere; 2/3.—Leonard Heys, 36, Henry St., Blackpool. [0594]

"WIRELESS World" Bound Volumes 28 to 30, new bound volumes 31 to 37; also Television, October, 1932, to December, 1935; offers, separately, or the lot.—Smith, 9, Mellor Rd., Prenton, Birkenhead. [8820]

A LL Wireless and Radio Engineering Books Available through new financial terms as low as 2/6 monthly.—Write a card or call personally for details and lists from the Radio Department, Phoenix Showrooms, 66, Chandos Place, Strand. [8623]

"ELEMENTARY Principles of Wireless Telegraphy and Telephony." By R. D. Bagnay. Revised by O. F. Brown, B.Sc. Third edition (1930). The standard textbook for wireless students and beginners. Deals with the whole subject of wireless telegraphy and telephony, avoiding too technical a treatment of the problems involved. Well illustrated. Price 7/6 net. By post 8/-. from Iliffe and Sons Ltd., Dorset House, Stamford St., London, S.E.1.

"THE Wireless World" Diary for 1939 contains 77 pages of facts, formulae and general information of the kind that is always wanted but is difficult to follow. Also a list of the most important European Broadcasting Stations and short-wave stations of the world. Twelve pages of circuit diagrams of receivers, amplifiers and units.—By post 1/7 from Iliffe and Sons Ltd., Dorset House Stamford Street, London, S.E.1.

"FOUNDATIONS of Wireless." By A. L. M. Sowerby, M.Sc. Second edition. An elementary textbook on receivers. Deals fully with the construction of wireless sets, valves, and the process of detection. Price 4/6 net. By post 4/11, from Iliffe and Sons Ltd., Dorset House, Stamford Street, London, S.E.1.

"RADIO Data Charts." By R. T. Beatty, M.A., B.E., D.Sc. Second edition. A series of Abacs providing most of the essential data required in receiver design and enabling problems to be solved without having recourse to complicated mathematical formulae. Price 4/6 net. By post 4/10, from Iliffe and Sons Ltd., Dorset House, Stamford Street, London, S.E.1.

RADIO LABORATORY HANDBOOK

By M. G. SCROGGIE, B.Sc., A.M.I.E.E.

Issued in conjunction with "The Wireless World"

"Radio Laboratory Handbook" gives the serious wireless worker complete information from first-hand experience about laboratory equipment, the instruments which are necessary and the correct methods of operating them.

The fundamental principles are fully discussed, as well as the sources of power and signals, instruments and measurements. Ultra-high-frequency work, the working out of results, and reference data are also dealt with. There is a collection of the most useful symbols, abbreviations, formulae, laws, curves, tables and other data.

A complete index, numbered sections and cross references enable the reader to find what is required without loss of time.

384 pp. 211 illustrations

PRICE 8/6 NET By Post 9/-

From Bookstalls and Booksellers or direct from the Publishers

ILIFFE & SONS LTD.,
DORSET HOUSE, STAMFORD ST., LONDON, S.E.1

ELECTRADIX

METERS, GALVOS, BRIDGES, MEGGERS, RECORDERS, LAB. EQUIPMENT, CHARGERS, SWITCHGEAR, RES. AND INSTRUMENT WIRE, RELAYS, MOTORS AND DYNAMOS, AMPLIFIERS AND MICROPHONES.

LARGE SELECTION ALWAYS IN STOCK.

DIX-MIPANTA VEST POCKET TESTER. A wonderfully versatile moving-iron multi-range meter for service on A.C. or D.C. jobs. No projecting terminals. THREE ranges of volts: 0-7.5, 0-150, 0-3000 Preset for MILLIAMMERS, reads: 120 m.a. and 75 m.a. In black bakelite case. Measures only 2 in. by 2 1/2 in., with pair of test leads and plugs. Lead "N" gives full information. 19/6.

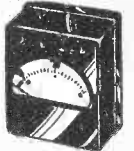

THE FAMOUS DIX-ONEMETER is advertised on page 16 of this issue.

ELECTROSTATIC VOLTMETERS.—2 1/2 in. panel, 2,500 volts, 5 in. switchboard, 6,000 volts, at 12,000 volts and 60,000 volts **MILLIAMMETERS.** 8 m.a. back of panel illuminated milliammeters. Skeleton type, 970 ohms D.C. with plain scale and 1 in. needle with mica panel, back lamp and bracket. Great bargain at 3/9 post free. Bulgain Midgets, 8 m.a., 6/-; Sifam, 1 1/2 in., 10 m.a., 8/6. 2,000 meters to select from.

CHARGE METERS. Weston Model 354. Central zero 1 to 15 amps., pol. mag. dead beat. Flush panel, 2 1/2 in. dial. Sale price, 5/-. Weston 0 to 36 m.a. mov. coil milliammeters, 17/6; 0-5 m.a., 17/6. Hoyt CZ mov. coil milliammeters, 20-0-25 m.a., 10/-. **H.F. AERIAL RADIATION METERS.** Flat panel, 2 1/2 in. dial, Hot wire, 0-500 m.a. 7/6; 0 to 2 amps, 12/6; 0 to 24 amps, 12/6. 3 in. dial ditto, 0-4 amps, 21/-; Panel 4 in. dial, 3 amps., 11/10/-; 7 in. dial, 2 to 15 amps., 35/-.

MICRO-AMMETERS for small current Valve Voltmeters, etc. Sensitivity, 0 to 50 microamps full scale. 1 micro A. per div. New, 1,000 ohms coil. Cheap at 40/-. Fitted platinum contacts for CZ Relay, 50 microamps coil, 100 m.a. contacts, 55/- only, for the most sensitive Panel Relay made.

VIBRATOR BATTERY SUPERSEDER with metal rectifier, for H.T. from your 2-volt battery. 3 output volt. tapplings. Reduced from 23/15/- to sale price, 35/-.



CRYSTAL SETS, plug-in coils, 2 tuning condensers, semi-perm. Detector, 5/6. One for your A.R.P. shelter. Cheap.

BUZZERS, MODEL D. BUZZERS for Morse signals 1/-; Buzzers to replace Bells, 1/-; Buzzers for circuit testing, 1/-; All British make, 1/-; Bell Bobsins, small twin, 2-pole, 8d.

MORSE PRACTICE SETS, No. 3, with key buzzer and lamp for sound and visual, line plug, etc., 7/-; Sound Type, 1A type key and buzzer, 3/-; Visual Type 2A, key and lamp, 2/-.

ALARM BELLS, Small and large. Battery or mains D.C. or A.C. 10in. gong. Domestic Bells and Fire Bells, cheap. Please state wants. Single Bell Wire, 1/- per 100 yds.

METER MOVEMENTS. Full size, moving coil, P.M., for adapting home-made multi-range testers. For 3in. or 4in. dials, 5/-; post 1/-. **LIGHT AND RAY CELLS.** Selenium 7/6; Electrocell, 25/-; Rayonite, 15/-; Small and large. Battery or mains D.C. or A.C. 10in. gong. Domestic Bells and Fire Bells, cheap. Please state wants. Single Bell Wire, 1/- per 100 yds.

RELAYS. Single and multiple contact telephone type in 15 models from 5/-. Send for Relay List, Genuine G.P.O. Vertical Relays, brass case, glass top, with original platinum contacts. Worth the money. 5/- to clear. Mov. Coil Weston, 60/-.

15-DAY TIME SWITCHES. Verner 1 amp., 5 amps., 100 amps., 200 amps. From 17/6.

THERMOMETERS. Panel 2 1/2 in. dial, 5 in. ether tube, for distant indicating, reading 0 to 100 deg. Cent. 7/6. Cambridge, 10/6. **FOUNTAIN THERMOMETERS** by Cambridge Instrument Co. 4 in. dial, 10-110 deg. Cent. Fitted adjustable electric contacts, 45/-.

FUSES. Glass tube, 1 amp., 6d. With clips and base, 9d. **HEADPHONES.** Lightweight. Famous makes, 2,000 ohms, 4/6. Single high res. earpieces, 2/6. Sullivan 120 ohm. W.D. model. Aluminium body and headbands. Maker's price 10/-, 15/-. Our price 2/9 per pair, 3d. postage.

MORSE INKER Tape Strip Recorders; portable or table. Cheap. Wheatstone Strip Hand Perforators 15/-. Paper Tape for Morse and Wheatstones, green or white, 6d. reel. Brass Tape Reels in mahogany case, 2/6.

KEEP YOUR BATTERY READY. **BATTERY CHARGING ON A.C. MAINS WITH THE A.C. NITDAY** will keep your battery fit without attention. Model N/A6, 100/250 volt A.C. and D.C. 6/8 volts 1 amp., 15/-; Model N/B6, 100/250 volts to D.C. 6/8 volts 1 amp., 25/-; Model N/C6, 100/250 volts to D.C., 6/8 volts 2 amps., 35/-; Model N/D12, 100/250 volts to 12 volts 1 amp., 32/-; Ditto, 12 volts 2 amps., with 6-volt tap, 55/-; 5 amp., 54/10/-.

MOTORS, MOTORS, MOTORS. Tiny, Small and Medium. A large stock of really fractional horse-power motors have been released at bargain prices. 6 volts, 50 volts, 100 volts and 230 volts.

A.C. MAINS MOTORS. Enclosed, self-start on load. A.C. repulsion, 1/60 h.p. with pulley, Type 36, 1,500 revs., 18/6; Ditto, 1 1/2 h.p. G.E.C., 3,500 revs., 27/6; Induction 110 h.p., 2,500 revs., 35/-; 4 h.p., 1,425 revs., 49/-.

D.C. MAINS MOTORS. 1/40 h.p., 110 v. or 220 v., K.B. series, 1,750 revs., 15/-; Ditto, 1/40 h.p., G.E.C., 230 v. series, 2,000 revs., 16/-; Ditto, 1/12 h.p., Crolyon 110 and 230 v. shunt, 1,700 revs., 30/-.

ALUMINIUM PANELS for Transmitters and Testers, substage or front. Heavy gauge flat and true, enamelled one side, black or brown, 18 gauge, 12in. x 12in., 3/-; 16 gauge, 3/10; 18 gauge, 12in. x 18in., 4/6; 16 gauge, 5/9; 18 gauge, 18in. x 18in., 5/6; 16 gauge, 6/4. Black Paxofin and Ebonite Panels, all sizes from 2 1/2 in. x 2 1/2 in. Tubing formers, 3d.

WIRE WOUND POWER RESISTANCES. 5 watt 8,000 ohms, 13 m.a., 10d. 5 watt Potential Dividers, tapped 50,000 ohms, 1/6. Mains Transformers 2/6. 1-mfd. Condensers, 4d.

CONDENSERS. Variable low-loss F type, .0005, 1/9. J.B. 0003, 2/-; Reaction varia., 1/3. Pye, .0003 with S.M. dial, 5/-; 2-gang varia., all aluminium, 3/- only. Fixed Condensers, 2 mfd. 250 v., 6 for 4/-, 3/- doz. 4,000 v. 1/2 mfd., 6/-, etc.

SPECIAL CLEARANCE. Parcels of experimental oddments, coils, magnets, wire chokes, condensers, mikes, switches, terminals, etc. Post free, 10lb., 5/-; Very useful bargain.

Come to us for Dynamos, Motors, Meters, Mikes, Testers, Recording Gear Lab. Instruments, Projectors and Soundheads.

Over 1,000 other Bargains in our Big Illustrated List "W."

ELECTRADIX RADIOS,

218, Upper Thames Street, London, E.C.4.

Telephone: Central 4611

ENGINEERS! ARE YOU EARNING LESS THAN £10 PER WEEK?

If so, you cannot afford to carry on without reading our 268-page Handbook. The book explains clearly and definitely many ways of carving out a successful career. Among other things it explains the Services of our unique Appointments Department; outlines Home-Study Courses in all branches of Civil, Mechanical, Electrical, Motor, Aero, Wireless, "Talkie" Engineering, Building, Govt. Employment, etc., and gives details of B.Sc., A.M.I.C.E., A.M.I.E.E., A.M.I.Mech.E., A.M.I.A.E., A.M.I.W.T., A.M.I.R.E., G.P.O., MATRIC., and all Exams. We Guarantee — "NO PASS—NO FEE." Whether you be an old hand or a budding apprentice get this book to-day. FREE and POST FREE.

BRITISH INSTITUTE OF ENGINEERING TECHNOLOGY,
387, Shakespeare House, 17/19, Stratford Place, London, W.1.

Do do quite a lot of business making up transformers to customers!
own specifications: but we have a standard list. May we send you a copy?

W. BRYAN
WESTMORELAND RD., LONDON N.W.9

SAVAGE LTD
PHONE, COLINDALE 7131

"1940 RADIO INSIDE OUT."
NOW AVAILABLE.—A Revised Edition of this most popular Radio Manual. Up-to-date Chapters on Modern Receivers. Tabulated list of exact Service Replacements: Valves, Condensers, Volume and Tone Controls, etc. A host of practical hints for the Technician. Colour Codes, Charts, Technical Formulae, New Valve base connections, etc. One Book in Three Sections. Available in three parts. STAND No. 12, RADIOLYMPIA, W. H. Smith and all Booksellers.

Published by **NORMAN ROSE (Electrical) LTD.,** WAVEBAND HOUSE, 43, Lamb's Conduit St., London, W.C.1.

Cage Birds
and Bird Fancy

The weekly journal for all who keep Canaries, British Hybrids or Foreign Pet Birds.

EVERY FRIDAY 3d.

W.W.98
Specimen copy of recent issue free on request from The Publisher, Dorset House, Stamford Street, London, S.E.1

FOURTH EDITION

Revised and Enlarged with 50 Additional Pages

WIRELESS SERVICING MANUAL

By **W. T. COCKING**

(of "The Wireless World")

The most complete book of reference of its kind. A reliable practical guide for amateur and professional

The present Edition of the "Wireless Servicing Manual" brings the material of the book right up to date and includes an additional chapter on television receivers which is practically the only source of servicing information available on this subject.

Testing apparatus is fully dealt with and the methods of locating and curing faults in receiving equipment are explained.

Ganging, Automatic Volume Control, Instability, Distortion, Mains Hum, Whistles, Local Interference and Aerials, are all separately treated.

The reference material, including base-connections for British, Continental and American Valves, and the various colour codes for components, has been extended and revised.

BOUND IN CLOTH BOARDS

SIZE 7½ ins. × 5 ins.

288 Pages

5/- net. By post 5/5

In conjunction with "THE WIRELESS WORLD" and Published by the Proprietors:—
ILIFFE & SONS LTD., DORSET HOUSE, STAMFORD STREET, LONDON, S.E.1

INDEX TO ADVERTISEMENTS

A.C.S. Radio	PAGE	Erie Resistor, Ltd.	PAGE	Pifco, Ltd.	PAGE
All Power Transformers, Ltd.	20	Exide Batteries	11	Players Cigarettes	4
Ambassador Radio Works	16	Fluxite, Ltd.	15	Postlethwaite Bros.	Inside Back Cover
Armstrong Manufacturing Co.	14	Garrard Eng. & Mfg. Co., Ltd.	2	Premier Radio Stores	8
Automatic Coil Winder Co., Ltd.	1	General Electric Co., Ltd.	9	Radio Manufacturers' Association	7
Belling & Lee, Ltd.	6	H.M.V.	Back Cover	R.G.D.	3
Birmingham Radiomart G5N1	18	Institute of Wireless Technology	18	Rose, Norman	19
Birmingham Sound Reproducers, Ltd.	2	London Radio Supply Co.	15	Savage, W. Bryan, Ltd.	19
British Institute of Engineering Technology	19	Lockwood & Co.	15	Scophony, Ltd.	10
British Insulated Cables, Ltd.	Inside Back Cover	McClure, John, Ltd.	20	Sound Sales, Ltd.	18
British McMurdo Silver Co., Ltd., The	4	M.R. Supplies	16	Steatite & Porcelain Products, Ltd.	8
British Pix	12	New Times Sales Co.	17	Stratton & Co., Ltd.	12
Bulgin, A. F. & Co., Ltd.	13	Northern Polytechnic	17	Taylor Electrical Instruments	19
Cossor, A.C., Ltd.	5	Pamphonic Reproducers, Ltd.	16	Varley, Ltd.	2
Degalliers	Inside Front Cover	Partridge, N.	17	Voigt Patents, Ltd.	17
Dubilier Condenser Co., Ltd.	Inside Front Cover	Peto-Scott, Ltd.	11	Vortexion, Ltd.	15
Electradix Radios	16, 19			Westinghouse Brake & Signal Co.	Inside Front Cover
				Whiteley Electrical Radio Co., Ltd.	13

McCLURE HANDBUILT RADIO

Every McClure product incorporates the latest refinements, is designed with unlimited care to perform its work faithfully and to give efficient and lengthy service.

TUNING UNITS Types ACT5 & UT5

5-waveband Tuning Units of quality, covering the following ranges: 12-35 m.; 30-80 m.; 75-200 m.; 200-550 m.; 660-2,000 m. Tuned RF stage on all bands; triode hexode frequency changer. Full vision scale with spreader drive. Hand built and calibrated. For use with I.F.s of 465 Kcs. Complete with 4 v. AC valves or 6.3 v., 2 amp. E type valves.

PRICE £5.10.0

- 3 BANDS from 16 to 2,000 m. £4.10
- 4 BANDS from 12 to 2,000 m. £5.0
- 5 BANDS without gaps from 44 to 2,000 m. £8.0

Full details on request.

Write — Edward Thomas,
Facilities Dept.,
JOHN McCLURE LTD.
(G6JM)
ER&KINE RD., LONDON, N.W.3
PR1mrose 5435-6

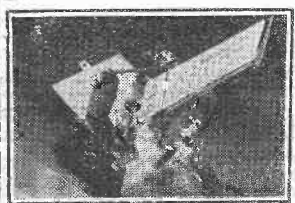

3-Band Tuning Unit

ALL-POWER

MAINS EQUIPMENT SPECIALISTS

We are equipped and qualified to handle quantity orders for Chokes and Transformers
High Voltage TELEVISION Transformers,
also Power, Output, Intervolve and Line,
are in regular production.

MANUFACTURERS ENQUIRIES ARE INVITED.

For Efficiency, Reliability and Speedy Delivery get in touch with **ALL-POWER.**

ALL-POWER TRANSFORMERS LTD.

8a, Gladstone Road, Wimbledon, S.W.19. LIBerty 3303.

B.I. RADIO MATERIALS

We have had a long experience in the manufacture of all kinds of Cables and Wires, Aluminium Sheets and Strips, Static Condensers, Insulators and Iron Work, Telephone Cords and Copper Earthing Rods, for Radio use.

VISIT OUR STAND AT THE NATIONAL RADIO EXHIBITION STAND No. 20



BRITISH INSULATED CABLES LTD.,
CABLE MAKERS AND ELECTRICAL ENGINEERS,
PRESCOT, LANCS. Tel. No. PRESCOT 6571

Memo
Don't forget
Player's
Please

PLAYER'S MEDIUM NAVY CUT CIGARETTES

MEDIUM or MILD
10 for 6²/₂ 20 for 10²/₂

PLAYER'S NAVY CUT CIGARETTES

NCC495B

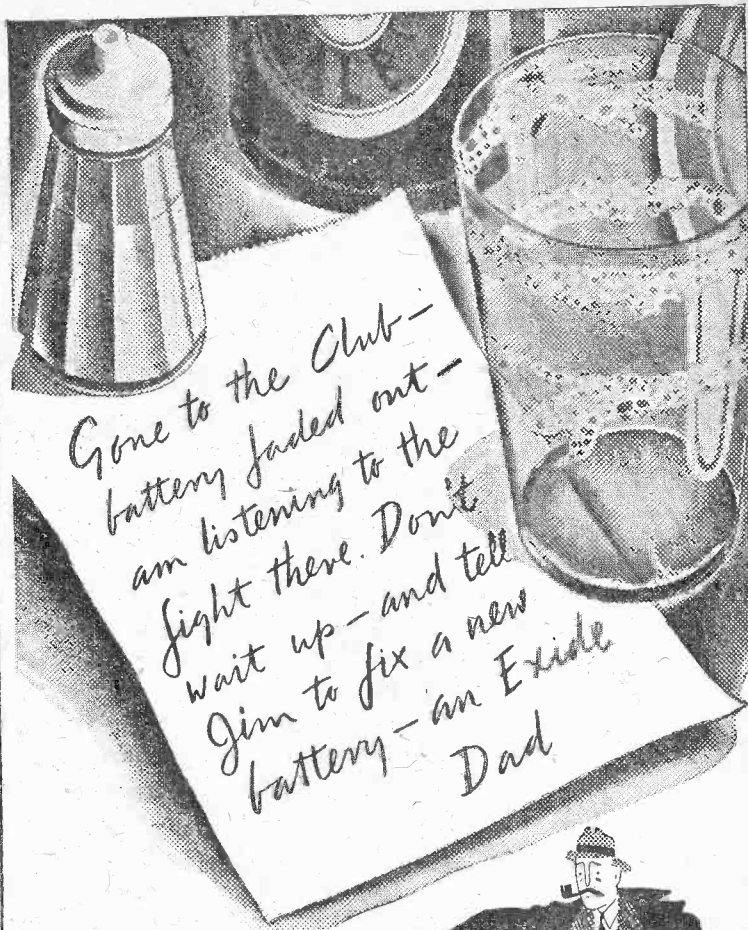

All batteries must die. But it's a long long time before Exide and Drydex do. And they never fade out unexpectedly, leaving you with a silent radio. The Exide Accumulator has a Charge Indicator which warns you when it's time to recharge. As for the Drydex H.I., it almost seems that it never will run down. And when it does, it peters out very gradually, without sudden failure.

Visit Exide at
STAND NO. 2
Radiolympia
AUG. 23 to SEPT. 2

NEXT TIME GET

Exide AND Drydex

RADIO ACCUMULATORS & DRY BATTERIES

'Still keep going when the rest have stopped'

THE CHLORIDE ELECTRICAL STORAGE CO. LTD. (Exide and Drydex Batteries), EXIDE WORKS, CLIFTON JUNCTION, NR. MANCHESTER. Also at London, Manchester, Birmingham, Bristol, Glasgow, and Belfast.

Mention of "The Wireless World," when writing to advertisers, will ensure prompt attention.



THREE WORDS...

That mean so much to you!

In the whole vast field of home entertainment, three words have always been outstanding . . . "His Master's Voice."

To-day that name leads in a new field of achievement—Television, and here "His Master's Voice" engineers are in a unique position.

They are not only fully conversant with the developments in transmission technique, but over the past three years have amassed an unrivalled fund of detailed information, on the score of what best will reproduce the programmes sent out from Alexandra Palace under reception conditions of the widest possible variety.

This intensive field research manifests itself in the 1940 "H.M.V." receivers in many exclusive features.

Take an early opportunity of examining them at your "His Master's Voice" dealer's. He is specially qualified to advise you.

HIS MASTERS VOICE

Television

'CLEARLY' THE BEST!

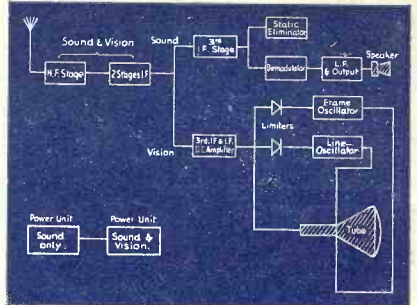

Block circuit diagram of the arrangement of the new "His Master's Voice" Television receivers. The high efficiency H.F. stage gives very high sensitivity and the arrangement of the line and frame oscillators ensures constant locking of the synchronising circuits.

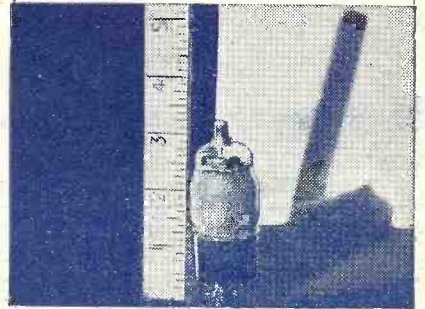

The new Z62 H.F. valve as employed in the H.F. stages of the new "His Master's Voice" Television receivers owes its high efficiency in a large measure to the compactness of its design and the very stable electrode arrangement.

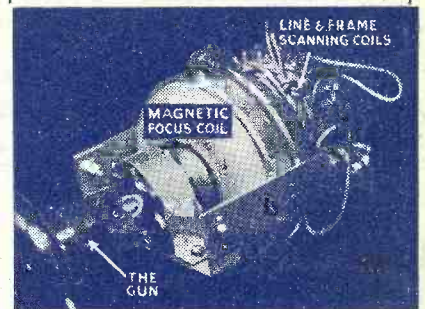

On the neck of the cathode ray tube in the new "His Master's Voice" Television receivers is supported this unit, which ensures the accuracy of focus and also provides the magnetic fields for line and frame scanning.

OTHER FEATURES INCLUDE

- ★ Phase reversal sound interference suppression.
- ★ Triode Cathode ray tube.
- ★ Accurate transient amplification and wide band I.F. circuits.

★ COUPON

To "His Master's Voice," 98-108, Clerkenwell Road, London, E.C.1
 I should be glad to receive a copy of your booklet illustrating the complete new range of "His Master's Voice" Television Receivers.

NAME.....

ADDRESS.....

W. W. 24/8

5/28/39/39

SHOW REVIEW

The

Wireless World

6^D

THE PRACTICAL

RADIO & TELEVISION JOURNAL

Thursday, August 31st, 1939.



GEALLOY
RADIO
CORES

Our booklet S.37 gives details of the types available and will be sent on request.

SALFORD ELECTRICAL INSTRUMENTS LTD.

PEEL WORKS, SALFORD 3

Telephones: BLACKFRIARS 8888 (3 lines)

Telegrams and Cables: "SPARKLESS, MANCHESTER"

PROPRIETORS: THE GENERAL ELECTRIC Co. Ltd., OF ENGLAND

Mention of "The Wireless World," when writing to advertisers, will ensure prompt attention.

PRECISION METERS

that Master every Testing Problem

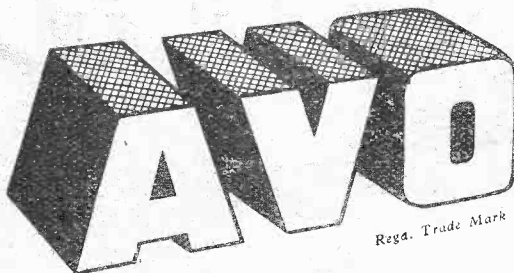
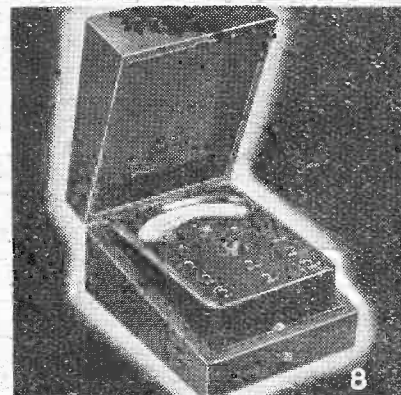
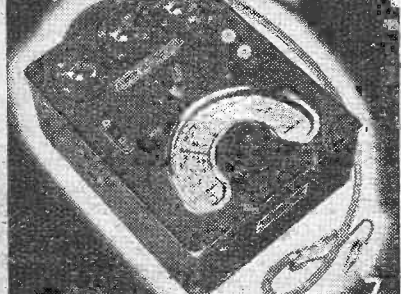
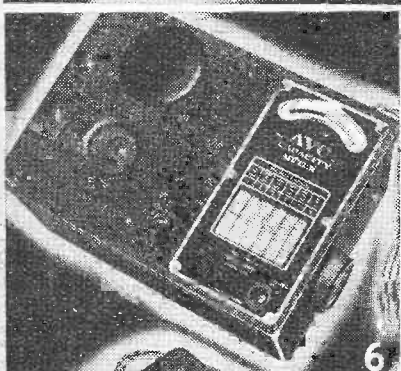
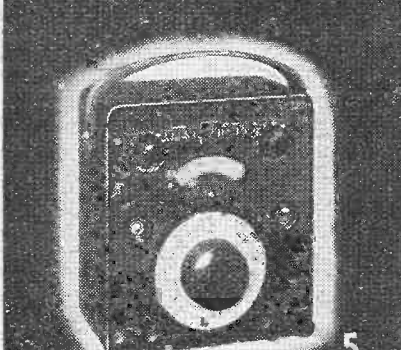
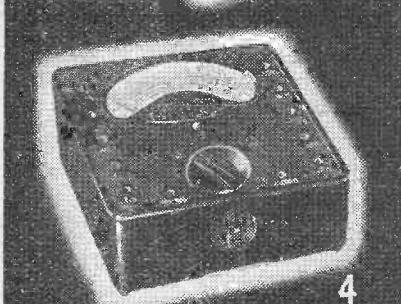
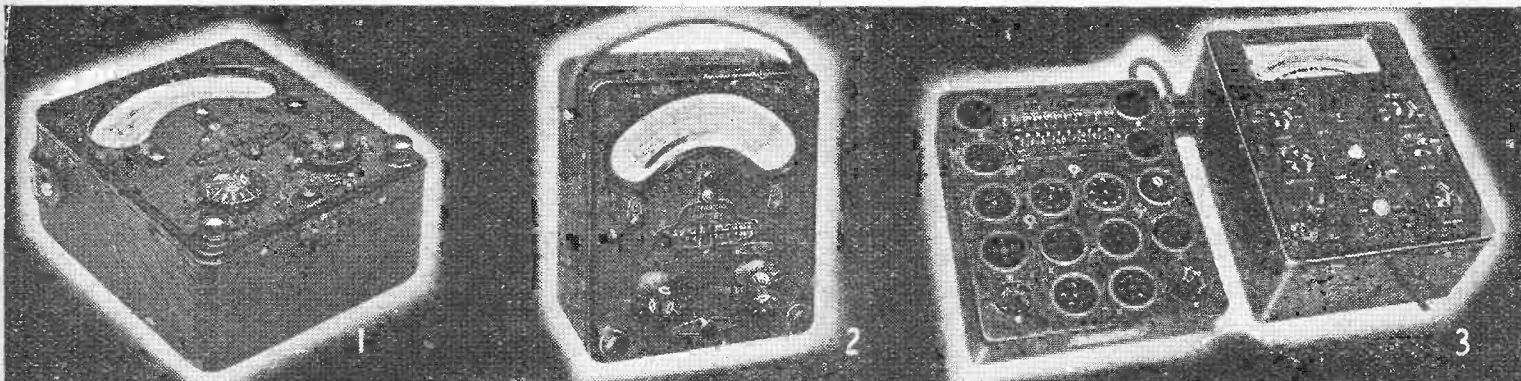

ELECTRICAL MEASURING INSTRUMENTS

BRITISH MADE

The Meters that Matter

1. Model 7 UNIVERSAL AVOMETER

A 46-range self-contained combination A.C./D.C. meter, providing direct readings of A.C./D.C. amperes and volts; resistance; capacity; audio-frequency power output and decibels. B.S. 1st grade accuracy. **16 Gns.**

★ 2. Model 40 UNIVERSAL AVOMETER

A 40-range self-contained combination A.C./D.C. meter, providing direct readings of A.C./D.C. amperes and volts; also resistance. B.S. 1st grade accuracy. (Supersedes the 36-range Universal Avometer.) **14 Gns.**

3. 'AVO' VALVE TESTER

Indicates mutual conductance direct in mA/v. ONE panel for all standard English, Continental and American valves. Any electrode combination can be set up for any valve base in the tester. Tests include Cathode/Heater insulation; diode and rectifier emission; filament continuity and electrode "shorts."

Complete with Universal Panel **12 Gns.**
Universal valve panel alone **3 Gns.**

4. UNIVERSAL AVOMINOR

A 22-range A.C./D.C. moving-coil precision meter providing direct reading of A.C. voltage; D.C. voltage; current and resistance. With leads, and interchangeable test prods and crocodile clips. **£5.10.0**

★ 5. 'AVO' TEST BRIDGE

A simple self-contained 50-cycle measuring bridge of great accuracy. Six ranges cover direct measurement of all normal sizes of condensers and resistances. Includes power factor and leakage tests. Can also be used as a sensitive valve voltmeter, and for inductance measurement. **8 Gns.**

Write for comprehensive folder describing all 'AVO' instruments, and/or full technical details of any individual instrument in which you are particularly interested.

Sole Proprietors and Manufacturers:

THE AUTOMATIC COIL WINDER & ELECTRICAL EQUIPMENT CO., LTD.
Winder House, Douglas Street, London, S.W.1. Telephone: VICTORIA 3404/7.

THREE new instruments have been added to the world-famous 'AVO' range—a new 40-range Universal Avometer*—a new Test Bridge*—and a new Low Resistance Ohmmeter (not illustrated). They embody all those finer points of design and construction which have made 'AVO' instruments the choice of all who demand precision testing.

6. 'AVO' CAPACITY METER

Provides VISUAL indication of capacity direct in micro-microfarads. Also indicates condenser losses. Employs resonance method at radio frequency. Six ranges, from 0 to 0.1 mfd., selected by rotary switch. **£23**

7. ALL-WAVE 'AVO' OSCILLATOR

Covers CONTINUOUS fundamental frequency band from 95 Kc. to 40 Mc. extended to 80 Mc. by harmonic calibration. Accuracy to within 1 per cent. External modulation, internal modulation or R.F. signal at will. Battery Model (incl. batteries). **9 Gns.** A.C. Mains Model, **10 Gns.**

8. D.C. AVOMINOR

A high-grade 13-range D.C. meter providing direct readings of voltage, current and resistance. In case, with leads, and interchangeable test prods and crocodile clips. **45/-**

OTHER 'AVO' INSTRUMENTS

22 Range D.C. AVOMETER **9 Gns.** 'AVO' Low Resistance OHMMETER **42/-**
High Resistance AVOMINOR **£3.10.0** The AVODAPTOR **27/-**
9-pin AVOCOUPLER **12/6**
All 'Avo' Instruments available on Deferred Terms.

"RADIO SERVICING SIMPLIFIED"

This valuable text book gives practical information on the whole routine of testing present-day receivers. It deals fully with every prevalent source of trouble and clearly describes every test. An authoritative work of reference, it is acknowledged to be of great assistance to amateurs and service engineers alike. 150 pages, numerous diagrams and graphs. Price **2/6**. Post-Free **2/10**.

Keep abreast of **TELEVISION**

Visit the **G.E.C. STAND** at Radiolympia

There you will be able to view and examine the splendid G.E.C. Television sets now available—from the new ADD-ON Unit for 22 gns. to the magnificent TELEVISION AND ALL-WAVE AUTO-RADIOGRAM for 72 gns. You should make a special point of seeing the 0091 CONSOLE (illustrated).

0091 | **32**
GNS

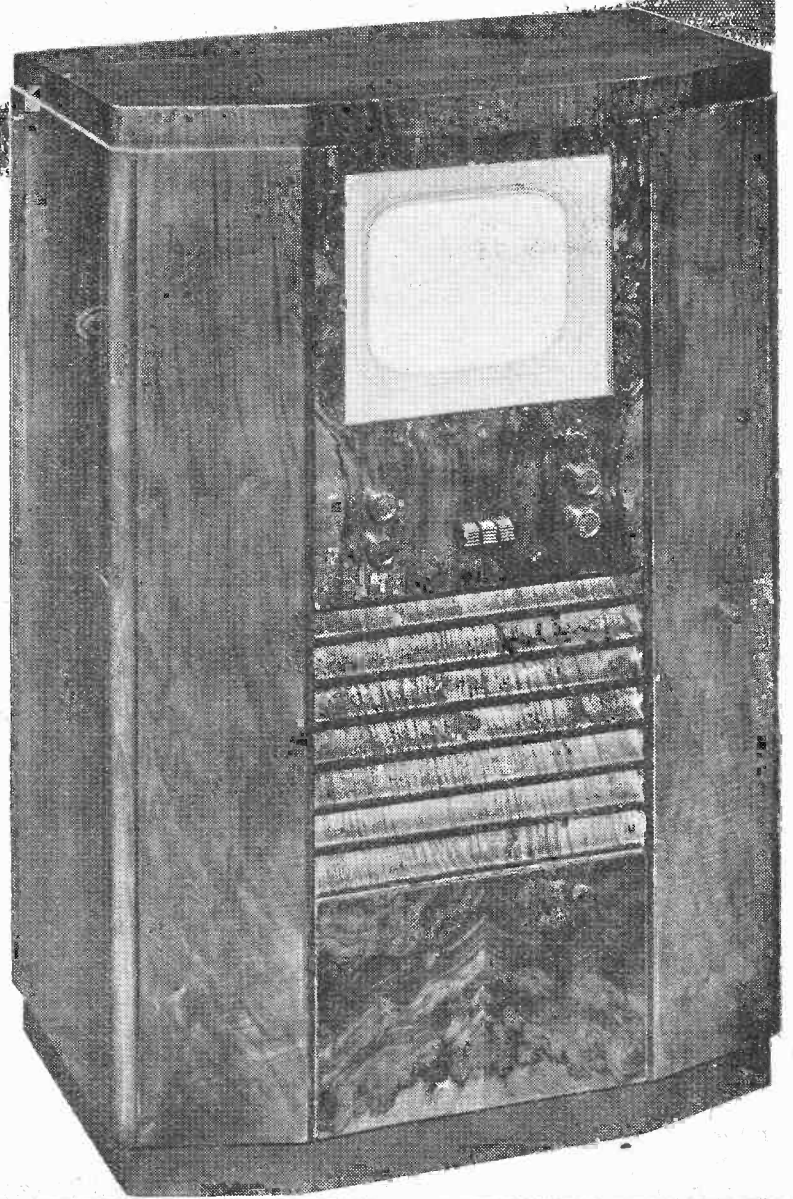

G.E.C.

RADIO & TELEVISION

Advt. of The General Electric Co., Ltd., Magnet House, Kingsway, London, W.C.2.

Mention of "The Wireless World," when writing to advertisers, will ensure prompt attention.

The Wireless World

THE PRACTICAL RADIO JOURNAL
29th Year of Publication

No. 1044.

THURSDAY, AUGUST 31ST, 1939

VOL. XLV. No. 9.

Proprietors : ILIFFE & SONS LTD.

Editor :
HUGH S. POCOCK.

Editorial,
Advertising and Publishing Offices :
DORSET HOUSE, STAMFORD STREET,
LONDON, S.E.1.

Telephone : Waterloo 3333 (50 lines).
Telegrams : "Ethaworld, Sedist, London."

COVENTRY : 8-10, Corporation Street.
Telegrams : Telephone :
"Autocar, Coventry." 5210 Coventry.

BIRMINGHAM :
Guildhall Buildings, Navigation Street, 2.
Telegrams : Telephone :
"Autopress, Birmingham." 2971 Midland (5 lines).

MANCHESTER : 260, Deansgate, 3.
Telegrams : Telephone :
"Iliffe, Manchester." Blackfriars 4412 (4 lines).

GLASGOW : 26B, Renfield Street, C.2.
Telegrams : "Iliffe, Glasgow." Telephone : Central 4857.

PUBLISHED WEEKLY. ENTERED AS SECOND
CLASS MATTER AT NEW YORK, N.Y.

Subscription Rates :

Home and Canada, £1 10s. 4d. ; other
countries, £1 12s. 6d. per annum.

As many of the circuits and apparatus described in these
pages are covered by patents, readers are advised, before
making use of them, to satisfy themselves that they would
not be infringing patents.

CONTENTS

	Page
Editorial Comment	195
Show Review: Technical Ten- dencies	196
New Television Aerial	206
Radiolympiana	208
"Effective Height" : What it Means as Applied to Receiving Aerials	209
Sideshows at Olympia	211
"The Wireless World" Pre-Set Quality Receiver (concluded) ..	212
Constant Sharpness of Tuning ..	215
Five-metre DX	216
Problem Corner	216
News of the Week	217
Short-wave Reception	219
Letters to the Editor	221
What is "Fluctuation Noise" ? ..	223
Random Radiations	224
Television Programmes	225
Recent Inventions	226

Editorial Comment

Broadcast Receivers : 1939-40

Trend of Design

THOUGH held under the shadow of grave international events, the Olympia Show is at least fulfilling one of its most important functions as the focal point of the wireless calendar. It has served to prevent stagnation, and to keep those responsible for the design of apparatus on the alert for new ideas.

Quite a minor detail of the less expensive type of broadcast receiver will illustrate the danger of accepting standardised practice as final. When "all-wave" sets with a single short waveband were first introduced the coverage was usually roughly from 16 to some 50 or 60 metres; the 13-metre band was omitted. Long after the difficulties associated with operation at the lower wavelengths had been overcome, designers still clung to the same waverange. Now confidence in the correctness of that choice is shaken by the introduction of at least one set with a single short-wave band of 12.5-35 metres. It may be argued that the 13-metre band which is thus included is of much greater value than the 49-metre band that is omitted.

Improvement of quality of reproduction, largely brought about by increased output power, is a tendency that will be generally welcomed, especially as it is now to be found in sets that are by no means costly. Ingenious methods of overcoming or at least minimising the natural limitations that restrict the performance of the smaller cabinet model have been devised.

Tone control has lately been in the limelight, and those who have followed the correspondence on "Reproduction Levels" in our columns will have

gathered that there is a school of thought holding that its use is wrong, at any rate for local-station "quality reception." Without entering into that controversy, it will be agreed by everybody that the crude form of control included until this season in the majority of cheap or medium-priced sets was hopelessly inadequate. The more refined systems to be found in some of the new sets do at least provide some scope for the listener who takes the trouble to learn how to use his receiver controls intelligently.

The new highly sensitive sets, in the design of which special attention has been paid to the short-wave bands, should serve as a useful link between the ordinary all-wave broadcast set and the "communication" receiver which, fascinating as it is, may perhaps be a little too complex for the majority of wireless users. These high-performance sets, and also the need for extreme stability in press-button tuning systems, account for the increasing use of low-loss ceramic insulating materials in the manufacture of various components.

The attractions of dry-cell LT batteries for portables and similar sets designed for intermittent use was urged in these pages even before recent valve developments made this an entirely practical proposition for the man in the street. The new "all-dry" portable should do much to establish the auxiliary set in its proper place.

Perhaps the most important tendency in the design of television receivers is towards the use of bigger tubes. The public still has the lingering idea that television pictures are "too small," and the change should help to forestall criticism on those grounds.

SHOW

Technical Tendencies

New Broadcast Receivers

"Solid Work Has Been Done"

THOSE who last year foretold a period of stagnation in receiver design as the result of a shifting of the focus of publicity from broadcast sets to television have been proved indifferent prophets by the course of events. Relieved of the necessity of appealing to the eye, designers have been able to concentrate on performance, and some really solid work has been done on the clearing up of background noise and the improvement of tone.

In place of the struggle to outdo competitors in the number of valves, gadgets and exclusive selling points, one finds general acceptance of the four- or five-valve superheterodynes, with or without a

separate AF valve being included to take its place. The input circuit of the triode section is connected in parallel with the volume control and due to the Miller effect in the valve it represents a capacity the value of which will depend upon the amplification factor. On a strong signal the DC component of the rectified signal will bias back the valve and reduce the amplification factor, and hence the capacity across the volume control. With a weak signal, on the other hand, the valve will reflect a high capacity and so reduce the high frequencies developed across the volume control. Another interesting feature of this set is that the AF amplifier is also controlled by the AVC bias.

Successive economies during past years in the proportion of cost allocated to the output stage and loud speaker have been proved bad business and the pendulum

has swung in the opposite direction. There is now keen competition to provide the finest possible quality of reproduction, and many of the current table models give results every bit as good as last year's consoles or radio-gramophones.

A battery receiver with an unusual circuit, the Cameo Model AWB, in which the triode section of the second detector is used for noise suppression and AVC is applied to the AF amplifier.

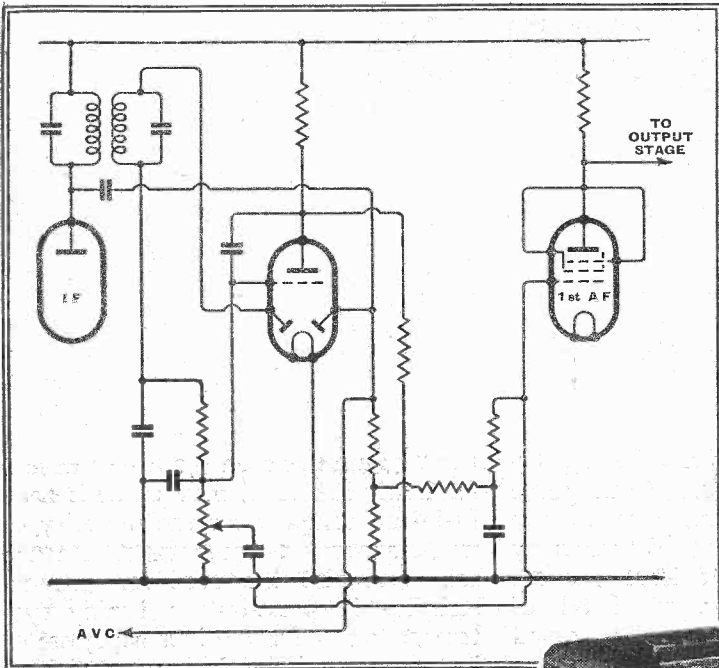

stage of RF amplification, as the circuit giving all the range and selectivity required by the average listener, and a concerted effort to make it as pleasant to the ear as it has always been to the eye.

Every effort is being made to rid the set of extraneous noises of all kinds, and the widespread use of valves designed to give the maximum signal-to-noise ratio is significant. Automatic noise suppression circuits are coming to the fore again, and a simple but effective method is to be found in the Cameo Model AWB designed by Gordon Elf, Ltd. In this superheterodyne receiver the triode portion of the second detector stage is allotted to noise suppression instead of AF amplification, a

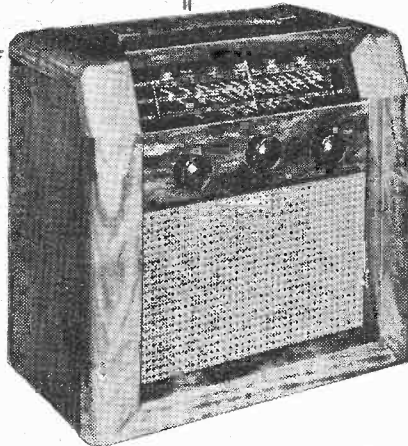

The improvement is due primarily to the general increase in the power-handling capacity of output stages; the 3 watts,



Special Report Compiled by the Te

which was thought adequate two years ago, is found only in the cheapest models. No receiver with any pretensions to quality claims much less than 5 watts undistorted, and the tendency is for powers to rise considerably above this figure. The H.M.V. Model 1200, with 10½ watts, and the G.E.C. Model 4010, with 12 watts, are good examples of the trend towards in-

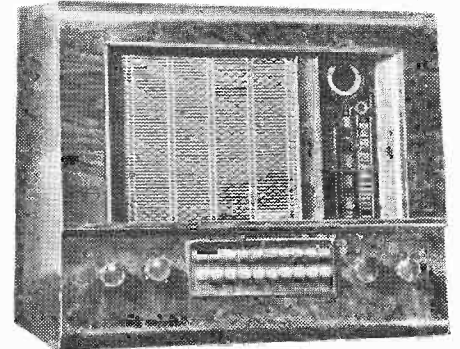

A 9 kc/s whistle filter is included in the Bush PB65.

creased power output in the better class of table models. Even higher ratings are to be found in the Alba Model 855 (16 watts) and Burndept Model 290 (18 watts).

There is evidence also that manufacturers are giving more attention to the reduction of harmonic distortion and that this drive is resulting in a return to the triode as an output valve. - Cossor, who have consistently held to this type in many of their receivers, are using it in the Models 70 and 71, and in the Bush Model PB63 triode valves are used throughout the AF portion of the circuit. To compensate for the lower amplification available an additional triode stage has been inserted as a "driver" before the output stage.

Next in importance to the improvements in output circuits is the work that has been done on tone control. In place of the crude resistance-capacity circuit giving a wholesale cut in the treble which extends well down into the middle register, scientifically designed tone controls, usually with four positions, give exactly the right frequency response for the recep-



Technical Staff of "The Wireless World"

tion conditions which fall under the headings of "High-Fidelity," "Normal," "Foreign" and "Long Distance."

In the McMichael sets a switch effects suitable combinations of two degrees of selectivity in the IF stages with bass "boost" by selective negative feed-back in the output stage. Ekco favour a continuously variable tone control which simultaneously adjusts bass and top lift networks included in the negative feed-back circuit, while in the G.E.C. sets adjustment is made for both bass and top in the AF coupling circuits after a general increase of overall amplification. The new Philips tone control is designed to give a sharp cut-off of high frequencies without affecting the middle register. Instead of returning to earth, the by-pass circuit across the anode of the output valve diverts the high-frequencies into the negative feed-back circuit, thus giving a much steeper cut-off. The normal feed-back is variable and is coupled to the volume control in the latest Philips set. Back coupling is greatest when the volume control is turned down on a strong local signal; with the volume control at maximum on weak stations, feed-back is reduced and full amplification restored to the circuit.

The introduction of 9 kc/s whistle

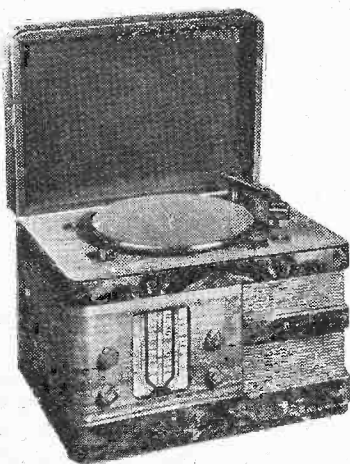

McMichael table model radio-gram. Model 903.

REVIEW

Revealed at Olympia

filters in standard production models is indicative of the extension of the usable frequency range, and the Ekco PB515 and Bush PB65 may be quoted as examples. Ten-inch loud speaker diaphragms are the order of the day in table models, and with the judicious lifting of bass in the circuits, really good low-frequency response free from the defects of resonance is obtained from receivers such as the R.G.D. 166.

So much for the table model sets which form the backbone of the industry. What of the developments in other directions? The table model radio-gramophone can

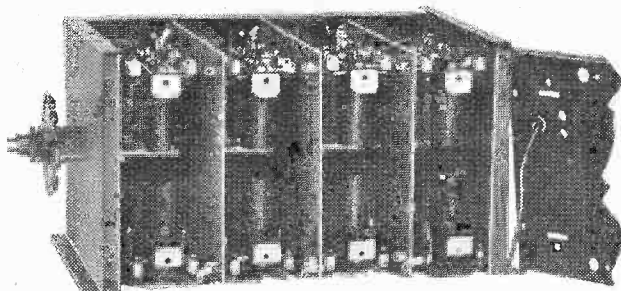

Short-wave coil assembly in the Murphy 76.

hardly be hailed as new, but the McMichael Model 903 and the Decca 39TGM point to a revival of interest in what is undoubtedly a very attractive type.

There is also a tendency to separate mutually conflicting interests in broadcast listening and to provide, within a given price limit, specialised receivers for good quality reception of signals of outstanding programme value or, on the other hand, highly sensitive sets for long-distance short-wave transmissions. The Murphy 74 and 76 are good examples of this policy. In the latter, separate tuned circuits are allotted to each of the principal short-wave broadcast

Individual calibration of short-wave stations is a feature of the Pye "International" tuning dial.

bands and the tuning of each band is expanded to the full depth of the tuning scale.

The Pye "International" is another receiver in which band spread tuning has been applied in the short-wave range. Each band is calibrated not only in wavelengths but with the settings and names of

the principal stations in their correct order. As far as we are aware, this is the first instance of accurate station calibration on short waves. The oscillator circuit for each band is tuned by a stable fixed capacity in conjunction with a separate short-wave variable section of the main tuning condenser. Separately adjusted image rejection circuits are also provided for each waveband.

Highly efficient short-wave circuits are also to be found among the products of the luxury set manufacturers. The export model of the de luxe McMurdo Silver receiver employs coils wound on polystyrene formers. The windings of the aerial transformers are separated by electrostatic shields and on the lowest waveband unity coupling is achieved by

passing the primary through the silvered copper tube which forms the secondary. To preserve the high "Q" of the coils the connections to earth and to the tuning condenser are made with multi-strand silvered braid. Another interesting feature of this particular set is a direct-coupled system of AF amplification giving a considerable extension of level frequency response at both ends of the scale.

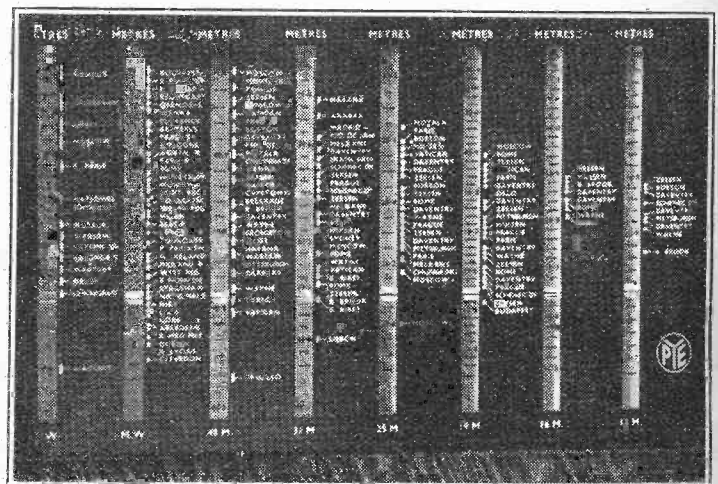

The Dynatron "Commander" chassis shown on the Keates-Hacker stand is virtually three receivers in one. A straight circuit is provided for local station reception, a "normal" superheterodyne with a redesigned variable selectivity system giving true band pass characteristics even at 4 kc/s band width is employed for general

Show Review—

reception, and on short waves a double superhet. circuit with *two* RF stages is brought into operation. There are twenty-

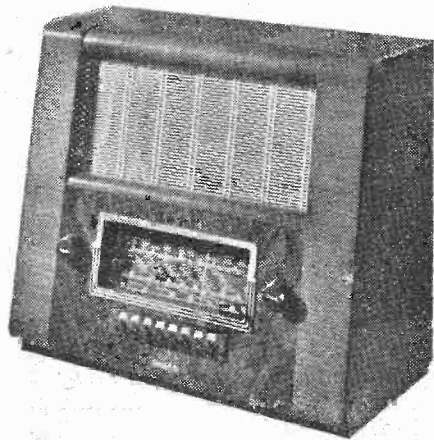

Philco B.2 all-dry battery superhet with push-button tuning.

five valves in the circuit, four of which are triodes working in push-pull to give an undistorted output of 20 watts. Refinements include noise suppression circuits, a manually operated adjustable whistle filter and a cathode ray indicator for grid current in the output valves. The chassis is built on a machined aluminium casting and costs £165.

The humble portable has this year provided one of the most interesting and practical technical developments. New valve types have been introduced which enable the filament current to be derived from dry cells which in some cases are built into a unit with the HT battery. The capacities of both batteries are adjusted so that they run down together and a life of 250 working hours may be taken as an average. Usually the HT battery is arranged to run down just before the LT, as the efficiency of the valves is quickly affected by a fall in the filament volts, which should not drop much below 1.1 volt. With the standard batteries available these conditions will be met by allowing for an LT current of 0.25 amp. and an HT current of 10 mA.

The circuit usually adopted is a 4-valve

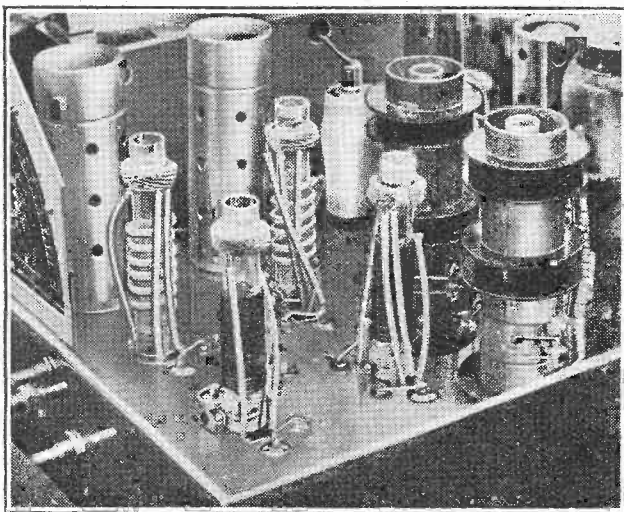

superhet., and the Philco P429 was one of the first portables of this type to be produced in this country. Other notable

examples shown at Olympia are the Decca-Brunswick Model 42 and the Vidor Model 320. The advantages of all-battery operations are equally important to the country dweller, and there are signs that we shall see a number of table model receivers working on this principle. In the meantime, for those who wish to acquire a set of this type, there are, among others, the Ferranti Model 539 and the Philco B2, the latter with push-button tuning.

The alternatives of dry battery or accumulator supplies for LT current are available in the Cameo Model ARP. This set uses standard 2-volt valves which may be run direct from an accumulator, or from a 3-volt battery through a barrier lamp. Yet another alternative source of power supply is provided in the

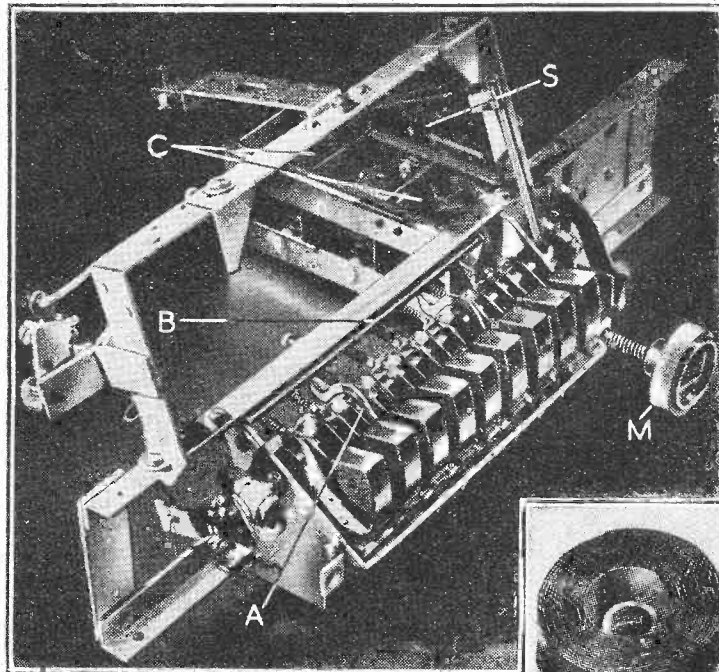

Philips push-button tuning system with automatic wave-range selection, and (inset) the modified condenser vanes giving straight line frequency characteristic.

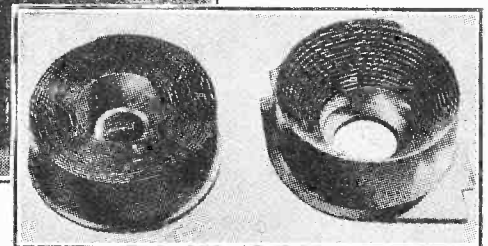

Philco "Twin Miracle" portable. This includes a rectifier and smoothing circuits for operating the set from AC/DC mains in addition to the self-contained all-dry battery supply. A relay is included which

automatically changes over the supply circuits and keeps the set operating without any break in the programme if the mains supply fails.

Push-button tuning systems, many of which were rather hurriedly produced for last year's show, have overcome their teething troubles and have been further simplified in operation. Most of the permeability-tuned sets now make use of the improved switching arrangement which

In the McMurdo Silver de Luxe export model the short-wave coils are wound on polystyrene formers.

automatically switches on the set when any button on the receiver is pressed, and in the Murphy remote control system a

motor is used to select the appropriate pre-tuned circuits. The simpler mechanical systems which call for separate operation of the wave range switch are generally supplied with much clearer indications of the waveband in use, and a good example is to be found in G.E.C. sets in which a "fluorescent" bar of colour shows immediately above the row of controls.

In the new Philips direct-action mechanical tuning system, wave changing is effected automatically by an auxiliary link motion associated with three of the operating keys. A rocker bar B connected to the wave-range switch S is pulled forward by the claw A when one of these keys has been set up for a long-wave station. When the key is required for a medium-wave station the claw is

dropped and a second bar, not shown in the photograph, is pushed forward by a cam underneath the key which restores the switch to the medium-wave position. A special ad-

justing tool is provided, and the wave range obtained depends on whether or not the key is depressed when the adjustment of the station is made. The tuning condenser C is of the linear action type used last year, and for manual operation the vanes are engaged by a screw thread operated by the knob M. The spiral vanes in this year's type are shaped to give linear frequency response.

Important modifications have been made to the Ekco motor-driven automatic tuning system. The contacts of the homing disc are now provided by metal rollers, designed to overcome the inaccuracies which result from sparking and burning of the edges of discs of the normal type. New selector clips with machine-cut key-type contacts have been developed for use with the new roller contacts, and high accuracy of location is claimed.

The driving mechanism has been speeded up, and is provided with a reverse-vernier device of clever design. The gear wheel G driven by the motor pinion carries a bridge B with a peg P engaging in a slot in the link L. When the

Show Review—

motor is first switched on the peg travels to the bottom of the slot and drives round the bracket U, to which the tuning condenser is coupled, at the same speed as G. When the contacts on the homing disc reach the appropriate selector clip they overshoot slightly and the motor is reversed. The peg now travels along the slot and imparts an angular movement to

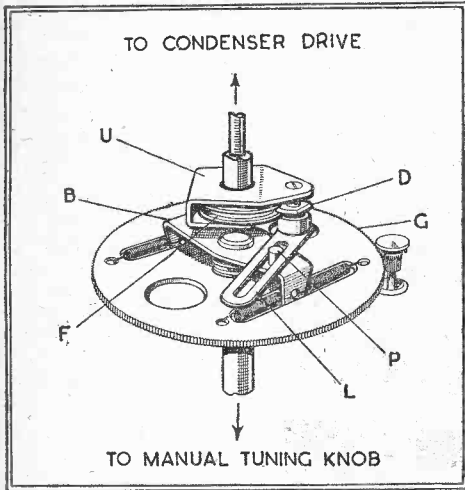

Reverse-vernier mechanism in the Ekco high-speed motor tuning system.

the link L, thus engaging the friction wheels D and F. Since F is fixed the rotation imparted to U and the condenser drive is opposite to the direct drive and the gear ratio is enormously increased by the combined action of the link motion and the reduction introduced by D and F. Incidentally, the edge of the friction wheel D is cut away so that it disengages when the peg is in the bottom of the slot during the high-speed drive.

The final centring between the roller contacts of the homing disc is made with such precision that the need for AFC circuits in the receiver is eliminated. Adequate steps have been taken to offset the possibility of increased wear with the higher initial motor speed and suitable shock-absorbing springs have been included in the drive.

In principle the waveband selector mechanism, termed by Ekco the "Radio Brain," remains the same as last year, but a corresponding increase in speed of operation has been met by the introduction of ball contacts.

Special apparatus for life-testing of automatic tuning systems was shown in action by Ekco, Philips, and a number of other firms and the severity of the tests applied should convince sceptics of the reliability of this year's designs.

Television Receivers

No Standardisation Yet

A TREND in the development of television receivers which was clear last year has now become normal practice—the use of electromagnetic deflection and focusing instead of electrostatic. Nearly all the receivers are of the magnetic type. This is not necessarily due to any

inherent technical superiority of the magnetic system, but usually to the economic element. Most people find it easier and cheaper to obtain a given standard of performance from a magnetic tube than from an electrostatic. Not everyone does, however, and electrostatic tubes are still to be found, especially in the smaller types.

Probably the most obvious trend this year is towards the use of larger tubes; there are now fewer sets with tubes less than 7in. diameter and more with tubes over 12in. Tubes of 14in. and 15in. diameter are, in fact, not uncommon, but the most usual sizes are still 9in. and 12in.

The superheterodyne is still the favourite type of vision receiver, although there are quite a number of straight sets to be found. The usual procedure is to employ one RF stage, frequency-changer, three IF stages, a diode detector, and one VF stage. Insofar as television has achieved any degree of standardisation, and it is still very small, it is in this valve arrangement. But although this may be the basis of many vision receivers there is a much greater lack of uniformity about the arrangements for sound reception. It is usual to make the early stages function for both channels, but the number of stages in common varies in different sets. There is probably a greater tendency than

finds the arrangements necessary for operating the sound receiver alone—a facility which most sets now include. It is clearly wasteful if one has to operate the whole vision equipment if television sound only is wanted.

The small degree of standardisation to be found precludes any general discussion and it is much more informative to consider in some detail a few representative examples of modern practice. Murphy Radio, for instance, adopt a superheterodyne. The RF stage is followed by a two-valve frequency-changer and an IF stage which has a sound rejector in its cathode

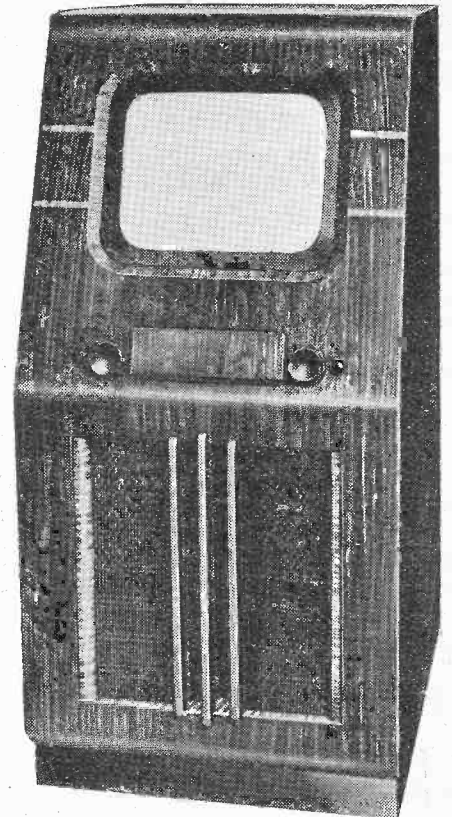

In the Pye receiver "occasional controls" are behind a small panel.

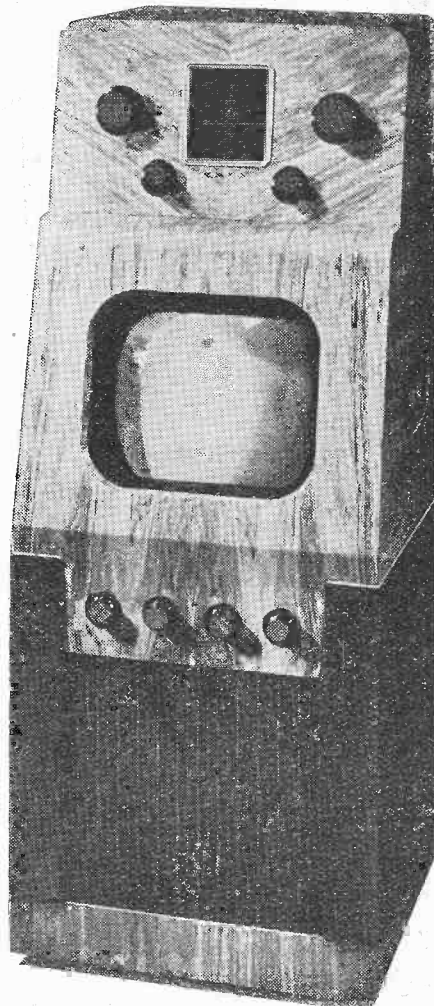

Murphy V88 receiver with all-wave sound equipment.

circuit; these three stages function on both sound and vision channels. The signals are then separated and each has a further IF stage of its own. The vision channel feeds a diode detector which in turn feeds a VF stage. The tube is fed from the anode of this and the sync separator, which consists of a duo-diode, from the cathode. Gas-triode time-base oscillators are used with tetrode amplifiers feeding the line and frame deflecting coils.

In the case of the sound channel, following the common first IF stage the signal passes to a second stage and thence to a diode detector and noise suppressor. The AF output is taken to the last IF valve, which is thus reflexed, and finally to the output pentode.

The noise suppression circuit is an interesting variation of the common peak limiting circuit in which a diode is biased so that it is non-conductive over the range of signal modulation voltages, but conducts and virtually short-circuits the output on higher voltage peaks. In this case a fixed diode bias is not used but the signal itself

before to make the vision and sound receivers entirely separate, since this simpli-

Show Review—

provides the bias. The bias is actually the signal derived from another point in the circuit and fed to the diode through a delay network. It is claimed that much more effective noise suppression is obtainable in this way.

In its smallest form this receiver is the V84 giving a picture 7½ in. by 6 in., but it is available with substantially the same circuit with a 12 in. tube.

A receiver of an entirely different type is the Pye. This is a straight set with five RF stages using band-pass intervalve couplings. An anode-bend detector is used and its output is fed to the cathode of the CR tube. A duo-diode sync separator is used and is followed by an amplifier. A single hard valve forms the frame time-base oscillator, but for the line scan the oscillator, which is again a hard valve, is followed by an amplifier. Magnetic deflection and focusing are employed.

An entirely separate receiver is used for sound and this has two RF stages, detector and output valve. The mains equipment for vision and sound channels is also separate.

One very interesting feature of this apparatus is its mechanical arrangement. All the "occasional controls" are mounted on the front of the chassis and accessible from the front through an opening which is normally covered by a small hinged lid. For servicing, it is only necessary to undo two screws. The chassis then slides backwards and downwards on sloping supports until two large hooks on its rear edge engage with a horizontal bar across the cabinet. The chassis is then

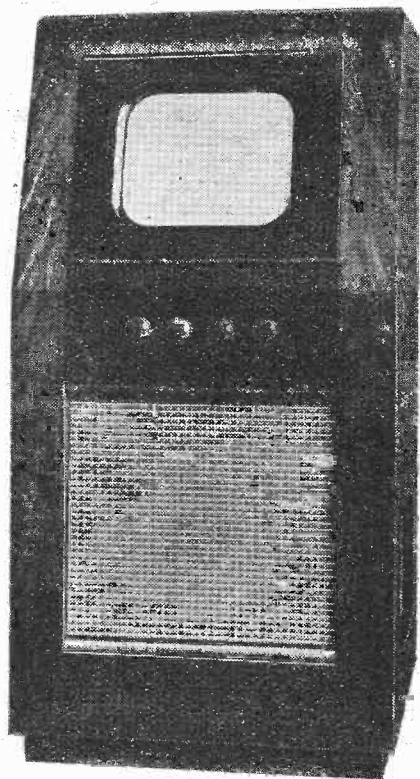

Ekco Model TSC902.

pivoted on this bar and can be swung right out and examined and operated in an inverted condition. Folding struts for hold-

ing the chassis in this position are even provided.

The model 12C has a 12 in. tube and is also available with an all-wave receiver or with a radio-gramophone. There is also a smaller set, the 9C, with a 9 in. tube.

Baird also adopt a straight set for vision and use two RF stages with secondary emission valves, a diode detector, and one VF stage. A triode sync separator is employed and feeds the time-base oscillators through separate diodes. Hard valves are used in the time-bases. There is one valve for the frame scan, and another for the line, but this is provided with a damping diode. The oscillators feed the deflecting coils without the intermediary of an amplifier.

A separate receiver is employed for sound and consists of a superheterodyne with a triode-hexode frequency-changer, one IF stage, duo-diode detector and AVC system, a pentode AF stage and a pentode output valve. This is a three-band broadcast set; for television sound the same receiver is used, but then the AF stage is reflexed and acts as an RF stage also.

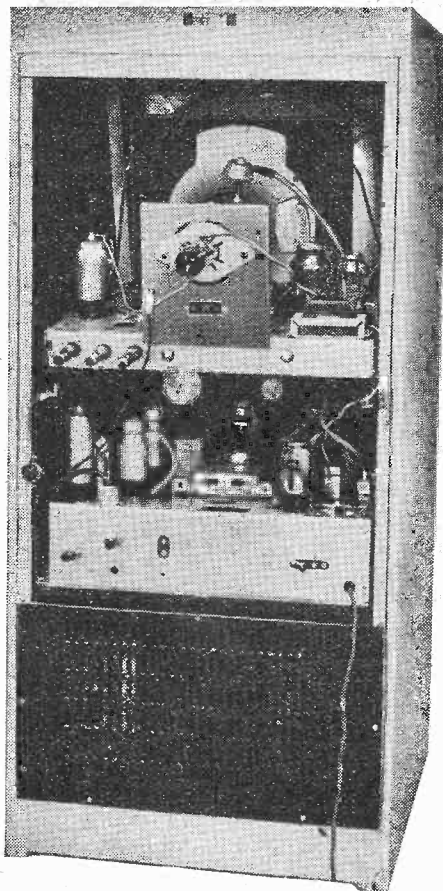

The Baird T27 television receiver.

This is the model T25 with a 12 in. tube. Both smaller and larger sets are available, with 9 in. and 15 in. tubes, and they are also available with provision for television sound only.

Bush receivers are again of the straight type. Three RF stages are used with a diode detector and one VF stage. Gas-triodes with pentode amplifiers are used in the time-base, however, and the 12 in. tube has electromagnetic deflection and focusing. Separate power units are employed

for the vision and sound receivers, the latter being a superheterodyne with push-button tuning.

Another adherent of the straight set is Ekco. Three RF stages, diode detector, and one VF stage are used. Band-pass coupling is employed and a wavetrap is included in the suppressor grid circuit of the second RF valve in order to avoid in-

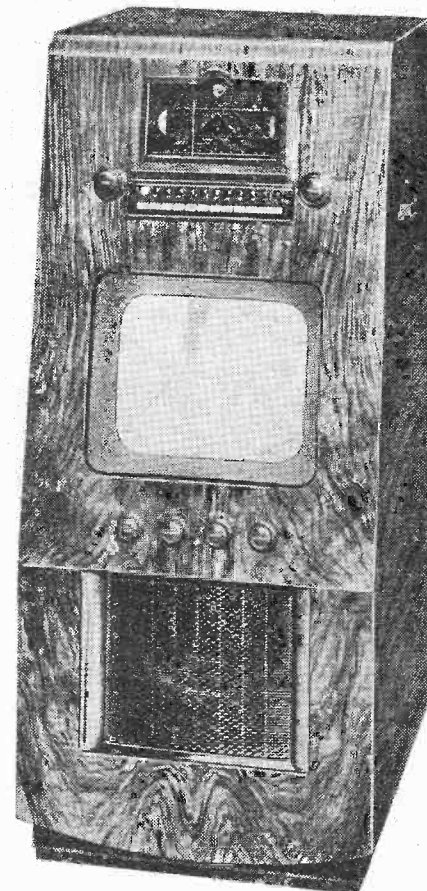

H.M.V. 1850 all-wave broadcast and television receiver.

terference from the sound channel. The contrast control varies the bias of both control and suppressor grids of the first stage, this dual control being adopted in order to maintain the input resistance and capacity of the valve at a nearly constant value.

Two diodes and a pentode are used for the separation of the sync pulses and their subsequent amplification and in the time-bases gas-triode saw-tooth oscillators are used. The tube is of the electromagnetic type.

For sound reception a separate receiver is used with two RF stages followed by a duo-diode-triode. In the case of "add-on" units the output of this valve is brought out for connection to the pick-up terminals of any standard broadcast set. In other models it feeds a pentode output valve.

Both H.M.V. and Marconiphone adopt the superheterodyne and have very similar receivers. The details vary somewhat in the different models, but the H.M.V. 1802 and the Marconiphone 712 both start with an RF stage and have a triode-hexode frequency-changer followed by two IF stages. All these stages are common to both vision and sound channels and their

Show Review—

separation is accomplished after the second IF stage. Each channel then has a further independent IF stage.

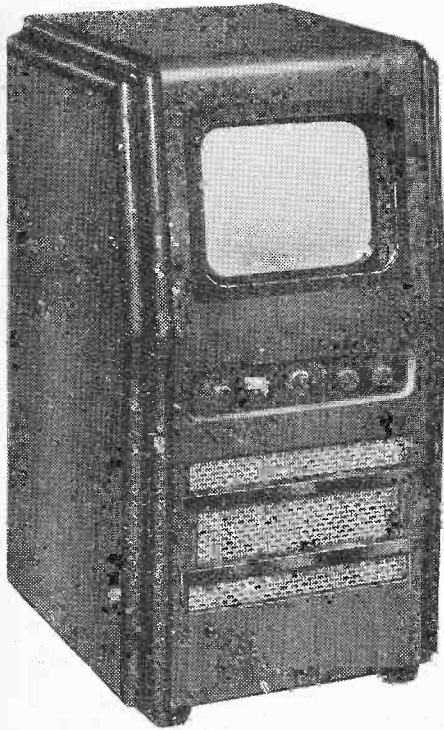

The Cossor 131 with 13½in. tube.

The sound IF is fed to a duo-diode, which acts as a detector and noise suppressor and is followed by a triode AF amplifier and tetrode output valve. On vision a diode detector is used with one VF stage and the output of this is fed to the cathode of the CR tube. A diode followed by a limiter is used for sync separation.

Hard-valve saw-tooth oscillators are used in the time-bases and are provided with tetrode output valves. Focusing and deflection are both electromagnetic. The tube has a diameter of 14in. and so gives a picture 11½in. by 9½in.

Cossor are also adherents of the superheterodyne. The model 131 is for television only and has a 13½in. tube; the pic-

somewhat smaller picture than usual for the tube diameter a much flatter picture is secured. Magnetic focusing and deflection are adopted and a permanent magnet is employed for focusing, an arrangement which is also adopted by Ferranti. Rough adjustment of the field is obtained by a sliding sleeve on the magnet and precise adjustment by a small variation of gun volts.

The receiver has one RF stage and a triode-hexode frequency-changer followed by three IF stages for the vision channel and two for the sound. The output of the latter is taken to the detector, with which is incorporated a noise suppression circuit. The output valve is a pentode. On the vision side a full-wave diode detector is

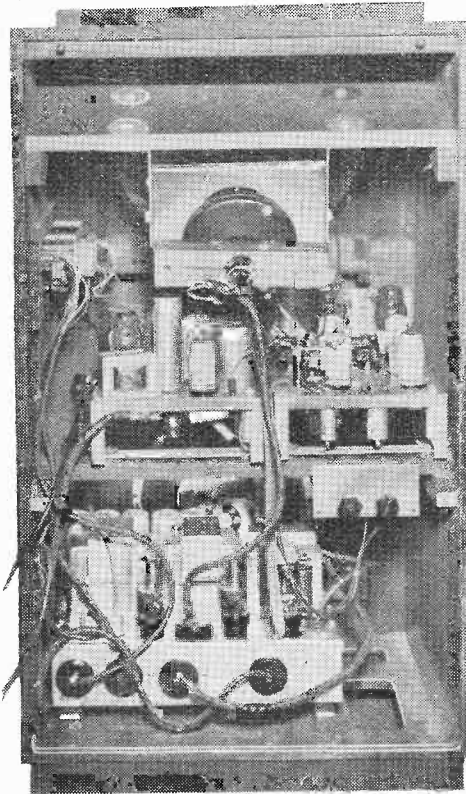

The interior of the R.G.D. 393 television receiver.

used, followed by one VF stage, and a split-anode pentode for sync separation. Hard-valve saw-tooth oscillators are employed with pentode amplifiers.

A similar receiver incorporating an all-wave broadcast set is also available. This is the model 151. It has a 15in. tube giving a picture 12in. by 10in. and for broadcast reception the major part of the television sound equipment is used and preceded by a frequency-changer. Push-button tuning is provided with permeability trimmers and allows of four MW and two LW stations being obtained. Provision is made for manual tuning over three wavebands.

Superheterodynes are used by the G.E.C., but the method of deflection varies. In the case of the smaller models electromagnetic deflection is used. These are the BT.0091 and BT.0092 and are

similar save that the former provides only television sound while the latter includes a broadcast set. They have a 9in. tube giving a picture 7½in. by 6in. The large receiver, BT.0124, has a 12in. electrostatic tube and gives a picture 10in. by 8in. This model includes an all-wave receiver and gramophone equipment with an automatic record-changer.

In the R.G.D. superheterodyne the frequency-changer, which is preceded by an RF valve, is of the two-valve type and consists of an RF pentode mixer with a separate oscillator. The sound and vision channels separate immediately after the mixer and on sound there are an IF stage, duo-diode-triode, and pentode output. On vision three IF stages are adopted with diode detector and one VF stage. The sync separator comprises two diodes with an amplifier for the frame pulses. The saw-tooth oscillators are gas triodes with pentode amplifiers. Magnetic deflection is used. There are two models—the 393 with a 12in. tube and the 391 with a 9in.

Decca models are superheterodynes and magnetic deflection is used with a 12in. tube. There is an RF stage and sound and vision are separated just after the frequency-changer. Two IF stages are used on vision and there is one VF stage.

The Philips and Mullard receivers are unusual in that only the RF stage is common to vision and sound. Two frequency-changers are used, the vision IF being taken from one and the sound IF from the other. Secondary emission valves are employed. The picture size is 7½in. by 5½in. in the case of three models, but there is also one giving a picture 10in. by 8in. and in addition this firm makes a projection model with a picture 18in. by 14½in.

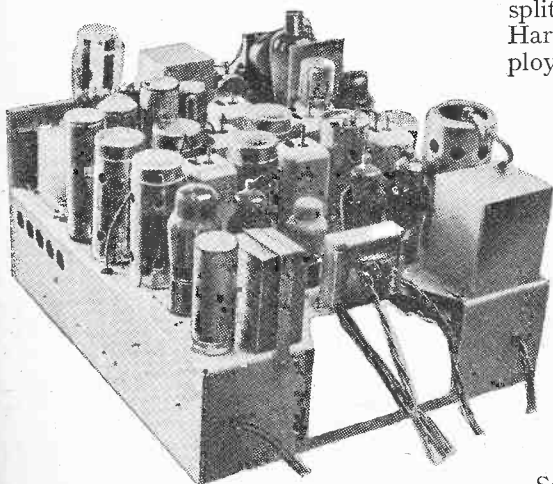

Chassis of Marconiphone television receiver.

ture obtained is 10in. by 8in., the usual size for a 12in. tube. By designing for a

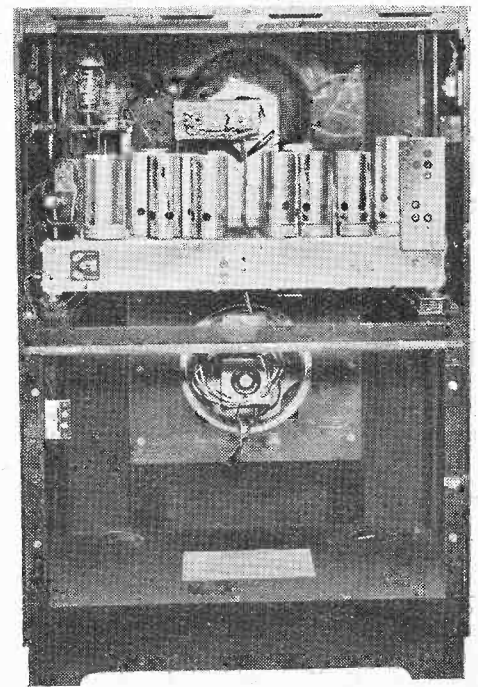

G.E.C. Type BT.0092 with all-wave broadcast set.

The Scophony receivers differ from others in being mechanical. The smallest gives a picture 18in. by 14½in. The vision

Show Review—

receiver is a straight set with two RF stages and a diode detector followed by a VF stage. Then comes a DC restoration

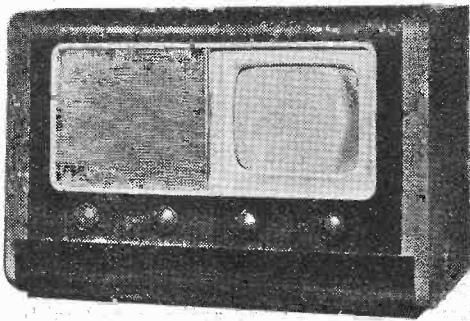

Philips 2405 table-model television set.

circuit and the modulator for the oscillator which drives the quartz crystal of the light control cell. The sync pulses are separated and amplified, and used to control the motors driving the scanning drums.

Electronic Devices

Valves—CR Tubes—Multipliers

SO far as valves are concerned the trend of development has now taken two distinct branches and although there is a possibility that in the future these branches may reunite, it seems more probable that they will continue to diverge. The two branches are television types and ordinary receiving valves, and the fact that their development is proceeding on different lines does not mean that they have not some improvements in common nor that their uses are rigidly confined to their classification. So-called television valves are sometimes used in apparatus other than television receivers.

The general trend among television RF pentodes is towards higher values of mutual conductance with low values of

tance and with a given valve construction the one increases as the other decreases. New forms of construction are being adopted, therefore, in order to improve matters, and some of the latest types have perhaps the same mutual conductance as older specimens, but a much higher input resistance.

This increase of resistance is obtained by reducing the length of the internal leads of the valve, and this also reduces the capacities. The methods adopted by different makers, however, vary considerably. Some firms use a modified pinch for the electrode supports, others abandon it and use a short glass seal or even a glass ring forming part of the envelope.

The Mazda SP41 and SP42 have been available some time and are, consequently, quite well known; they have mutual conductances of 8.4 mA/v. and 9.0 mA/v. respectively, and the former has an input resistance of some 2,300 ohms at 45 Mc/s. The valves have the Mazda octal base. Marconi and Osram have the Z62 with a mutual conductance of 7.5 mA/v. and an input resistance at 40 Mc/s of 4,000 ohms; it is a pentode with the International octal base.

Mullard have two types. One is of more or less conventional type. This is the EF50, with a mutual conductance of 6.5 mA/v. It is a single-ended all-glass valve with a "ring" construction and 9-pin base. The other is the EE50 with a mutual conductance of 14 mA/v. This is of similar construction, but is a secondary emission valve.

Apart from RF pentodes, new television valves are chiefly low-resistance and low-capacity diodes. Mazda have the D1 with a 4-volt 0.2 A. heater, while Mullard have the T4D and EA50 with 4 v. and 6.3 v. heaters respectively, and the Marconi and Osram type is the D43 rated for 4 volts.

Listed for television application, although by no means confined to this, is a new triode-hexode frequency-changer, X62. This is a Marconi and Osram valve and has a conversion conductance of

A duo-triode, the BL62, with separate cathodes, is another valve having interesting possibilities, as is also the U134. This is a most unusual valve since it consists really of two separate full-wave rectifiers, each with a rating of 350 v. 100 mA., in one envelope.

Cossor also have a triode-hexode of high conversion conductance, the 4THA, and a triode-pentode which is not intended to act as a frequency-changer. This is the 4TP and it is essentially a time-base valve. The pentode is designed to act as a discharge valve and the triode as a paraphase amplifier.

Turning now to non-television types, probably the most striking development is the production of valves for dry battery LT supply. These valves have 1.4-volt filaments and most types consume 0.05 A., but output pentodes naturally take rather more. Tungsum have a range with the American octal base which are the counterparts of American types. Mazda valves of this rating, however, are provided with

the Mazda octal base. The range includes a heptode frequency-changer, an RF pentode, a single-diode-triode and an output pentode, and the valves are rated for a 90-volt HT supply. The valves, of course, have lower values of mutual conductance than the ordinary 2-volt type.



Mazda SP42 RF pentode.

Marconi and Osram adhere to this latter rating and have a triode-hexode which consumes only 0.2 A. filament current. This is the X24, and in a new output tetrode, the KT24, the current has been kept down to the same figure. The HD24 duo-diode-triode takes only 0.1 ampere.

These firms have also added high-slope valves to their 6.3-volt range. There are the KTW61 RF tetrode and the KT61 output tetrode—the latter having a mutual conductance of 10 mA/v. A complete range of 6.3-volt valves taking only 0.16 A. current has been introduced; this is the Uniwatt range, and in view of the low current it is of particular interest for car radio.

Changes have also been introduced in Cossor battery valves. Probably the most noticeable is the 210 VPA, which is substantially the same as the older 210 VPT, but has lower inter-electrode capacities.

A development of considerable interest is the electron multiplier. Although most obviously useful for television, it has many other applications, and a six-stage model has been developed by Bosch Electronics and is known as the Augetron.

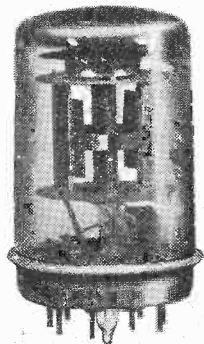

Mullard EF50 all-glass valve.

(Right) Television chassis with Bosch Electronics Augetrons.

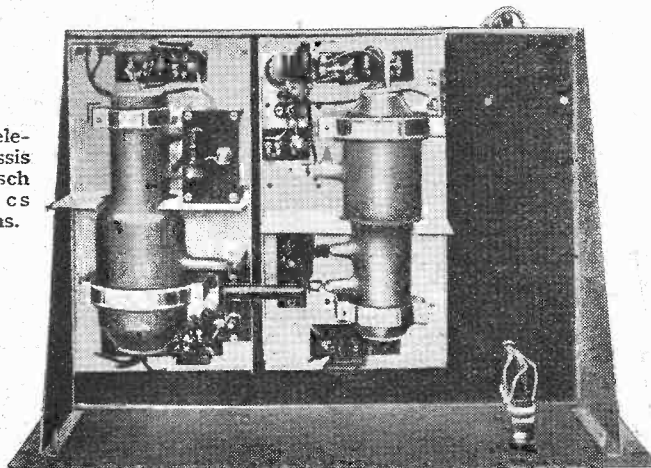

interelectrode capacity. This, however, is coupled with a marked effort, present in all classes of RF pentode, to obtain a higher input resistance at ultra-high frequencies. At these frequencies the limit to possible stage gain is set by the product of mutual conductance and input resis-

1.75 mA/v., while the triode section has a high mutual conductance. Of particular interest is the fact that the cathode has two separate connections to separate pins in the base in order that interaction between the various circuits may be kept at a minimum.

Show Review—

It requires some 300 volts per stage, or nearly 2,000 volts per tube. This high voltage does not seem of great drawback for television, since there appears to be no reason why it should not be obtained

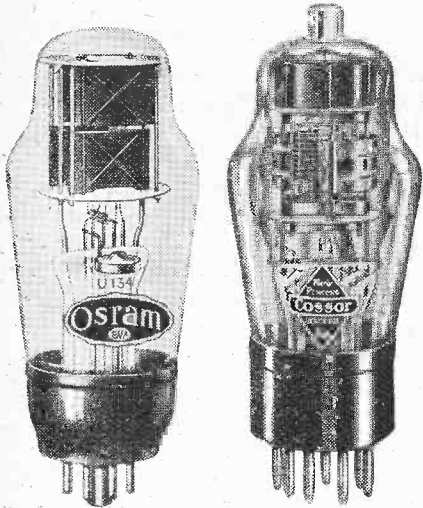

Osram U134 double full-wave rectifier, and the Cossor 302 VPB pentode.

from the CR tube's high voltage supply. The multiplier has an overall mutual conductance of 40 mA/v. and an input resistance of over 20,000 ohms at 45 Mc/s; a gain of the order of 1,000 times is realisable from a single multiplier.

Turning now to cathode-ray tubes, Mullard have both triode and hexode types in both 9in. and 12in. sizes. The triodes are the MW22/3 and MW31/5, while the hexodes are the MW 22/2 and MW 31/6. The hexodes have two anodes to one of which a potential of about 250 volts is applied. Both types are for electromagnetic deflection and focusing.

Mazda tubes are of the short type and again are for magnetic deflection and focussing, while Cossor have both electrostatic and electromagnetic types. Oscillograph tubes, as distinct from television types, are listed by most firms and have screens ranging from about 1½in. to 4in. in diameter. Cossor have a split-beam tube.

Marconiphone have a range of television tubes ranging from 5in. to 14in. in diameter. These are of the triode type for electromagnetic deflection and focusing. Hexode tubes for magnetic deflection but electrostatic focusing are also listed.

Components and Accessories

New Products Reviewed

FOR some time past now the components that have been shown each year at Olympia have fallen within one of two distinct categories. On the one hand there are those parts designed and produced exclusively for set makers, while on the other are the components available to home constructors. The

former are very largely sample productions showing the main features only, since modifications may have to be made to meet particular requirements.

So far as the broadcast listener is concerned their main interest lies in the ability to examine and appraise the technical skill and workmanship devoted to the many individual items that go to make up a modern broadcast set.

Press-button tuning systems can be divided into two main categories, those that operate on the principle of mechanically rotating the gang condenser and those that consist of a series of switches to bring into use circuits previously tuned to the desired stations.

Motor-operated condenser units are shown by Garrard and by Plessey, while examples of the mechanically operated condenser can be found on the Polar stand.

Switch units are being shown by Bulgin, Plessey, Polar and Wearite, the last-mentioned embodying permeability-tuned coils.

With the introduction of this system of tuning a demand arose for fixed and semi-variable condensers of high stability, that

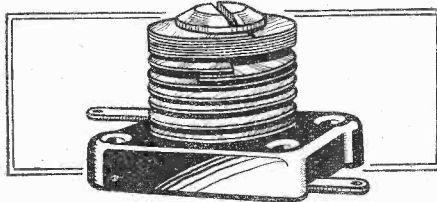

T.C.C. air-dielectric trimmer.

is to say, condensers that maintain their capacity unchanged over a long period and in varying temperatures. Actually this problem has occupied the attention of condenser makers for some time past, but even so improvements are still being made.

One method of construction is to deposit metal on sheets of mica, another is to use a base of ceramic material, while a third takes the form of air-dielectric condensers. Dubilier are showing examples of all three varieties and so are T.C.C. A series of metallised mica condensers, having protecting side plates and wire connections and with tolerances of two per cent. in capacity, have now been made available to the home constructor, while sundry improvements and extensions of range have been effected in other patterns.

There is a T.C.C. air-dielectric trimmer

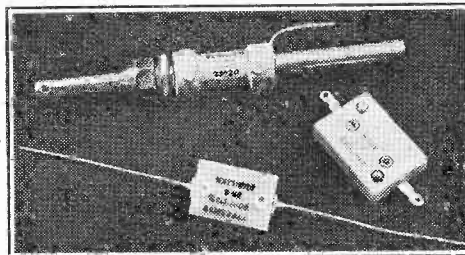

Dubilier air-dielectric trimmer and metallised mica condensers.

constructed on quite a new principle, as both moving and fixed vanes are cut in

the form of a continuous spiral, the former interleaving with the latter when the adjusting screw is rotated. The idle portion of the moving vane concertinas into a compact space at the top of the unit. A feature of the condenser is its very small size, as the base measures 1in. x ¾in. only.

Bulgin has an improved range of silvered mica condensers, while other

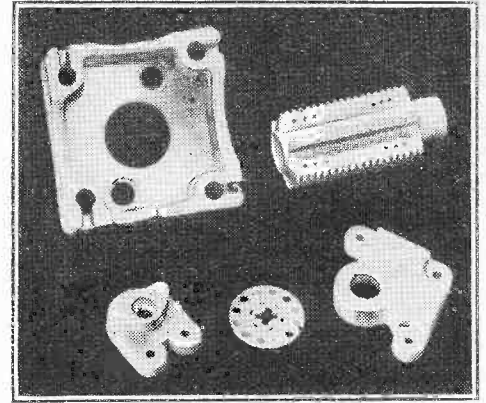

Selection of low-loss Frequentite mouldings shown by Steatite and Porcelain Products.

examples of a similar pattern are among the products of Polar-N.S.F.

The very large number of parts that now has to be accommodated on the chassis of a modern set, quite apart from television sets, has led to a demand for components of extremely small dimensions. One need only examine any of the chassis exhibited to realise this fact. Yet despite this, the quality has to be maintained.

The Drilitic condensers made by Dubilier are largely the outcome of this demand, as they are approximately only

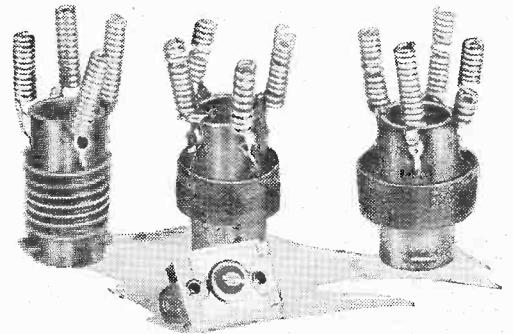

New unit coils with trimmer made by Bulgin.

one-quarter the size of a condenser of equivalent capacity produced a year or so ago. In a metal container measuring 1½in. diameter, T.C.C. has now fitted three separate wet electrolytic condensers, whereas last year this size case held only two. Capacities made are 8-8-8, 8-10-8 and 8-10-4 mfd.

The introduction of the all-wave receiver possibly had a greater effect than any other single factor on the development of high-frequency insulating materials, though the need for low-loss insulators had long been voiced by short-wave amateur experimenters in this country.

As a result rapid strides have been made

Show Review—

in the production of moulded parts for condensers, valve bases, valveholders, coil supports, switches and formers of every



Varley dry accumulator.

conceivable kind. The display of these parts made from Frequentite and shown by Steatite and Porcelain Products well exemplifies the progress made in this field. Many of the new short- and ultra-short wave components, such as, for example, the range of variable condensers shown by Polar, are assembled on Frequentite bases.

Coils of the skeleton type for use in home-constructed sets have been given due attention by component makers, particularly by Bulgin, who this year show a

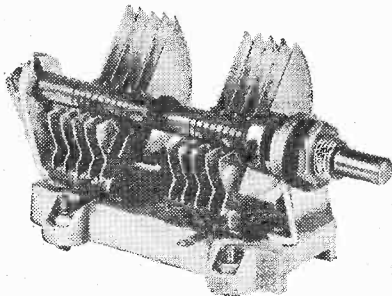

Type E Polar ultra-short wave split-stator condenser mounted on Frequentite.

new range covering all wavelengths from about 7 to 2,600 metres. This firm has introduced numerous new lines, extended some of their existing series, and improved others. For example, a complete new range of HT vibrators for working voltages of from two to thirty-two can now be obtained. Likewise Belling and Lee have devoted much time and thought to the development of new parts, as their series of insulated connectors, particularly for use in television sets and high-voltage circuits, testifies.

Two interesting contributions have been made by makers of batteries for portable sets. One is an extension of the range of dry-cell LT batteries for the latest 1.4-volt valves, and the other is a dry accumulator introduced by Varley.

Basically, the new Varley accumulator is the same as the familiar free-acid lead cell and its potential is two volts, but each cell is solid and contains no liquid electrolyte at all. Possessing the cleanliness of a dry cell, it has the added advantage that the cell can be re-

charged in exactly the same way as an ordinary free-acid accumulator. These new cells are made in a wide range of sizes up to 80 Amp. Hours capacity.

Loud-speaker developments, with one exception, are not apparent to the eye, but if the ear can be relied upon under the rather noisy conditions inseparable from an exhibition, the general quality of the units now being installed in sets is much better than during the last two or three years. The Goodmans "Infinite Baffle" unit is both aurally and visually an improvement on the experimental model shown last August. While retaining the wide frequency response of the original the suspension has been completely redesigned

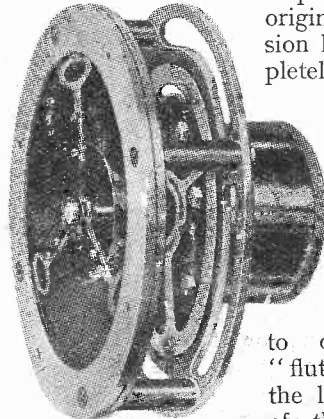

A large diameter rear centring spider is used in conjunction with a three-point radial support instead of the tapes which were employed in the earlier model.

As with the loud speakers, improvements in PA equipment are not readily discernible to the eye, but the ear will be able to differentiate between this and last year's models. Better quality of reproduction, coupled with the use of higher grade microphones, constitute the main line of development. E.M.I. Service has a long range of fixed and portable models containing many improved features, whilst an entirely new range of Truvoice units has been introduced by Henri Selmer. Carbon, moving-coil and a new design of ribbon microphone

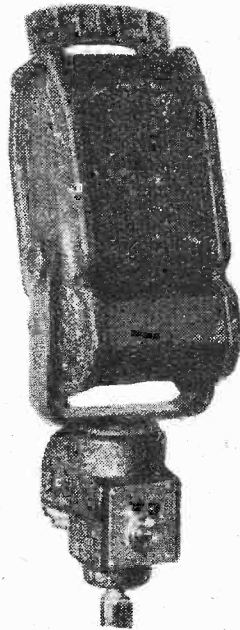

New ribbon-microphone embodying input transformer, made by Henri Selmer.

are included in the latest products of this firm.

Developments in gramophone equipment are chiefly bound up with record-changers and pick-ups. The mechanism of record changing has been taken a step further in simplification and reduction of cost in the Garrard RC10 and RC50 units,

and the shape of things to come is seen in an experimental model of a new record-turning unit (RC100) which plays both sides of ten discs.

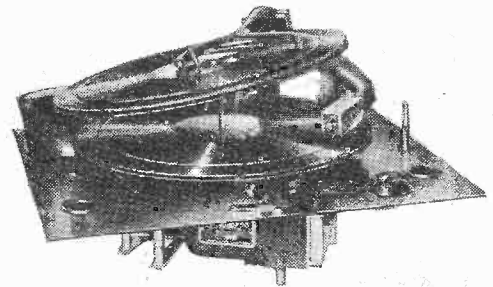

In the Garrard RC50 record changer the selector mechanism has been further simplified.

Most of the progress in pick-up design is epitomised in the exhibit of R. A. Rothermel, Ltd., who are showing piezo electric pick-up cartridges in various stages of manufacture. The torsion type is coming into favour, and a very neat housing has been arranged for it in the new Rothermel "Junior" pick-up.

Apart from the seasonal improvements made in servicing and testing equipment, this year has seen the introduction of several new test sets designed exclusively for adjusting television receivers in the absence of a wireless signal.

The Baird Sync Pulse Generator, which has been produced to enable dealers to install a television set and make all essential adjustments, such as frame and line time-base settings, check for synchronisation and general operation of the set in the purchaser's house without having to wait for

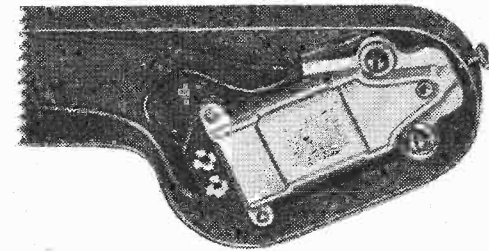

Underside of Rothermel "Junior" pick-up head.

Alexandra Palace to commence transmitting, is quite a small self-contained unit.

An RF output at the correct frequency is provided and this is modulated so that it produces the familiar B.B.C. test cross on the CR tube in the receiver. Alternatively the RF signal can be modulated from an external source so as to give a pattern consisting of vertical bars, these being used to check the overall performance of the receiver.

The user then only has to make a few minor adjustments, such as brilliance and focusing when the transmission starts to ensure obtaining a perfect picture. As the output is adjustable between 200 microvolts and 2 millivolts it allows for satisfactory tests to be made in districts of widely different field strengths. The price complete is £15 15s. od.

Show Review—

Another test set of this kind, but built on much more ambitious lines, can be seen on the Marconi-Ekco stand. Here it takes the form of a large rack-built assembly, being intended for installation in factories and production-test shops. Known as the Scophony Pulse Generator Type OA.134, a video signal, which appears on the CR tube in the set as a lattice pattern of rather complicated design, is produced in addition to the correctly phased synchronisation pulses. The complexity of the pat-

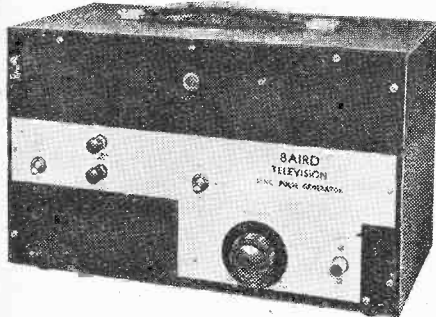

Baird Sync Pulse Generator.

tern enables adjustments to be made for exact focusing and linearity of the time-base circuits. In addition a sound carrier modulated at 400 c/s is produced for checking the sound portion of the set. This test rack can be used with CR tubes or with mechanical scanners.

Full monitoring facilities are included, there being three small CR tubes for checking the waveform at different parts of the equipment and a standard receiver with a large tube for checking the overall performance and comparison with sets under test. It is, in fact, a complete television transmitter, but modulated with a lattice pattern of fixed design for video testing. Both RF frequencies are exact, being generated by crystal controlled oscillators.

The output is applied to a number of buffer amplifiers with an output impedance of 80 ohms and these can be fed to different testing booths by low-impedance transmission lines.

The extent to which cathode ray tubes are now used in general test and servicing work is exemplified by the large number of self-contained units and oscilloscopes

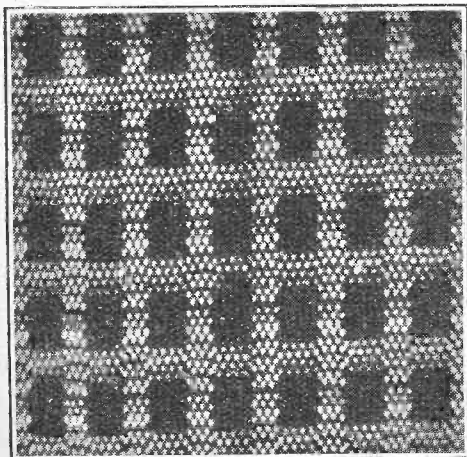

Test pattern produced by Scophony Pulse Generator made by Marconi-Ekco.

shown this year. E.M.I. Service have several models, one of which is a CR tube voltmeter of laboratory pattern, while Cossor has developed a Radio Service Equipment Rack in which is included one of their double-beam CR Oscillographs, Ganging Oscillator, a new Square-Wave Generator and an AC Impedance Bridge. This comprehensive assembly of apparatus enables every kind of test likely to be required by the service engineer, or in a factory test room, to be carried out. Each unit is self-contained and can be supplied separately so that the equipment may be built up in easy stages.

A rack for the two basic units, CR Oscillograph and Ganging Oscillator with switches and input points costs £3, while an extension for the two other units is available at £2 10s. The price of the new Square Wave Generator is £30.

Mullard continue to improve, extend and devise new applications for their CR equipment, the use of oscilloscopes in checking the waveform at different stages in a television set being demonstrated and explained.

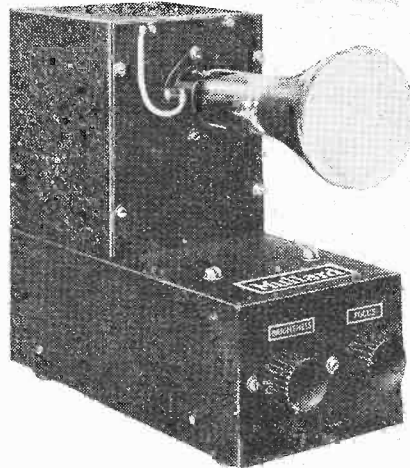

Mullard CR tube model Broo.

An inexpensive self-contained unit comprising a 3-inch hard tube with HT and grid bias supplies and having all high voltage circuits adequately protected, has been introduced this year. The unit, which costs £8 8s., would form the nucleus of a complete oscilloscope, as circuits for time bases and amplifiers are available if required.

The expansion of television reception is exemplified by the large number of firms making a special display of dipoles and other forms of television aerial. Belling and Lee have a comprehensive range, including plain dipoles and reflector types, so also has Antiference, who include twelve different models in the range.

The Belling-Lee Skyrod vertical aerial (for anti-interference broadcast reception) has been improved by making the aerial transformer as an easily replaceable plug-in unit, while the method of installation has been simplified.

E.M.I. Service has developed a new compressed dipole which can be used with or without a reflector, while the new Tilted-wire aerial provides an example of the latest developments made in this field to ensure a good signal in localities where in-

terference is particularly bad, or where one with good direction discriminating properties can be employed to the best advantage.

W. B. STENTORIAN SPEAKERS

New Cabinet Designs for Extension Units

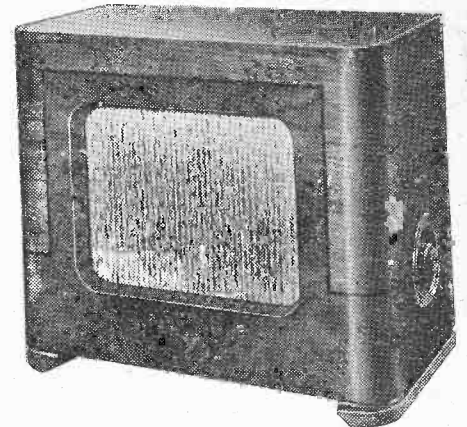

W. B. Stentorian "Senior" cabinet extension loud speaker, Type 40SC.

FOR the coming season the Senior, Junior, Baby and Midget Stentorian loud speakers are being continued without major alteration. A new range of cabinets has, however, been designed and the "Baby" cabinet model is now housed in a horizontal-type cabinet and costs 29s. 6d. complete with volume control.

In the new "Cadet" the constant impedance volume control includes a push-button for use in conjunction with the "Long Arm" remote control device. The cabinet has a plain opening with a thickness of nearly an inch and the corners are rounded. Contrasting veneers are separated by an inlaid dark line.

The "Junior" and "Senior" cabinet models are of similar design and progressively increasing size. The prices are 49s. 6d. and 63s. respectively. Other cabinet models include the "Pendant" model at 59s. 6d., the "Regent" at 5 guineas, and the "Emperor" at 7 guineas.

All the chassis types are available with the Stentorian universal matching device or with direct speech coil connections at slightly lower prices.

Replacement universal output transformers are supplied at a retail price of 5s.

The Wireless Industry

THE 1940 catalogue of the Premier Radio Co., 167, Lower Clapton Road, London, E.5, contains information of many new lines including vibratory power units, mobile amplifiers and an inexpensive cathode-ray oscillograph. It is well illustrated and contains much useful information, including a 20-page valve section. The price, as usual, is 6d. per copy.

The Dubilier Condenser Co. (1925), Ltd., Victoria Road, North Acton, London, W.3, have prepared a new catalogue of condensers and resistances of interest to home constructors and radio and television service engineers. A useful abac for calculating resistance ratings is included.

A trade list of components and accessories has been received from Norman Rose (Electrical), Ltd., 43, Lambs Conduit Street, London, W.C.1. In addition to standard replacement parts the list includes many tools and materials useful to the serviceman.

Garrard Record Changers

The Garrard Engineering and Manufacturing Co. asks us to point out that, in the advertisement in last week's issue, the illustration showed Model RC10, and not Model RC50, as stated.

New Television Aerial

THE TILTED-WIRE SYSTEM, AND HOW IT WORKS

ONE of the most interesting and important developments connected with television aerials has been disclosed by the publication of two recent patents, Nos. 490,414 and 493,758, issued to Messrs. E. C. Cork, J. L. Pawsey, and M. B. Manifold, mem-

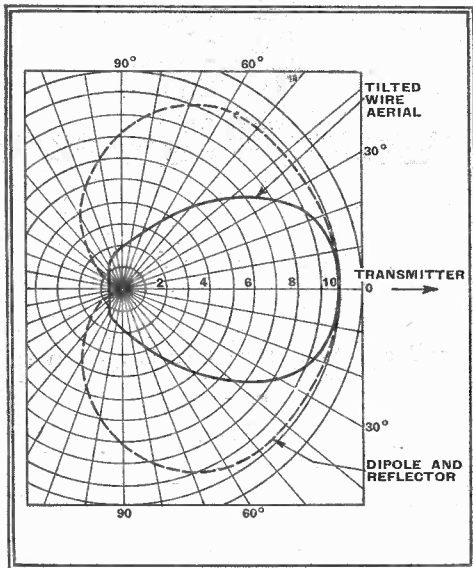

Fig. 1.—The dotted line represents the polar diagram of a dipole with reflector, and shows that at 90 deg. from the direction of the transmitter the pick-up is still 70 per cent. of maximum. The improved directional properties of the tilted-wire aerial are shown by the full line.

bers of the Research Staff of Electric and Musical Industries.

As will be realised from the description which follows, the new type of aerial is almost fundamentally different from the conventional dipole. Since its characteristics, however, are in general considerably superior to a dipole and reflector, and, since it is in any case easier to install, there can be little doubt that its use will soon become widespread.

Anti-Interference Properties

As is well known, a plain vertical dipole aerial is equally sensitive to signals (and interference!) from every direction in the horizontal plane. The use of a single reflecting element behind the aerial is a useful device when the field strength from the transmitter is low or when the receiving aerial is situated in a locality where interference is serious, as it results in a gain of about 3 db. over the single dipole. But, so far as the elimination of interference is concerned, the use of a single element reflector is not of very great value unless the source of the interference is confined to a small angle more or less directly behind the aerial. The reason for this is clearly seen in Fig. 1 (dotted-line curve),

from which it will be seen that the pick-up of the aerial varies almost imperceptibly up to 60-70 deg., and even at 90 deg. from the direction of the transmitter the pick-up is still about 70 per cent. of the maximum.

The polar diagram of the new tilted-wire aerial is shown by a full line in Fig. 1, from which it will be seen that, while its sensitivity to signals from the desired transmitter is of the same order as a dipole and reflector, it is much less sensitive in other directions. This more pronounced directional characteristic is of very considerable assistance in reducing interference from motor car ignition systems, provided always, of course, that the source of interference is not directly between the aerial and the transmitter.

The tilted-wire aerial is a form of wave-antenna of which the well-known Beverage aerial was an early example. Instead, however, of employing an exceedingly long horizontal wire along which the induced waves travelled with substantially the same velocity as the incoming wave from the transmitter, the tilted-wire aerial employs a length of capacity-loaded conductor which forms the effective part of the aerial and along which the phase-velocity of an electric wave is very considerably greater than the velocity of light.

Electrically, the tilted-wire aerial consists of a series of small condensers, as shown in Fig. 2. In practice, such an aerial might consist of, say, No. 14 SWG copper wire cut into short lengths of about 15in., each length being separated from

DESCRIPTION of a recently introduced type of aerial for ultra-short-wave reception that is easier to install and less conspicuous than the conventional type of television dipole. The new tilted-wire aerial is claimed to have marked anti-interference properties.

the next by a small insulator across which a condenser of about 50 micro-microfarads is connected. The phase-velocity of an electric wave along such a path is about 1.4 times the velocity of light.

Process of Phase Addition

Suppose that such an aerial is erected at an angle of about 45 deg. to the horizontal and in the same vertical plane as the waves from the transmitter. As each wave from the transmitter advances past the aerial, it induces corresponding wavelets at each point of the aerial as it passes. These little wavelets travel in both directions, up and down the aerial with, as we have said, a phase velocity of about 1.4 times the velocity of the waves coming from the transmitter. Considering for the moment only the wavelets which travel along the aerial towards the receiver, it will be evident that if the aerial is set

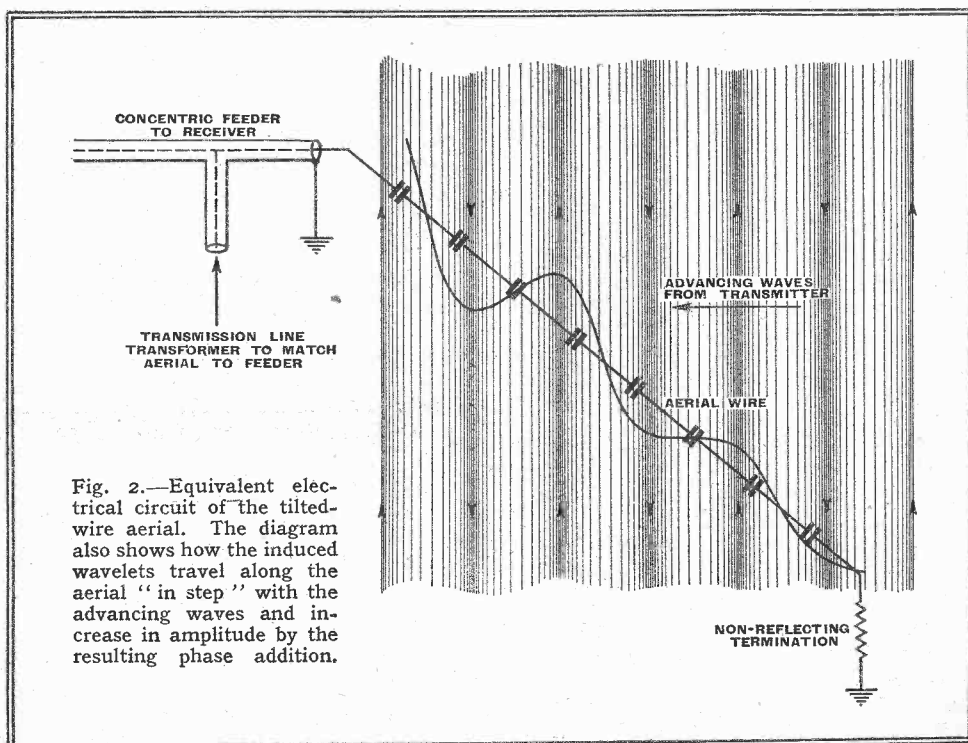

Fig. 2.—Equivalent electrical circuit of the tilted-wire aerial. The diagram also shows how the induced wavelets travel along the aerial "in step" with the advancing waves and increase in amplitude by the resulting phase addition.

New Television Aerial—

up at an angle of about 45 deg., these wavelets will have a component velocity in the horizontal direction which is equal to the velocity of the waves from the transmitter. In other words, a wavelet initiated at any given point travels forward in phase with the wave from the transmitter and, therefore, in phase also with the other little wavelets as they are initiated at each point along the aerial. The wavelets thus augment each other by a process of phase addition, provided, of course, that the vertical plane of the aerial corresponds with the direction of travel of the waves from the transmitter.

If the aerial is not in line with the transmitter, then the wavelets travelling down the aerial will not keep in exact phase with the transmitted waves, and the resulting amplitude will thus be smaller when it reaches the feeder end of the aerial. The aerial thus has maximum sensitivity in one direction only in the horizontal plane provided that it is set up at the correct angle.

It was mentioned above that the wavelets initiated at each point of the aerial by the advancing waves from the transmitter travel in both directions along the

densers, and, although this is the correct electrical equivalent, such an arrangement would have obvious disadvantages in practice.

Instead, the E.M.I. aerial conductor is composed of a twisted pair of wires, alternate wires being cut at intervals of $1\frac{1}{4}$ in., a small gap being left at the point of each cut. The capacity between the overlapping section of the wires provides the requisite amount of capacity loading from which the aerial derives its properties.

The Feeder System

The characteristic impedance of the aerial is of the order of 250 ohms, and, to avoid the losses which would result if this were connected direct to a 70-ohm feeder, a transforming device is required at the junction. It is fairly well known that, in order to match two dissimilar impedances, they may be coupled by a quarter-wavelength line, but if the match is to be an accurate one, it is necessary that the coupling line shall itself have precisely the correct characteristic impedance. It should, in fact, have an impedance equal to the geometric mean of the two impedances which it is to connect.

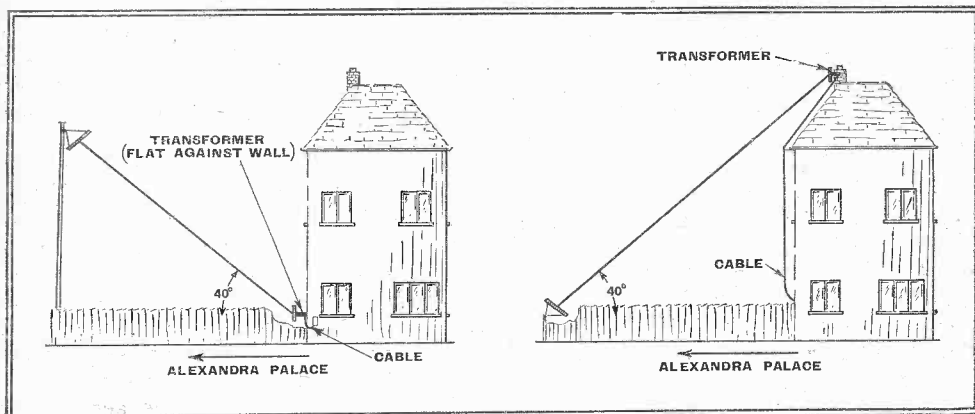

Sketches showing two of the methods in which the new aerial may be installed.

aerial from their point of origin. Since we are only interested in those which travel towards the receiver, it is necessary to arrange for the suppression of those which travel backwards in order to avoid the effects of their reflection which would otherwise occur at the remote end of the aerial. Absorption of the wavelets which travel backwards is achieved by terminating the end of the aerial with a resistance approximately equal in value to the characteristic impedance of the aerial, i.e., about 250 ohms. The other end of this resistance must, of course, be effectively earthed, and this is arranged by connecting the resistance to the mid-point of an ordinary half-wave dipole. Since a dipole possesses a very low impedance to space, it forms the equivalent of an effective earth, but, in order to reduce the general clumsiness and inconvenience of a full-length dipole at the end of the aerial, a "compressed dipole" is employed, this consisting of a coiled winding of appropriate dimensions on a small spreader only about 3ft. in length.

It has been said that the new aerial might be made up of a series of small con-

As lines of only certain impedances are readily available, a correct match might be difficult to obtain, but the desired result is obtained by artificially loading the last quarter-wavelength of the feeder. An impedance, which actually consists of a short-circuited length of feeder, is shunted across the line about an eighth wavelength from its end, and it is possible by correctly choosing the dimensions of the arrangement to obtain an accurate match



Part-sectioned length of the aerial wire, showing the twisted and overlapping conductors with one of the "breaks," which occur at $1\frac{1}{4}$ in. intervals.

between the aerial and the feeder. (Patent No. 489,704.)

As may be seen from the accompanying photograph, this "transformer," or impedance-matching device, is mounted on a small wood panel. This panel also carries a second compressed dipole which

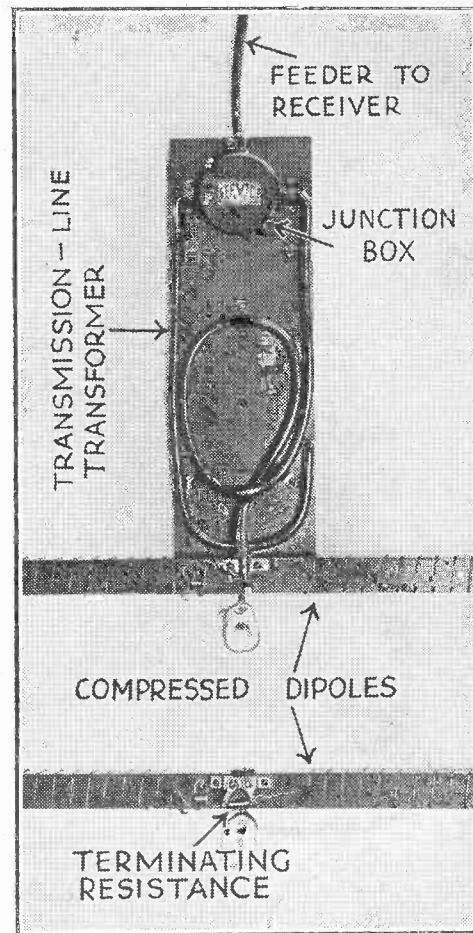

Part of the terminating dipoles; the top photograph shows the connection and transmission-line transformer between the aerial conductor and the feeder.

acts as a virtual earth at the end of the outer conductor of the concentric feeder.

Practical tests with the new type of aerial have shown it to possess almost ideal characteristics for television reception, and the results which one would expect from a review of its theoretical workings are amply borne out in practice. In one particular locality, about twenty miles from Alexandra Palace, where motor car interference had rendered reception, if not impossible, at least very unpleasant at times, and where the addition of a reflector to the aerial had only effected a partial cure, the installation of a tilted-wire aerial has eliminated the interference altogether. While such a complete cure cannot be expected in every case, since a great deal must depend on the exact location of the

aerial, yet its excellent characteristics and general adaptability should enable a very considerable improvement to be made in every case where interference is serious. These factors, combined with its ease of installation and inconspicuous appearance, seem likely to assure its widespread use.

Radiolympiana

By FREE GRID

NO doubt the great majority of you who have visited the Show will have been grievously disappointed at not seeing exhibited a pram equipped with my baby car radio in accordance with my promise of last week; in fact, I am told that on one evening of the Show a hostile demonstration was staged by disappointed readers in front of *The Wireless World* stand, and that the Editor, who happened to be present, only avoided being lynched by escaping in the uniform of one of the commissionaires. The whole trouble is the radio manufacturers. As I told you last week, they were trampling each other under foot in their eagerness to secure the manufacturing rights from me. Unfortunately, however, their idea of fair and equitable terms is not mine, and we were soon compelled to part brass-rags, with the result that not only have I been refused permission to exhibit my Radiopram, but the relations existing between the manufacturers and myself are if possible a little more strained than they were prior to this unfortunate incident.

There was, I am sorry to say, yet another regrettable incident which led to a clash between myself and the authorities. It so happens that I am learning to use one of the new electric razors, and, as the makers of these devices frankly admit, it does take a little time before the schoolgirl complexion stage is reached. At present I am still in the phase where it is necessary to shave twice a day in order to make myself presentable, and in the first few days of the exhibition I was in rather a dilemma, as in the afternoons my face began to look as if it needed weeding rather badly, and as I had several important people to meet every evening something simply *had* to be done about it.

In the end I got in touch with the Editor and secured his permission to have a tea-time shave in the little office at the back of *The Wireless World* stand. One would have thought that no untoward incident could possibly have arisen from such a

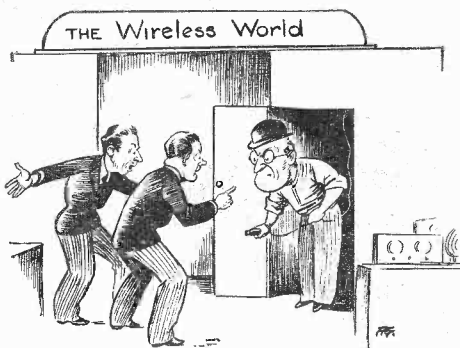

"Vulgar abuse"

simple circumstance as that. I was screened from public view, and visitors were warned off by the simple expedient of hanging a "Danger—High Voltage" notice on the door. There was, however,

one very important fact that I had overlooked, and that was that closed-circuit television demonstrations were going on in Olympia practically throughout the day. Apparently my tonsorial efforts were getting through and playing havoc with the picture at one or two neighbouring stands, in spite of the fact that, as already mentioned, a closed circuit was being used. I am always willing to be helpful, and volunteered to submit my razor to the expert attentions of any firm of "suppressor" manufacturers in the Show whom they cared to bring along. All I met with, however, was vulgar abuse and a complaint to the exhibition authorities, with the result that I and my son Henry, who was with me, were summarily thrown out into the street, and had we not happened to have had season tickets we should have had to have paid to get in again. As we had been ejected once before we were viewed with the codfish

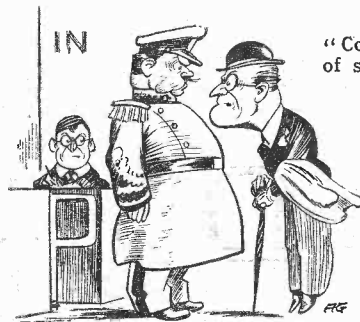

"Codfish eye of suspicion."

eye of suspicion by the Admirals-of-the-Fleet on duty at the door and were only readmitted after a somewhat acrimonious altercation and after being compelled to submit to the indignity of signing our tickets and leaving our fingerprints.

As for the Show itself, I must grudgingly admit that the manufacturers have done us much better this year. I have, in past years, always regretted the presence of the side-shows on the ground that they were non-technical, and I was relieved to see that they were not present last year. This year they have come back with a vengeance, but with the difference that they are of considerable technical interest.

There is not much that I can say about the sets on view, for they are dealt with in other and less widely read parts of the journal, to which I would direct your attention. I did notice, however, that a great number of the receivers incorporated inventions and ideas of my own which I have put forward from time to time in this journal—and this, mark you, without so much as a thankyou, let alone a more tangible acknowledgment in the form of a royalty. Still, such is the fate of all inventors and pioneers, and I well remem-

ber in my younger days going to the theatre with a girl who, throughout the performance, kept her eyes glued to her opera glasses. I felt compelled to remind her of the great debt she owed to Galileo, only to receive the somewhat fatuous answer that she "didn't remember him,"

"The dawn of intelligence."

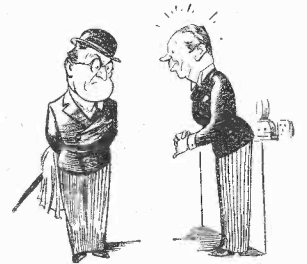

and "what was the name of the film in which he had appeared?"

I should like to pay a tribute to the great improvement made in the matter of having people on the stands capable of giving intelligent answers to a technical question. There is, of course, still a long way to go in this direction, but as I gazed at some of the immaculately clad young men on the stands I was irresistibly reminded of the famous picture by Rembrandt or Beethoven—I forget which—entitled "The Dawn of Intelligence." It is said that the darkest hour usually precedes the dawn, and judging by some of last year's efforts I certainly think that this old saying has once more proved true.

An angry reader has sent me a long telegram—and from Aberdeen, too—rebuking me for flippancy because in my notes last week I said that the side-show in which a demonstration is given of the quality churned out by a modern set and that given by one of a few years back might have been made more interesting if we had also had demonstrated to us the quality of the set of ten years hence. My correspondent suggests that such a demonstration would be a scientific impossibility.

I need scarcely say that it would not be impossible at all. In the first place, I would point out that since a wireless receiver is—or should be—merely a reproducer it would be perfectly easy to demonstrate the perfect reproduction which will presumably be given by a wireless receiver of a century hence. Such a demonstration could be given by putting the actual orchestra into the demonstration theatre; obviously, reproduction would then be 100 per cent. perfect. Now it would be a simple matter to detract from the perfection of this quality, even without calling in the aid of wireless principles, by means of a series of sound-absorbing and sound-reflecting screens.

The only thing lacking now seems to be a means of ascertaining exactly how far short of perfection the set of ten years hence will fall. But the insurance companies' actuaries, knowing the rate of progress since broadcasting began, could surely tell us that?

When you demonstrate your set's reproduction to a friend, are you *sure* it sounds as good to him as it does to you? Or have you developed for your speaker, through long association, an affection which nobody else shares?

How does it compare with a new Stentorian? Take this, if you will, as a friendly challenge, and hear the two speakers side by side. We know you'll be glad if we're right!

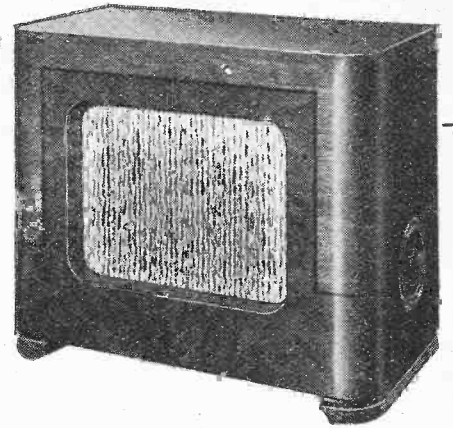

CHASSIS MODELS

Senior	£2 2s. 0d.
Junior	£1 12s. 6d.
Baby	£1 3s. 6d.
Midget	17s. 6d.

CABINET MODELS

Emperor	£7 7s. 0d.
Regent	£5 5s. 0d.
Senior	£3 3s. 0d.
Junior	£2 9s. 6d.
Pendant	£2 9s. 6d.
Cadet	£1 19s. 6d.
Baby	£1 9s. 6d.
<small>(now with volume control)</small>	
Handy "X"	19s. 6d.
Planoflex	£5 5s. 0d.

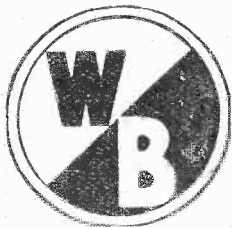

Stentorian
UNIVERSAL PRINCIPAL & EXTENSION SPEAKERS

WHITELEY ELECTRICAL RADIO CO. LTD., MANSFIELD, NOTTS.

GARRARD RECORD CHANGERS
RADIO-GRAM UNITS
MOTORS—SPRING & ELECTRIC

Convincing proof of their popularity is the world-wide demand for "GARRARD" equipment. Specialists in the design and manufacture of Record Changers... Radio-Gram. Units...Motors and Pick-ups...which have stood the test of time.

REMARKABLE NEW MODELS

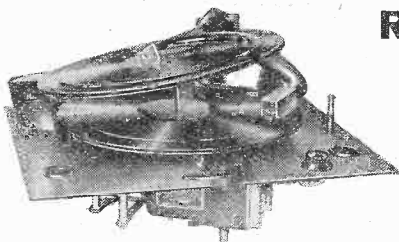

MIXED RECORD CHANGERS. An outstanding design, robust and reliable. Automatically selecting and playing 10in. and 12in. records in any combination.

R.C. 50—AC Model for 100/130—200/250 volts 50/60 cycles **£8.0.0**

R.C. 51—AC/DC Model for 100/130—200/250 volts DC and AC 25/60 cycles.... **£9.5.0**

POPULAR RECORD CHANGERS. A triumph of simplicity and ingenuity. The product of ceaseless research and experiment. A popular priced model, yet maintaining that high "GARRARD" standard—soundness of design and construction.

R.C. 10—AC Model for 100/130—200/250 volts 50/60 cycles **£6.0.0**

R.C. 11—AC/DC Model for 100/130—200/250 volts DC and AC 25/60 cycles **£7.5.0**

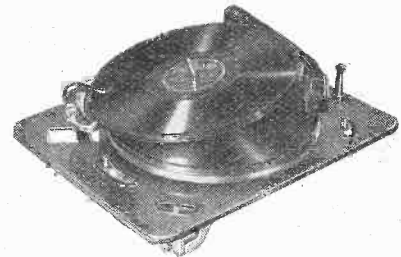

"GARRARD" craftsmanship and precision engineering are reflected in every "GARRARD" Record Changer, Radio-Gram. Unit and Motor.

STAND No. 56—RADIOLYMPIA

THE GARRARD ENGINEERING & MANUFACTURING CO. LTD.
SWINDON WILTS. ENGLAND

Mention of "The Wireless World," when writing to advertisers, will ensure prompt attention.

EVERYWHERE — EVERY TIME — EVERY RESISTANCE

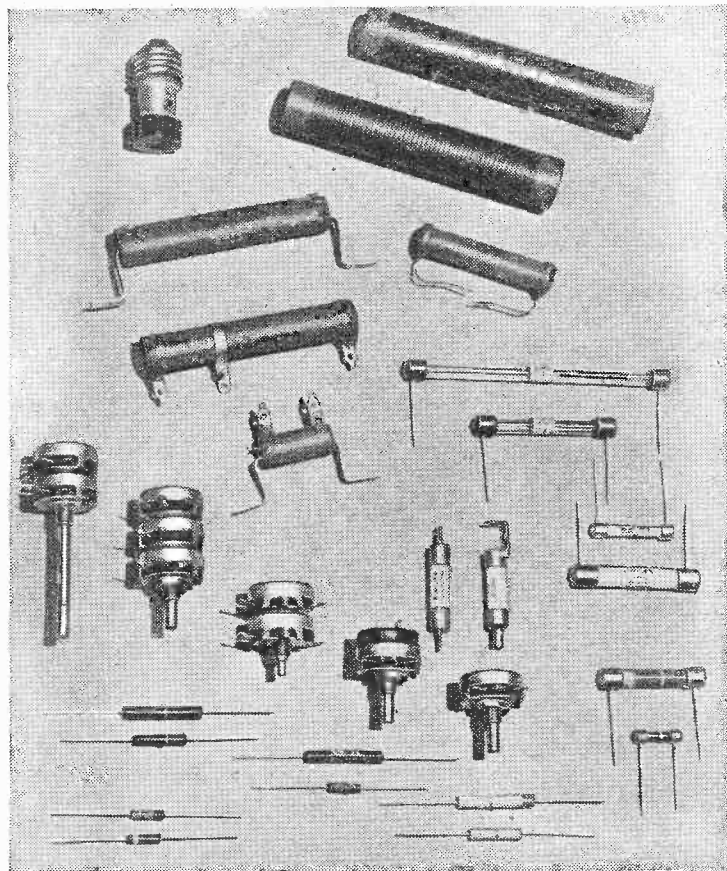

If there's something you want to know about resistances, perhaps we can help you. If there's nothing you don't know about them, you can certainly help us—because we're learning new things every day. In any case, we shall be very pleased to see you at Stand No. 28.

STAND 28
GRAND HALL

Metallised Volume Controls * Insulated Wire Wound Resistances
Motor Radio Interference Suppressors * High-Frequency Power Resistances
Power Wire Wound Resistances * High Voltage Resistances * Ultra
High Range Metallised Resistances * Metallised Resistances

DUBILIER

DUBILIER CONDENSER CO. (1925) LTD., DUCON WORKS, VICTORIA ROAD, NORTH ACTON, LONDON, W.3.

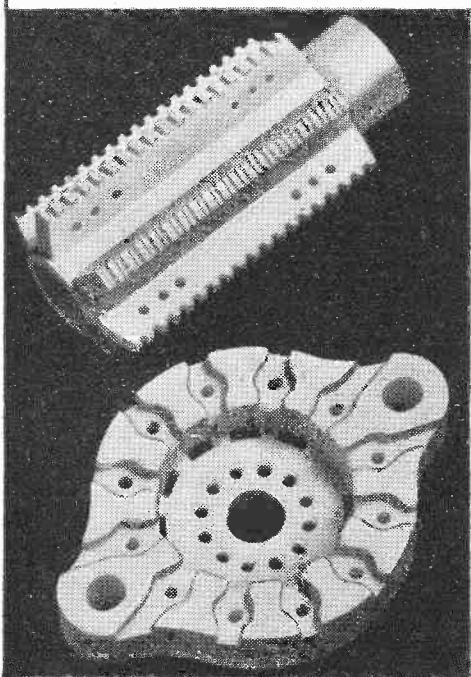

ALL-BRITISH

**LOW-LOSS
CERAMICS**

OF HIGH STABILITY AND MECHANICAL STRENGTH

FREQUENTITE (LOW POWER FACTOR)

NEW FREQUENTITE "S" (ULTRA-LOW POWER FACTOR)

FARADEx (HIGH PERMITTIVITY)

**OLYMPIA
STAND
61**

Ask for new illustrated catalogue S.P.10

STEATITE & PORCELAIN PRODUCTS LTD.
STOURPORT-ON-SEVERN, WORCS.

LONDON OFFICE: THAMES
HOUSE, MILLBANK, S.W.1

Telephone: Stourport 111. Telegrams: Steatoin, Stourport.

AGENTS: J. STONE & CO., CALCUTTA. ASSOCIATED ENGINEERING & CABLES PTY. LTD., MELBOURNE. ALLIANCE ELECTRICAL CO., WELLINGTON, N.Z.
BLANE & CO. LTD., JOHANNESBURG. JOHNSON & FLETCHER LTD. BULAWAYO, & Offices of Imperial Chemical Industries Ltd. throughout the world.

Mention of "The Wireless World," when writing to advertisers, will ensure prompt attention.

“Effective Height”

WHAT IT MEANS AS APPLIED TO RECEIVING AERIALS

By F. R. W. STRAFFORD
(Research Dept., Belling and Lee, Ltd.)

THE term “effective height” is about as applicable to modern radio as the extinct coherer detector. In the early days when nothing but inverted “L” or “T” aerials were employed, and the polarisation of the transmitted and received waves was substantially vertical, the term was applicable in an empirical sense and served as a basis for comparison between the effectiveness of an aerial under prac-

THE author suggests that the expression “effective height,” as applied to receiving aerials, tends to become meaningless. It is a quality depending not purely upon the aerial itself, but also upon the input impedance of the associated receiver.

fully to this simple aerial arrangement which is commonly applied on short and ultra-short wavelengths.

In the case of the dipole the earth is not used as one connecting terminal and may be considered as non-existent. In the conventional “Marconi” aerial, whether inverted “L” or “T,” the earth plays an important part in providing the other input connection.

Consider a vertical wire of height h as depicted in Fig. 2 (a), and further let us assume that we wish to calculate the open circuit voltage e across the terminals A and B. From a high-frequency viewpoint A and B are not open-circuited, because the capacity of the aerial to earth acts across them and offers a finite impedance which decreases as the wavelength to be received diminishes.

Aerial as a Generator

Now the equivalent circuit of Fig. 2 (a), as shown in Fig. 2 (b), is clearly that of a generator whose EMF is Eh , which is driving current through two capacities C_1 and C_2 in series.

This equivalent circuit is only correct if one neglects both the inductance and the resistance of the aerial wire. It may be shown theoretically that this is permissible if the length of wire is not greater than one-tenth of the wavelength to be received. Hence, from 200-2,000 metres; a wire of 20 metres height may be represented fairly accurately by the equivalent circuit of Fig. 2 (b). It may also be shown theoretically that C_1 is very nearly equal to C_2 , so that the voltage e across

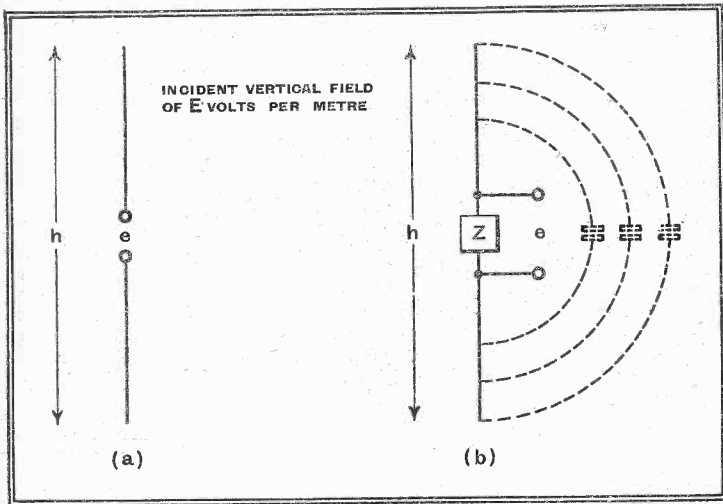

Fig. 1.—A simple dipole (diagram (a)). At (b) is shown the same arrangement with the addition of an impedance load.

tical conditions and the same aerial under theoretically ideal conditions. Furthermore, in the early days, the input impedance of receivers was much higher than that used to-day, and this also contributed to the usefulness of the term in a manner to be hereinafter described in more detail.

Calculating Induced EMF

If a vertical wire is suspended high above the earth's surface (see Fig. 1 (a)) and is acted upon by a vertically polarised electromagnetic wave of field strength E volts per metre an EMF is induced in it whose magnitude is given by the simple process of multiplying the field strength by the height h of the aerial in metres. By height is meant the actual length of the wire and not the actual height above the earth's surface—another important point in connection with the term. Hence the EMF is given by the simple equation $e = Eh$. It must be remembered, however, that this simple formula is only applicable when the length of the aerial is quite small compared with one quarter of the wavelength of the electromagnetic field to which the aerial is responding.

It is obvious that one cannot use this voltage so created without some loss occurring, since the aerial is not a closed

which is not actuated by current (e.g., an electrometer).

If, as in Fig. 1 (b), we connect an impedance Z (which might be the input of a broadcast receiver) in the manner shown, the PD across its terminals can never be as great as the EMF induced in the aerial.

The PD is produced as a result of the EMF giving rise to currents around an infinite number of capacities as indicated by the dotted line which represents a few representative paths. Hence the amount of current which flows and thereby creates a PD across Z is a function of the geometry of the wire. Figs. 1 (a) and 1 (b) are typical of what is known as the dipole aerial. If the length of the wire on each side of the impedance Z is any integral multiple of a quarter of the working wavelength, the aerial is referred to as a tuned dipole. It will later be considered whether the term “effective height” can be applied use-

circuit of zero impedance. It is not the aerial EMF which operates our radio receivers but the PD produced across its input impedance by currents caused to flow round a circuit by the action of an applied EMF. The term EMF and PD are often loosely used, and the reader should remember that EMF may only be measured directly by an instrument

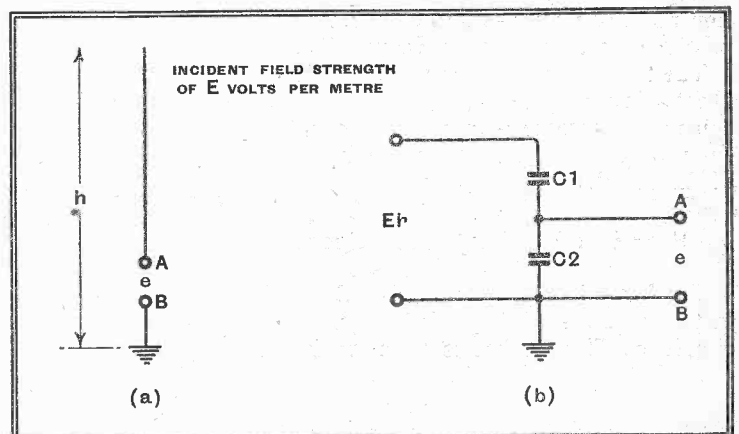

Fig. 2.—Diagram (a) represents a simple “Marconi” aerial, while at (b) is shown the equivalent circuit.

A and B must be half the generated EMF since it is equally divided between the two capacities. Hence e is equal to Eh divided by 2.

We now approach closely to a correct

“Effective Height”—

appreciation of the term “effective height.” The aerial generates an EMF equal to Eh , but we can only use half of this under the ideal open circuit conditions. Hence the PD we obtain is the same as the EMF generated in an aerial of half the height. Hence we say that the effective height of the aerial is half its physical height.

Thus we may define “effective height” as that height he which will provide an EMF equal in magnitude to the PD we

see that the effective height of an aerial is a quantity which is not purely characteristic of the aerial itself but depends upon the input impedance of the receiver to which it is connected.

A further influencing factor is that provided by any departure from uniform distribution and vertical polarisation of the actuating electromagnetic field. The proximity of other conducting objects, such as buildings and trees, will modify the distribution of the field along the vertical portion of the aerial.

Hence the generated EMF will not be given by Eh excepting under ideal theoretical conditions—that is a flat, perfectly conducting earth, and an entire absence of nearby vertically disposed conductors.

The effect of this modified field distribution is to provide a further reduction in the PD across the receiver input impedance and can only be referred to in terms of the present definition of the expression “effective

Note here that the term “height” only applies to the length of the wire and is not relative to the position of the earth with respect to the wire—another stumbling block in the lay interpretation of the term “effective height.”

The same influencing factors apply with the exception of (1) since there is no horizontal roof. If the dipole is tuned so that the total length of wire is equal to $\frac{\lambda}{2}$ where λ is the working wavelength, it can be shown that the effective open-circuit height is given by the expression $he = \frac{\lambda}{\pi}$. When

the dipole is matched to its resistive load (theoretically 72 ohms: practically, something like 90 ohms), the effective height becomes $he = \frac{\lambda}{2\pi}$.

Proof of these formulæ involves the analysis of hyperbolic function and is somewhat beyond the scope of this article. It can be readily appreciated, however, that the term “effective height” is applicable in a purely classical sense to the tuned dipole and is useless for practical design purposes.

Finally, there is the frame or loop aerial. The open-circuit voltage in this case depends upon various dimensional factors of the loop and also the wavelength to be employed. Providing the dimensions of the loop are small compared with one quarter of the working wavelength and the number of turns are small the formula for the open circuit voltage e is given as follows:—

$$e = \frac{2\pi Ehb n}{\lambda}$$

- When h = height of loop.
- b = width of loop.
- n = number of turns.

If we equate this in terms of our expression $e = \frac{Eh}{2}$ for the open-circuit volt-

age from a vertical aerial and solve for the effective height he of a loop in terms of an open aerial we find that $he = \frac{2\pi hbn}{\lambda}$

which is equal to the physical height multiplied by $\frac{2\pi bn}{\lambda}$ and has nothing whatever

to do with the height of the loop above ground, and is only proportional, with other factors, to the height of the loop. Here again the same factors (2) and (3) as for the vertical aerial influence the ultimate value of he .

Apart, therefore, from the particular case of the simple vertical aerial working into a fairly high impedance, the term “effective height” appears to be completely devoid of practical usefulness. This is made all the more obvious when one considers the modern receiver with its comparatively low input impedance and the increasing tendency towards screening of aerials, resulting in non-uniform field distribution. The author therefore proposes that the term should be relegated to the limbo of forgotten things, as something that has outworn its usefulness. He ventures to predict that it will not be used in two or three years’ time

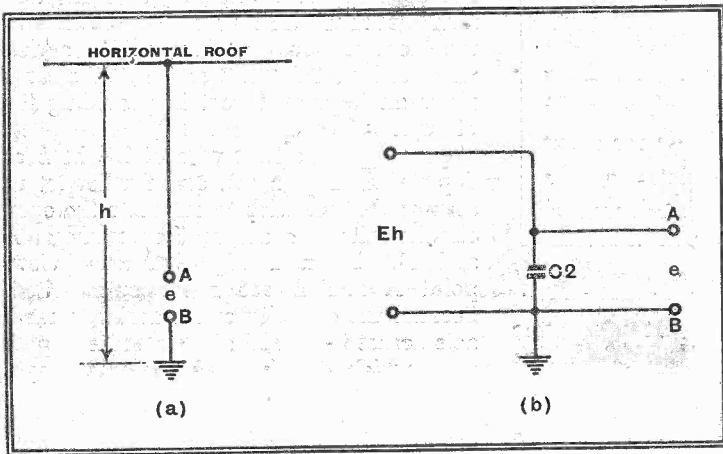

Fig. 3.—A “Marconi” aerial with a horizontal roof. Subject to restrictions mentioned in the text, diagram (b) represents the equivalent circuit when the roof is infinitely large.

obtain from an aerial of height h . Obviously he must always be less than h .

Now let us increase the capacity of C_1 by adding a horizontal roof to the aerial as shown in Fig. 3 (a). If this roof could be increased indefinitely C_1 would become so large compared with C_2 that the equivalent circuit could be redrawn as in Fig. 3 (b) and in this case $e = Eh$ and the effective he , becomes equal to the physical height h of the aerial. In practice, however, the roof cannot be increased without restriction since it must be remembered that as soon as the total aerial dimensions approach one quarter of the working wavelength the simple capacity consideration no longer applies and classical transmission line theories must be applied.

The adding of a roof to a vertical aerial always increases the effective height but can never increase it to a height equal to the physical length of the vertical portion of the aerial.

Practical Working Conditions

The foregoing has been discussed purely in terms of what is regarded as the open circuit condition, that is with no impedance between the terminals A and B other than that offered by the aerial capacity itself.

When a broadcast receiver is connected between the terminals A and B it is clear that the PD across these points must be reduced to a lower value than $\frac{Eh}{2}$ and the equivalent circuit now becomes that shown in Fig. 4. Hence the effective height is by definition similarly reduced. Thus we

height,” as a reduction thereof.

Summarising: the derived expression “effective height” is only applicable where the aerial has dimension small compared with one quarter of the working wavelength, and it further depends upon:—

- (1) The amount of roof capacity of the aerial.
- (2) The input impedance of the receiver.
- (3) The configuration of the electromagnetic field.

It is impossible to derive the separate contribution of (1), (2) and (3) without experiments, so that if one is given the effective height of an aerial associated with a receiver it is impossible to say to

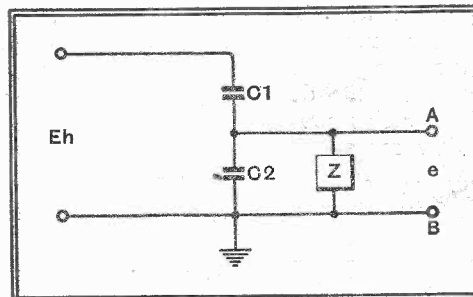

Fig. 4.—Equivalent circuit of a “Marconi” aerial with an input impedance connected between the lead-in wire and earth.

what extent the figure is dependent upon the various parameters described.

In the case of the dipole of Fig. 1, it can be shown that the same reasoning applies, and that the effective height is given as $\frac{Eh}{2}$ under the open-circuit conditions.

Sideshow at Olympia

THE NON-COMMERCIAL EXHIBITS

THE annual Radio Exhibition has always been noteworthy for the fact that there are several interesting things to see apart from the sets and the components on the stands of the manufacturers, but there has never before been such a variety of these sideshows as this year. The B.B.C. is, as usual, the principal showman, and the theatre, with its opportunity of seeing broadcasting stars in the flesh, is the principal B.B.C. show for the ordinary listener. Apart from this, however, the B.B.C. is making a special effort this year to claim the attention of those visitors to the show who like to see something of the technical side of broadcasting.

The main technical exhibit of the B.B.C. is in the small National Hall, and the visitor is able to inspect many objects of interest, including the mobile film and sound-recording units and the "fire escape" portable television aerial used for relaying certain television O.B.s to the Alexandra Palace. Another exhibit of considerable technical interest on this stand is the van containing the apparatus for measuring field strength in different localities. This enables B.B.C. engineers to check up on any transmitter in an area where signal strength is reported to be in any way abnormal.

Televiewers will be particularly interested in the repeater station, which is used in conjunction with ordinary G.P.O. telephone circuits for conveying O.B. signals to the

present used by the B.B.C. is also shown.

The model wireless factory in the main annexe of the main hall is by a long way the largest single sideshow of the Exhibition. In it are to be seen working machines to be found in receiver and component factories. Most of the leading manufacturers are represented, and the visitor can see the

One of the camouflaged mobile stations shown by the Royal Corps of Signals.

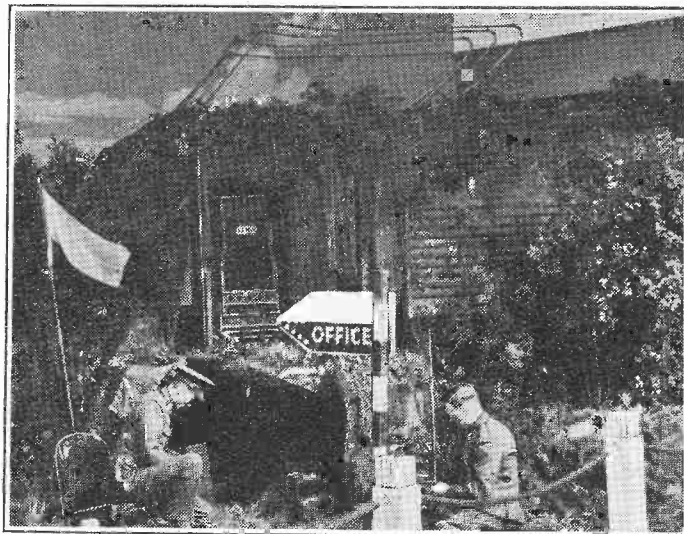

whole process of set making from the manufacture of the wire to the wiring up of the complete receiver. All the intermediate processes, such as coil making and testing and the manufacture of valves, batteries, and transformers, are also exhibited, while in the centre of the factory is a large revolving drum carrying receiver chassis in various stages of manufacture.

Of even greater interest than the manufacture of receivers and components are the methods taken to test them, and among

other things the visitor is enabled to see how condensers are individually tested and then how, after becoming part of a receiver, they are ganged and aligned. The wobulator used for testing the response curve of television receivers attracts considerable attention. It consists of an oscillator, the frequency of which is varied between 41 and 49 Mc/s about 300 times per second. It enables both the gain and the frequency response of the television receiver to be quickly ascertained.

The G.P.O. has considerably widened the scope of its exhibit this year,

and on its stand in the National Hall a good deal of interesting apparatus is to be seen, apart from instruments used for tracking interference, which, as in previous years, are strongly in evidence. One of the most interesting exhibits is a microwave transmitter and receiver in actual operation on a wavelength of 20 centimetres. The visitor is able to rotate the whole transmitter, including the aerial system, and observe the very marked directional effect as transmitted by the

signal strength given out by the neighbouring receiver. Coming up the wavelength scale from 20 centimetres to 4.4 metres, there is exhibited a transmitter-receiver designed for this latter wavelength and used by the G.P.O. for linking up outlying islands off the Scottish coast. Another exhibit of interest is a model coast station as used for working with ships at sea.

The three fighting services are all represented. The Navy exhibit consists of the wireless cabin of a destroyer. On the stand of the Royal Corps of Signals, representing the Army, are a number of cleverly camouflaged mobile wireless stations. These range from a three-ton lorry carrying the complete gear necessary to provide long-range communication between headquarters of Army formations, to an assembly designed to be carried as a pack by one man, the purpose of this latter being to provide communication by wireless telephony between the units of an infantry battalion. On the R.A.F. stand, as would be expected, emphasis is laid on various methods of DF and homing for aircraft. Several types of aircraft radio installations are shown, demonstrating the principles of remote control of tuning as used in R.A.F. machines.

Visitors from overseas should not omit to pay a visit to the export stand, on which are exhibited many sets and components, designed and manufactured specially for use in tropical climates. Complete receivers are exhibited by H.M.V., Marconiphone, Alba, G.E.C., Cossor, and Ekco, while components are shown by Plessey, T.C.C., Reproducers and Amplifiers, Ltd., Garrard, Belling and Lee, Bulgin, Erie, Westinghouse and Carr Fastener. Many of the sets exhibited in this section are fitted with specially designed tuning systems for receiving Daventry at the various Empire stations. All these sets are built to British Standards Specification No. 415, and will pass any local electrical regulations.

No visitor, be he televiewer or not, should omit to pay a visit to Television Avenue in the gallery. It can be said without hesitation that this is by far the best method of demonstrating television that has yet made its appearance in any exhibition.

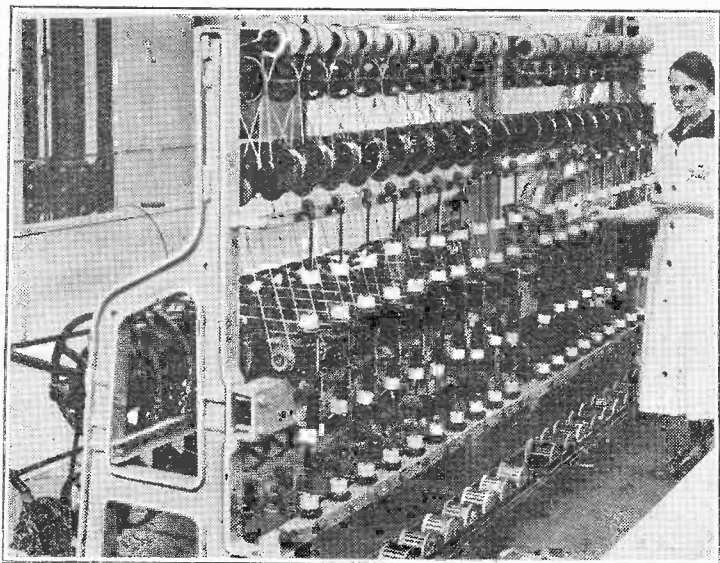

In the Model Factory; the process of lapping 40-SWG copper wire and 30/48 SWG Litz with a double silk covering was demonstrated by the Scott Insulated Wire Company.

nearest point at which specially laid television cables are available. There is also a "sound" O.B. transmitter covering a wave range of 40-120 metres, which is used in cases where a cable is impracticable. Another piece of apparatus of this type is the microwave transmitter, which is carried strapped to the back of the commentator, and is used to enable him to wander freely about among crowds. A collection of various types of microphones which are at

The Wireless World PRE-SET QUALITY RECEIVER

A full description, together with circuit diagrams, photographs, constructional details and notes on

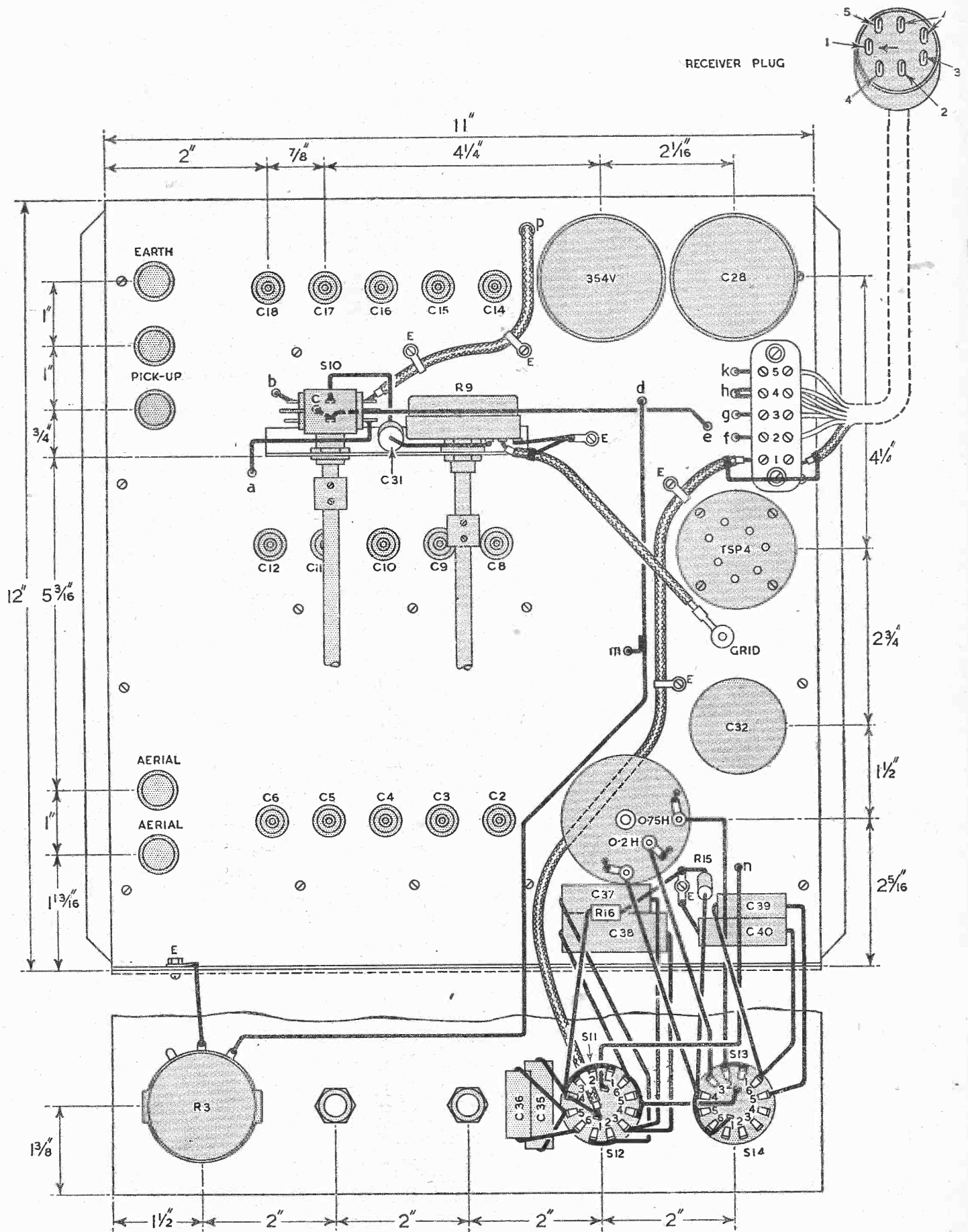

ASSEMBLY AND WIRING DETAILS OF THE RECEIVER UNIT

the adjustment of this receiver and its power unit, was published in our issues dated August 17th and 24th

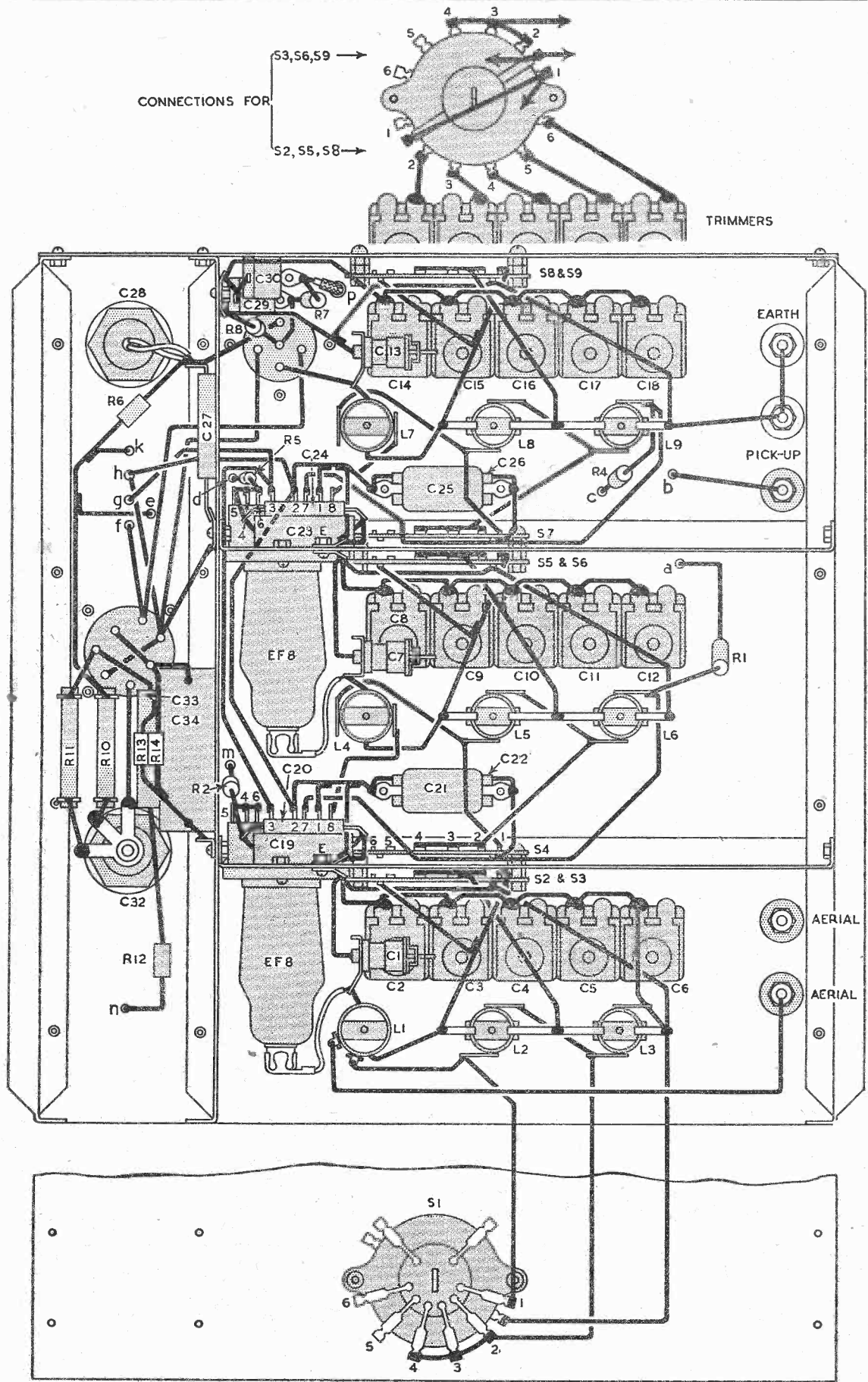

WIRING DIAGRAM OF THE POWER UNIT OF The Wireless World PRE-SET QUALITY RECEIVER

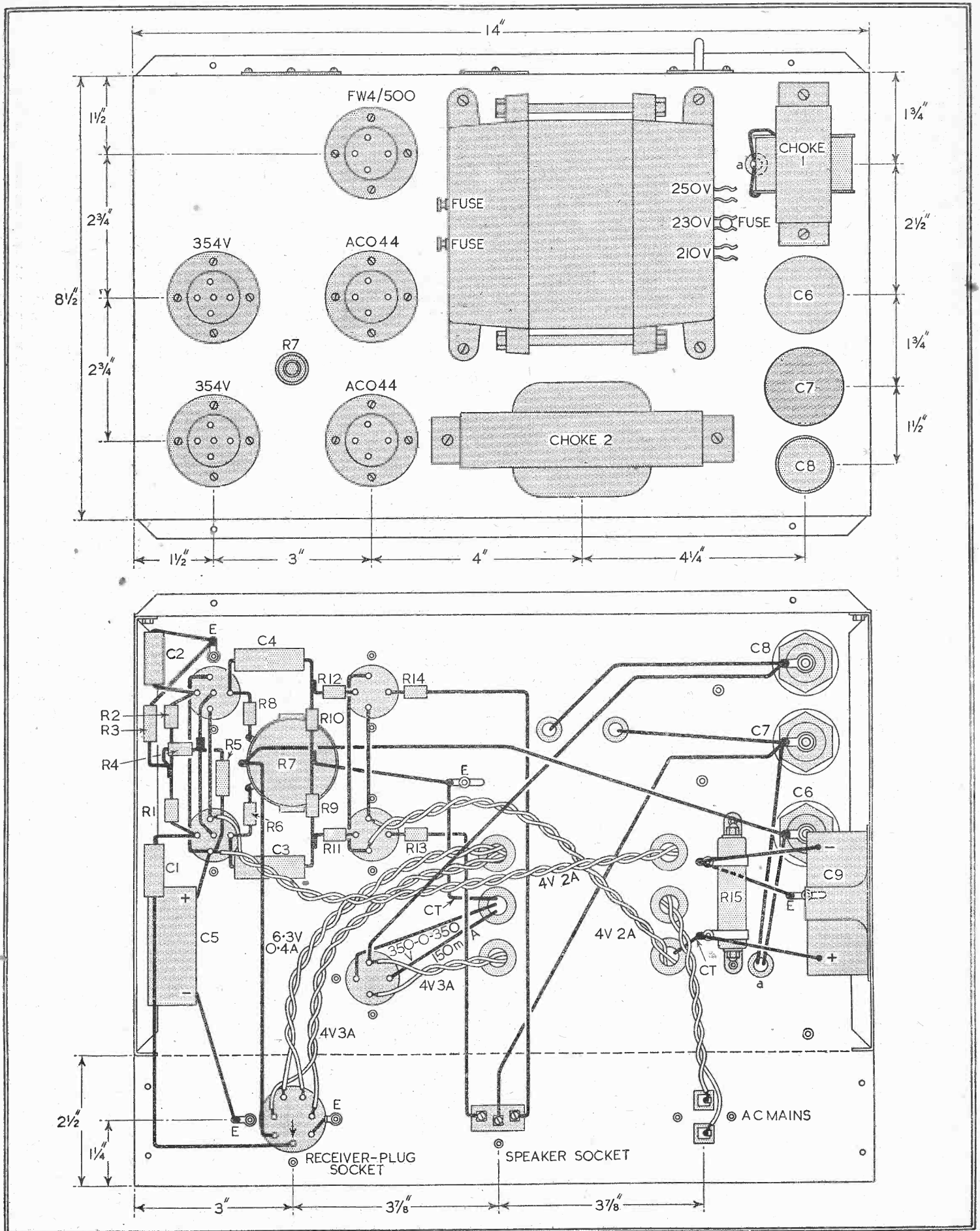

Constant Sharpness of Tuning

STEPS TOWARDS THE IDEAL ALL-WAVE RECEIVER

IT is well known that tuning on short waves is much sharper than on medium, and on medium than on long. This simple fact, observable by anyone possessing an all-wave set, has been responsible for many misconceptions. It is, for instance, often believed that the tuning is sharper at the higher frequencies than at the low because the selectivity is greater. Actually, however, the selectivity is not greater; surprising as it may seem, it is often much lower. Generally, selectivity is at its highest on long waves where the tuning seems the flattest!

This common misconception is brought about by the fact that the sharpness of tuning as it appears to the operator depends not only on the selectivity but on the tuning range. An increase in selectivity is always accompanied by an increase in the sharpness of tuning, but that it is not the only factor is readily demonstrable with a modern all-wave superheterodyne. With such sets selectivity is substantially constant everywhere, and yet the sharpness of tuning increases rapidly on the lower wavelength ranges.

The factor responsible for the apparent sharpness of tuning is the change of frequency for a given movement of the tuning control, or the number of kilocycles covered in 1 deg. rotation of the control.

An ordinary set covers about 550 kc/s to 1,500 kc/s on the medium waveband. This is a frequency ratio of 2.73:1 and a band of 950 kc/s. With the usual 180 deg. rotation of the condenser this represents 5.27 kc/s per degree. This is for a straight-line frequency condenser; with a condenser having a different law the frequency change is greater over part of the scale and less over another part.

On long waves, the coverage is usually about 150 kc/s to 410 kc/s, giving the same frequency ratio, but a band of only 260 kc/s. As a result, the "sharpness of tuning" is only 1.44 kc/s per degree. On short waves the frequency ratio remains about the same, and a typical band might be 6 Mc/s to 16.4 Mc/s (50-18.3 metres). The band is now 10.4 Mc/s = 10,400 kc/s, giving 58

AT short wavelengths the true selectivity of an all-wave set is actually inferior to that at medium and long wavelengths, in spite of the fact that tuning seems to be vastly more critical. This apparent anomaly is explained in the present article, and the possibilities of radically improved tuning systems are discussed.

kc/s per degree for the sharpness factor! The sharpness of tuning is about 11 times as great as on the medium waveband and 40 times as great as on long waves.

As an example of what one might ex-

pect, Table I shows the figures for an all-wave set covering 5-2,000 metres in six bands, assuming a constant frequency ratio of 2.73:1 for every band. On the ultra-short waveband the sharpness of tuning reaches 221 kc/s per degree! With the usual 9 kc/s station spacing, there is room for 24 stations in every degree!

Of course, in practice the same frequency ratio is not maintained on all bands, but in the average case it does not change very much. In an all-wave set it is rarely less than 2:1 on any band. It is largely because of this that few sets tune

kc/s per degree, we shall need 63.5 bands to cover 0.55-61 Mc/s! This is clearly impracticable with present-day tuning systems. Without a radical departure from normal methods the best that can be done is to adopt a compromise, to decrease the frequency ratio on the higher frequency bands and so reduce the sharpness of tuning as compared with the figures in Table I. This inevitably means an increase in the number of bands.

One example of this course is given in Table II. This is taken from an actual receiver which had a small capacity tuning condenser for ranges 6, 7 and 8, and a normal capacity one for the other bands. The minor variations in frequency ratio are caused by the different values of the stray capacities on the different bands. In spite of the increase in the number of bands to eight the sharpness figure is still high.

So far as actual tuning is concerned it is possible to keep it reasonable by the use of a suitable reduction ratio drive. It is customary to use about 6:1 for the ratio on the medium waveband, and referring to Table I, this makes the sharpness about 0.88 kc/s per degree movement of the control knob. On range 5, the reduction ratio needed for the same sharpness would be 86.5/0.88 = 98.5:1. This is well within the bounds of possibility, and it is common practice to employ a ratio of this order.

While it simplifies the tuning, it does nothing to improve the dial itself. The scale length is still inadequate to make it possible to read the dial sufficiently accurately to record settings for particular stations. Various methods of overcoming this have been tried, and among the most promising are systems of optical magnification of the scale, but these are still uncommon.

The use of band-spread is usually no solution of the problem. The auxiliary tuning control makes tuning quite easy, and its scale can easily be read. The calibration, however, depends entirely upon the accuracy with which the main control can be set, and this is no better than with the ordinary arrangement.

TABLE I

Band	Frequency Ratio	Frequency Range Mc/s.	Wavelength Range metres	Frequency Band kc/s.	Sharpness kc/s per degree
1	2.73	0.15—0.41	2,000—732	260	1.44
2	2.73	0.55—1.5	550—200	950	5.27
3	2.73	1.45—3.96	206—75.7	2,510	13.9
4	2.73	3.5—9.55	85.6—31.5	6,050	33.6
5	2.73	9.0—24.6	33.3—12.2	15,600	86.5
6	2.73	23—62.8	13—4.78	39,800	221

TABLE II

Band	Frequency Ratio	Frequency Range Mc/s.	Wavelength Range metres	Frequency Band kc/s.	Sharpness kc/s per degree
1	2.29	0.139—0.318	2,160—945	179	0.995
2	2.73	0.5—1.365	600—220	865	4.8
3	2.83	1.26—3.57	238—84	2,310	12.8
4	2.75	2.75—7.55	109—39.8	4,800	26.6
5	3.0	6.3—18.9	47.6—15.9	12,600	70
6	1.49	18.6—27.8	16.1—10.1	9,200	51
7	1.57	2.38—37.4	12.6—8.05	13,600	75.5
8	1.59	36.6—58.2	8.2—5.15	21,600	120

above some 42 Mc/s and the majority do not go above 24 Mc/s. There are other difficulties, but the tuning problem is one of the greatest.

The ideal is obviously constant sharpness, which means a constant frequency band on all ranges. If we make this the same as on the medium waveband, 5.27

Constant Sharpness of Tuning—

A modification of this idea, however, has distinct possibilities. This is to abandon continuous control by the main dial

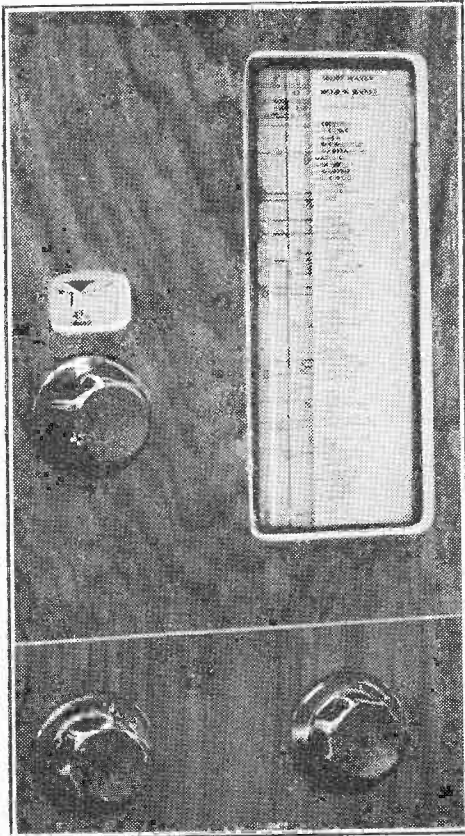

One of the most ingenious methods of overcoming the difficulty of critical tuning on short waves was that introduced in the Murphy A36 receiver. The waveband required is selected by means of the upper left-hand knob (controlling RF stage and 1st frequency changer), final tuning is then effected by varying the 1st intermediate frequency of a double superheterodyne circuit.

and to provide it with a system of mechanical stops which lock it in any one of half a dozen definite positions. All tuning is then carried out on the band-spread dial. In effect, one then has double waveband switching with a single tuning control giving very small coverage. One might, for instance, have four SW ranges on the usual inductance switch control, and six on the stepped condenser control, giving a total of twenty-four effective bands.

This scheme is not yet common, but it is used by at least one firm, who moreover, also obtain constant sharpness of tuning. This is done by using an ordinary medium-wave superheterodyne and preceding it by a SW converter. The converter controls are the usual inductance switching and a variable condenser movable only in definite steps as already described. All tuning is carried out on the medium wave set. This is a clever idea and works well.

Armstrong Chassis

In the Show Report section of our last week's issue the price of the Armstrong Model SS10 was incorrectly given as 10 gns. The price is actually 12 gns. for the all-wave model; the equivalent 2-band broadcast set costs 11 gns.

Five-Metre DX

TRANSMITTING WITH INDOOR AERIAL

IT seems advisable to clarify a statement made in these notes recently regarding the weather conditions encountered on Snowdon by GW6AA. As reported it implies that the unprecedented bad weather coincided with the week-end July 29th-30th, whereas it was the July 9th Field Day that was rendered so unpleasant by the weather.

Despite the fact that many of the regularly heard five-metre stations appear to be quiescent, due no doubt to holidays, activity has been moderately high for the week August 11th to 18th. G2MV has been heard on several occasions reporting reception of French stations, though it is not known if any two-way contacts have actually been effected.

On Monday, August 14th, strong signals were being received in London and the southern counties from G6CW, and between 9 and 10 p.m. GMT this station was heard working G2ZV located near Littlehampton. G5RD at Abbots Langley also effected contact with G6CW, whose telephony was peaking to R9 at times, though very deep fading was observed.

The writer's station is about 14 miles N.W. of London, and in almost direct line between G6CW and G2ZV, yet, while the former was of exceptional strength, the latter's CW signals were barely audible.

CW at fair strength on Wednesday evening with only slight fading.

When the writer remarked on the great difference in signal strength between his (G2OD's) and G2ZV's signals, the information was imparted that the former's station is located at High Salvington on the South Downs just behind Worthing, whereas G2ZV is at sea level. The near presence of the Downs appears to have a greater absorbing effect on the transmitted signals than on the received, as G2ZV reports quite good reception of stations situated to the north of him. G2MC.

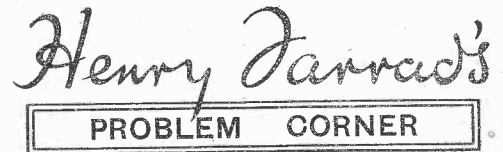

No. 35.—“A Continuous Buzz”

An extract from Henry Farrad's correspondence, published to give readers an opportunity of testing their own powers of deduction:—

67, Muddlecombe Buildings, Nether Backwash.

Dear Mr. Farrad,

I have a 3-valve set—HF, detector and output pentode. When the HT battery is new it is not too bad, but when it is near the end of its life—as now—the volume is poor. So as I had an old intervalve transformer doing nothing I connected it in place of where the grid leak used to be, as in the diagram herewith, with the idea of getting more amplification. But whenever I turn the volume up there is a continuous buzz that gets very loud if I turn it far. It doesn't make much difference whether a station is tuned in or not.

Can you advise me how I can avoid this buzz and yet get good volume?

Yours truly, Ernest Tryer.

What was wrong? Henry Farrad's solution is on page 225.

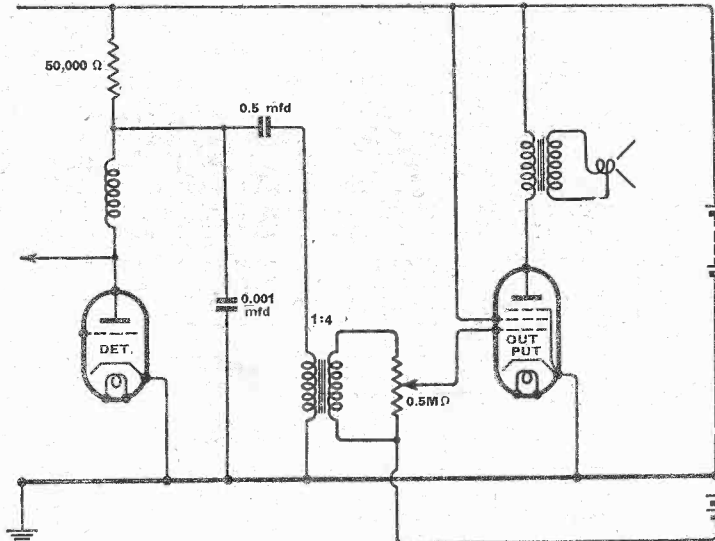

The Nottingham station was apparently receiving G2ZV very well indeed.

On Wednesday evening, at 9.30 GMT, a "test" call brought forth a reply from G2ZV, whose signals at times peaked to R5, but deep fading precluded receiving more than 50 per cent. of the replies.

The strange part about this affair is that G5RD, who is 12 miles north of the writer's station, invariably receives G2ZV at far better strength.

Good conditions prevailed on Thursday evening, August 17th, when surprisingly strong telephony signals were received from G2OD. It transpired that this station is still using a temporary indoor aerial, yet the telephony was received by G6CW in Nottingham at R5. The distance would be about 150 miles.

G2OD reported having heard F8AA on

ATMITE

THE Strowger Journal for May, 1939, a publication of the Automatic Telephone and Electric Co., Ltd., of Strowger Works, Liverpool, 7, contains details of a new material with interesting properties. Atmite is a silicon-carbide compound which has a resistance very nearly inversely proportional to the third power of the applied voltage. It is mechanically tough and is capable of withstanding a crushing strain of 26 tons per sq. in.

In the form of a disc of 1 in. diameter with a thickness of 0.125 in., it has a resistance of over 100,000 ohms at 100 volts, falling to only 600 ohms at 400 volts. The permissible continuous dissipation is 2 watts.

The material has valuable applications for spark quenching, for lightning arrestors, for the suppression of induced EMFs in telephone work, and for the protection of copper-oxide rectifiers.

NEWS OF THE WEEK

TELEVISION DEVELOPMENT

Improvements at A.P.: Extension to the Provinces

SOME interesting points were raised during the Dealers' Television Convention which was held last Thursday, August 24th, at Olympia.

The first speaker was Dr. E. V. Appleton, who was recently appointed to serve on the Television Advisory Committee. He said that he was unable to disclose the recommendations of the Committee to the P.M.G., but he enumerated the points considered. Regarding the London area, he said that the service was stable for some years to come, and that he was frankly disappointed in the response of Londoners to the service.

Sir Stephen Tallents, B.B.C. Director of Public Relations, who was the second speaker, referred briefly to the work of the B.B.C. television staff and the Television Development Sub-committee of the R.M.A. Sir Noel Ashbridge, B.B.C. Director of Engineering, in his address, dwelt at some length on the improvements during the year at Alexandra Palace. These include the new studio, a central control room, improved lighting and considerable development in the Emitron, due to Marconi-E.M.I. research. He referred to the addition of a second O.B. unit; the Highgate receiving post and the portable "fire-escape" aerial. It was now possible, he said, to use the ordinary telephone lines up to distances of four miles for the purpose of linking with the balanced cable. Repeater stations are required at approximately every mile of the P.O. line.

Range of A.P.

Sir Noel was emphatic in his denial that the problem of linking London with a provincial station was a difficulty which is likely to hold up the extension of television to the provinces. Regarding the effective range of the transmitter, which was still considered to be 30-35 miles, he said that this could be considerably increased if "we could somehow contrive that all motor cars could be suppressed." The question was asked regarding the possibility of increasing the present power of the transmitter with a view to extending the range as a stop-gap measure until such time as the first provincial station was built. In reply Sir Noel said that the vision transmitter's power of 17 kW. would need to be increased some four times in order

to double the effective range. He pointed out that even then it would be serving a sparsely populated area.

Mr. C. O. Stanley, chairman of the R.M.A. Television Development Sub-committee, spoke forcefully on the present position of television. He said that the need of extending the service to the provinces was vital in order to convince the public that the service had progressed beyond the experimental stage. "While Members of Parliament still refer to 'experimental television' we cannot," he said, "convince the public that the preliminary stage is passed."

He caused a sensation when he stated that he did not think the lack of finance was the primary cause of the hold-up in extending television to the provinces. "I blame the G.P.O. entirely," said Mr. Stanley, "for the lack of television development."

BROADCASTING IN THE 40-METRE BAND

Comments from Both Sides of the Atlantic

FROM tomorrow, September 1st, the 40-metre band will no longer be the property of amateurs. It was decided at a Cairo Telecommunications Conference, held in February, 1938, to permit a number of broadcasting stations to transmit on frequencies between 7.2 and 7.3 Mc/s from Sept., 1939. Although a number of Governments have registered at Berne frequencies for future use, it is not yet known whether broadcasting stations will commence transmissions within this band immediately.

For some time Paris-Mondial has been transmitting on 7.28 Mc/s, despite protests from the A.R.R.L. and the R.S.G.B., and a Portuguese station has also begun transmission within this band. It is reported that the B.B.C. will eventually use two frequencies between 7.2 and 7.3 Mc/s.

In the August issue of *The T. & R. Bulletin* the question of short-wave broadcasting is raised and the query asked "Who listens to these short-wave broadcasts?" The writer continues "We go so far as to say that the audiences who listen regularly to most of the semi-propaganda stations are microscopically small."

Amateurs on both sides of the Atlantic are fearful as to the consequences of this encroachment upon what has so far been their preserve. In the July issue of *QST* was included a voting card on the question of asking the North American governments to permit telephony operation between 7.2 and 7.3 Mc/s. "The fear has been expressed," says *QST*, "that the usual 40-metre CW signal won't be able to compete effectively with strong carriers of foreign broadcasters. . . . It is argued that 'phone transmission would be better able to compete with carrier interference from foreign broadcasters. . . . And there can be no doubt that 'phones, given the chance, would make thoroughgoing occupancy and prevent the building up of any American audiences for these foreign stations."

The point stressed by the R.S.G.B. is that the short-wave broadcast interests already have a super-abundance of frequencies for the comparatively small listening public they serve.

It therefore remains to be seen what will happen during the next few months.



INTERESTING DATA on the propagation of ultra-short waves is being gathered by Mr. F. T. Bennett, of Guernsey, who regularly receives the B.B.C. television transmissions from Alexandra Palace. This reproduction is of an untouched photograph of the B.B.C. tuning signal as received by him. He uses a Marconiphone 701 television receiver which is preceded by two separate amplifier units in cascade. The output from the second amplifier is split and fed to the television receiver and a separate three-valve amplifier for sound only.

C-R TUBES IN TELEVISORS

TELEVISION receiver manufacturers have been recommended by the Radio Manufacturers' Association to fit protective glass over the cathode-ray tubes in televisions. Until such time as the construction of C-R tubes eliminates the necessity for a protective screen all television receivers must have

a sheet of heat-treated safety glass fitted in front of the tube.

For tubes over 16in. in diameter the minimum thickness of the glass is 3/8in.; for tubes with a diameter over 9in. and up to and including 16in., 1/2in. thick; and for tubes up to and including 9in. in diameter 3/16in. thick.

RADIOLYMPIA'S CINEMA

An Interesting Demonstration

SOME delay was caused in the opening of the special cinema at Radiolympia due to technical points raised by the L.C.C. licensing department. The first show was eventually given on Friday evening, two days after the opening of the exhibition.

A feature of the performance, which lasts about an hour and for which a charge of 3d. is made, is the demonstration of gramophone recordings of comparative quality in receivers of to-day and yesteryear. Contrary to expectations, the audience sit looking at a blank screen during this demonstration which is punctuated by the compère's remarks. The recordings, which

News of the Week—

are played on the turntables in the projection box are heard through the ordinary talkie speakers at the back of the screen.

There is a very marked difference in the quality of reproduction from the old and the modern sets demonstrated in the recordings. After a passage of music has been heard as reproduced by each of the two sets, the compère clearly explains what is the difference, i.e., the attenuation of upper musical frequencies, etc.

Of Doubtful Antiquity

The "old" set is referred to as "a receiver of a year or so ago." From its output it would appear to be "a receiver of ten years or so ago." The causes of electrical interference are demonstrated and the effects of some means of combating them are given.

Following the demonstration, which lasts for a quarter of an hour, the G.P.O. film "North Sea," which illustrates vividly the working of the G.P.O. trawler telephone service, is shown. In this, interesting shots of the Wick Post Office station, the apparatus on the trawler and the skipper actually operating the set are included. The method of sending out a Mayday call from the trawler is shown, together with the method in which it is handled by the coast station.

TYNE RADIO BEACON

THE Tyne Radio Beacon, erected by the Tyne Improvement Commission on the North Pier, Tynemouth, was formally inaugurated by Sir Arthur M. Sutherland, chairman of the Commission, on Monday, August 21st. The station, provided by Marconi, transmits under the call sign MMY on 988 metres with a note frequency of 535 c/s. The normal range is 50 nautical miles.

In the event of a failure in the town's electric supply the beacon would be operated by an emergency generating set.

In his inaugural address Sir Arthur said that the cost of the installation had been more than £1,000. "In 1938," he said, "there were 2,240 British ships and about 5,000 foreign ships fitted with direction finding apparatus. The system of wireless beacons was first introduced in 1924 at Nash Point in the Bristol Channel with the installation of a spark transmitter. In 1925 the first automatic beacon was erected at Round Island in the Scilly Isles, and there are now 34 similar beacons on the coasts of Great Britain and Eire and 450 in the world. 200 of these are in the United States of America."

**INTERFERENCE
SUPPRESSION****A Comprehensive Guide**

IN view of the probability that anti-interference legislation will soon be introduced, it behoves electrical engineers who have neglected the "lighter" branches of their art—including wireless—to learn something of the nature of interference and the methods taken to prevent it at the source.

It is largely to satisfy the demand that has arisen for information on this subject that "Radio Information Suppression," briefly reviewed in last week's issue, was written. This book constitutes a comprehensive survey of methods of suppressing electrical machinery, and deals not only with heavy industrial plant but also with light domestic appliances. The book is issued from the offices of *The Electrical Review*, Dorset House, Stamford Street, London, S.E.1, and costs 5s. (by post, 5s. 3d.).

**FRENCH NATIONAL
TRANSMITTER****Quadruple Aerial System**

THE new French National transmitter at Allouis, which is expected to start operations in September, embodies two independent transmitters of 450 kW each, and will work on the Radio-Paris wavelength of 1,648 metres. Each section of the quadruple aerial system is fed with currents having a relative difference of phase in such a way that vertical radiation is reduced and horizontal radiation (which is virtually omni-directional) is reinforced. It is anticipated that this will reduce short-distance fading.

The B.B.C. system of National and Regional programmes will be adopted by France next month when Radio-Paris operates at its new power. The two groups of stations given in our issue of August 10th will on alternate days become National and Regional.

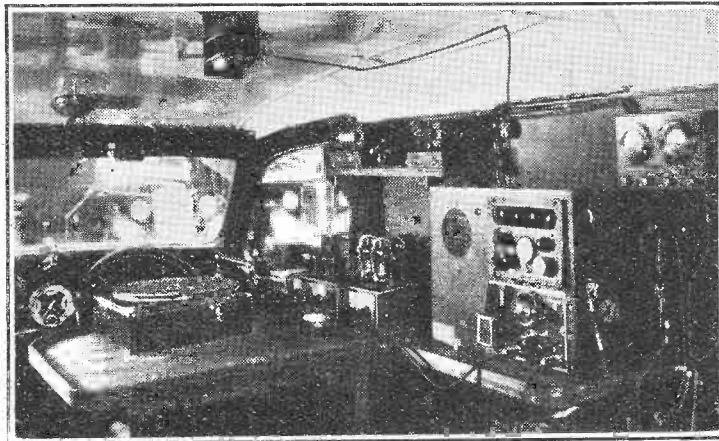

RADIO-PARIS has equipped several reporting cars, the interior of one of which is shown above. On the right is the short-wave transmitter which is used for the broadcasting of news for reception at headquarters.

**FROM ALL
QUARTERS****Continental Television Reception**

A NEW record for Continental television reception is reported from Beeston, Notts, where Mr. F. Weddle, who is a regular B.B.C. viewer, received the transmissions from Rome. The letters E.I.A.R. were clearly distinguishable although the sound was very faint. The distance is over 1,000 miles. The previous record was the reception of Rome in Guernsey, a distance of 900 miles.

"G" Station in Newfoundland

HAVE you heard G8XY or G8XZ? The station transmitting under these call signs on 42.22 and 117.55 metres (7.104 and 2.552 Mc/s) is erected at the base camp of the Public Schools Exploring Society's expedition to Newfoundland. Situated at Grand Lake, it is transmitting from 9 to 11 p.m. G.M.T. daily until September 6th.

Luxembourg in Short Waves

It was announced some time ago that Radio Luxembourg would commence transmission on short waves. It is learned that the wavelength to be used is 31.49 metres (9.527 Mc/s) and that transmissions, which will be announced in five languages, will be between 4 and 6 p.m. G.M.T.

I.W.T.

MR. HARRIE J. KING, the secretary of the Institute of Wireless Technology, having recovered from his recent illness will be making his customary visit to Radiolympia.

Correspondents Wanted

A READER of *The Wireless World* in British Columbia—Mr. J. J. Bouzek, P.O. Box 56, Stewart, B.C., Canada, wishes to correspond with other service-men in this country with whom he could discuss differences in British and Canadian radio servicing practice.

R.C.A. Profits

It is revealed by Mr. Sarnoff, president of the Radio Corporation of America, that the net profit of the Corporation and its subsidiary companies for the first half of this year was more than \$350,000 less than the corresponding period last year.

Studio in School!

RECORDING apparatus, flood-lighting, and balance and control rooms are now being fitted into the specially adapted studio at the Guildhall School of Music and Drama, London. Mr. Reginald Denham, a former student, who has had considerable experience as a producer, will supervise the television work. The studio will be completed and put into service in September.

Glasgow Wireless College

PREMISES at 3, Park Gardens, have been opened by the Glasgow Wireless College where there is accommodation for resident students. The college, which is associated with the Dundee and Aberdeen wireless colleges, is now enrolling pupils for the coming term.

Indian Radio Journals

THREE publications devoted to wireless have recently made their appearance in Bombay. They are: *The Indian Radio Review*, which aims at becoming "the vital link between the listeners and the broadcasting organisation"; *The Bombay Radio Times*, which is a technical monthly and includes the short-wave programmes from Germany, Italy and Japan; and *Radio Services*.

Radio Engineering

COURSES for the National Certificate in Radio Engineering have been arranged by the Borough Polytechnic on the lines recommended by the Radio Manufacturers' Association for the training of men who have entered, or wish to enter the radio industry. The courses, which spread over five years, include radio communication, advanced physics (acoustics, light and electricity), advanced theory of radio apparatus, high-frequency measurements, wave propagation and reception and television. A two-year course on radio service work is also given in the syllabus, which is obtainable from the Borough Polytechnic, Borough Road, London, S.E.1. Enrolment for the session which commences on Monday, September 25th, begins on Monday, September 11th.

Radio Society for Bishop Auckland

A SHORT Wave Radio Society is being formed in Bishop Auckland. Will any person interested please write to Mr. W. W. Field (G2GC), 5, Albert Hill, Bishop Auckland, Co. Durham, for full particulars of times and dates of the meetings.

Antiference

THE address of Antiference, Ltd., is King's Yard, Bayham Place, London, N.W.1, and not as given in our Show Report last week. Prices of television aerials produced by this firm are from 16s. 6d. upwards.

Short-wave Reception

HOW TO OBTAIN THE BEST RESULTS WITH MODERN SETS

ALTHOUGH it is only during the past few years that short-wave ranges have been included in domestic broadcast receivers as a matter of course, broadcasting on these wavelengths was in vogue for quite a long time before this. Most readers will remember the special units that could be obtained and which were used in conjunction with their existing sets to tune-in the short-wave stations.

Reception was not always as satisfactory as one might wish, but we were prepared to accept the fare offered and there is no gainsaying that many enjoyable hours were spent listening to events broadcast from a station several thousand miles away. Anyone who has sampled short-wave reception on sets of that period will fully appreciate how much better it is on a modern all-wave set. Improvements have, of course, been made in the design of the short-wave portion of receivers, but contributing in no small measure are the changes effected at the transmitting end. Years of study of short-wave propagation has enabled engineers to predict, with a fair accuracy, the best wavelength for any season and for any time of the day, while the wider use of special aerial systems that concentrate the energy radiated into the desired directions have vastly improved reception on the short waves.

It is quite true to say that there is no part of the world too remote to be reached by short waves, so that we in this country can listen to programmes broadcast from the Antipodes with almost the same facility as to those transmitted over a few hundred miles, though in the case of the former both wavelength and time of day become important factors.

Empire Broadcasting

Being so well provided with broadcast material on our medium and long wavebands we are inclined to look on the short waves as a third string, but in our Dominions and Colonies the short waves assume far greater importance, for they provide a direct link with the Motherland. The B.B.C. have no fewer than 18 frequencies in the short-wave region on which Empire programmes and news are radiated. These extend from 21.47 Mc/s (13.97 metres) to 9.05 Mc/s (49.59 metres) and the most suitable one is used for transmissions to each part of the Empire, according to the time of the day.

Under normal conditions the Daventry transmitters are active for just over 20 hours a day.

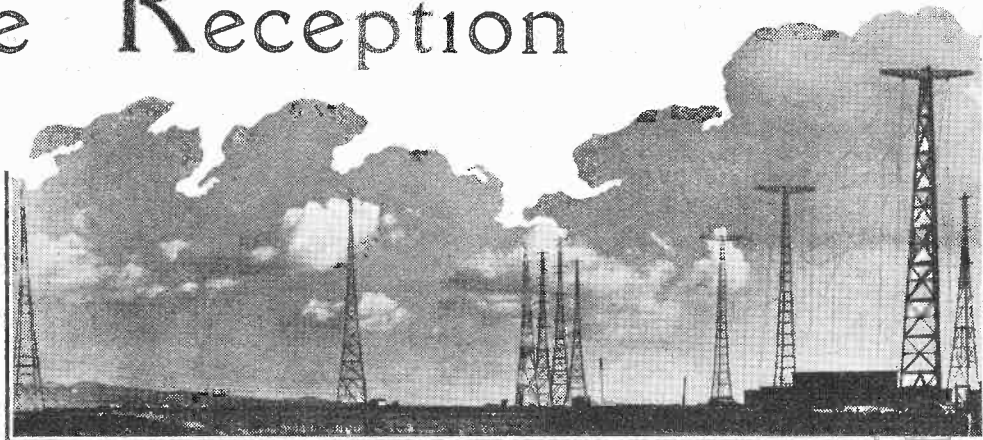

Italy's Imperial Short-Wave Centre at Prato Smeraldo, near Rome, is equipped with fourteen towers, varying in height from 180 to 300ft., which support directional and non-directional aerials. Of the seven transmitters at present in use, two have a power of 100 kW, two 50 kW and three 25 kW.

Contrary to what one might expect, these short-wave stations are not always well received in the south of England, owing to the directive nature of the aerials employed, to the phenomenon of "skip distance," and sometimes to a peculiar echo. This echo, which gives the effect of the speaker, orchestra or artists being located at one end of a very long bare room, will often help to identify the origin of the programme if the announcement is missed.

Echo is rarely heard on the Continental short-wave stations and the strength and

THANKS to the general use of higher power, to directional transmission and also to improvements in receiver design, short-wave broadcasting is now much more dependable than a few years ago. But full advantage cannot be taken of it unless the listener chooses the correct waveband for the time of day and for prevailing conditions

clarity of these transmissions is surprisingly good.

Germany operates an extensive short-wave service, much of which is transmitted in English, and Zeesen, the home of the stations, can be picked up on thirteen different frequencies between 21.45 Mc/s (13.99 metres) and 6.08 Mc/s (49.35 metres).

It is rarely necessary to listen below 6.0 Mc/s, i.e., above 50 metres, for short-wave broadcasting, as the majority of it is confined to six bands between 13 and 50 metres.

These are often referred to as the 13-, 16-, 19-, 25-, 31- and 49-metre bands, and as they are always clearly defined on all modern all-wave sets, the listener need not concern himself with the actual upper and lower frequencies of each.

Usually the short-wave broadcast bands are indicated by thickened bars on boxes on the scales, though there are some sets that give stations' names and indicating

lines as a means for identification, while in others the short-wave broadcast bands can be selected by push-buttons or similar mechanical devices.

"Marker" Stations

With a set where only a thickening of the scale line defines the broadcast band a useful tip for finding a station is to tune in one that is easily identified, and as near as possible in frequency to the wanted station, and then search carefully on the appropriate side of the marker station.

If it cannot be found on the first attempt try again a little later, as short-waves are often subject to considerable variation in strength, sometimes fading almost to inaudibility, while at others they are strong enough to necessitate the use of the volume control. AVC cannot compensate for this degree of fading, though it will keep a signal at fairly constant volume if fading is not too severe.

It is also necessary to make sure that the time and wavelength are correct, for if the programme one is after happens to be radiated from one of a chain of stations, this organisation will have several wavelengths at its disposal.

Examples of this are the U.S.A. short-wave stations. The programme may be listed as coming from Bound Brook, but this station has the use of four frequencies, one in each of the 13-, 16-, 31- and 49-metre wavebands, and may use either the call sign W3XAL or WNBI (ex W3XL). Wavelengths are chosen according to the time of day and season, though at this time of the year the 16-metre wavelength is used more than any other under the call sign WNBI and with an aerial beamed on Europe.

In general, this station will be at its best during the afternoon and early evening, but may be affected by bad fading as darkness falls. Late evening reception will as a rule be best on the longer wavelengths, such as 25 and 31 metres, in which case Schenectady WGEO (ex W2XAF) in the 31-metre waveband, or Wayne W2XE in the 25-metre band might provide the best fare. The vagaries

Short-wave Reception—

of the short waves preclude making definite statements concerning the best band to listen-in to at any particular time of the day, since often the shorter ones, i.e., 16 metres, are good signals quite late in the evening, while the 19-metre stations often remain steady and quite reliable up to midnight GMT.

The general tendency, however, is for the shorter wavelengths to predominate during daylight and the longer after night has fallen. One point that should be borne in mind when listening to U.S.A. stations is that some of them use aerials beamed on Europe while others serve the South American continent. The former will always provide the strongest and steadiest signal. The published programmes usually state the times when the transmission is beamed in our direction.

A station that recently has been receivable at good strength in this country is

Three methods are employed for the frequent changes in wavelength at the B.B.C. Empire station. One method is the plug-in type of coil, shown here, which is wheeled into position on rails. The overhanging projection on the right carries the grid tuning circuit. In the centre are the two large tubular turns of the main anode inductance between which is the feeder-coupling coil. The other two methods of wave-changing are by the use of continuously variable inductances and a turntable fitted with four sets of pre-tuned circuits.

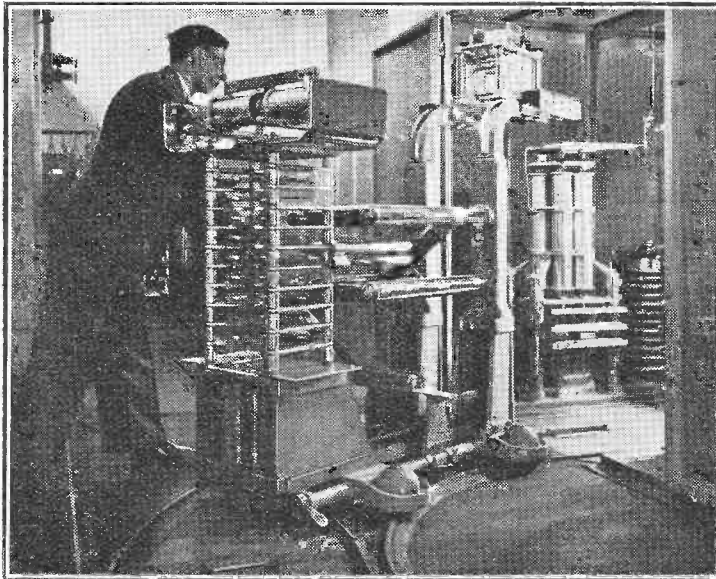

the Chinese station XGOY at Chungking. As it works on 25.21 metres and with a power of 35 kilowatts, the late evening, i.e., between 8 and 11 p.m. GMT., is the best time to listen. It shares this wavelength with the Rome station I2RO13, but as the wavelength generally used by Rome in this band is the 25.4-metre one, Chungking has a clear channel. A news bulletin in English can often be heard about 10.0 p.m. GMT and occasional talks in English are transmitted before the news. This station has been consistently good for some time past.

Australian stations are best looked for in the early mornings between 6 a.m. and 8 a.m. GMT, both Sydney VK2ME on 31.28 metres and Melbourne VLR on 31.32 metres being receivable about this time when conditions are favourable.

Some of the Russian short-wave stations are particularly strong and are to be heard at various times of the day in the 19-, 25-, 31- and 49-metre wavebands. Midday news or talks in English are sent out on 19.35 metres, while in the evening, and on either 31.25, 31.51 or 49.75 metres, talks in English are usually transmitted at 9 p.m. GMT.

Though only a few examples have been given, these will suffice to show that there is plenty of interesting broadcast matter to be found on the short waves. Particular stress has been placed on the use of English by most countries for talks and news bulletins, as some listeners might feel that it is hardly worth while tuning in to foreign stations if they do not understand the language. There are, of course, always the musical items in the programmes, and often these alone justify the little trouble involved in finding a particularly elusive station.

So far nothing has been said about the actual receiver or the best type of aerial to use. For short-wave reception a receiver of good sensitivity is desirable, and for preference it should be a superheterodyne. One with an RF stage before the frequency-changer will always give the best signal-to-noise ratio, other things being equal.

aerial it might be tolerated, but as few distant stations will be strong enough to generate an AVC voltage, slight fading of the signal will be immediately apparent. By using a good outdoor aerial the receiver will have a strong signal to deal with, and normally will be operating at lower sensitivity owing to the generation of a considerable AVC voltage. Now a fading signal can be compensated for by the reserve sensitivity of the set, so that reception will be steadier and for the most part quieter.

The aerial should be as high as possible, and where local electrical interference is troublesome one of the all-wave anti-interference type can be installed. Always use a good earth connection and fit a lightning arrester to the aerial.

Little advantage is to be gained by erecting an aerial solely for the short waves unless reception is required from one particular direction. Most of the special aerials have marked directional properties, and it is this feature that is largely responsible for the improvement effected in the optimum direction.

Local Television Relay**Distribution from a Central Receiver**

IN view of the relatively high cost of television receivers, arrangements which will enable the receiving equipment to be cheapened are always of interest. Many schemes have been suggested for blocks of flats, where a central receiver can be provided and the demodulated picture and sound signals distributed to the various subscribers living in the flats so that a simplified and consequently cheaper receiver can be used by the subscribers.

In order to cheapen the subscribers' receivers still further, it has been proposed to generate and synchronise the deflecting currents in the central receiver and to transmit these currents over feeders to each receiving point and thus to avoid the expense of synchronising and scanning circuits in each individual receiver. A practical difficulty arises in carrying out this, however, as on account of imperfect matching between the scanning coils of the receivers and the feeder carrying the scanning currents it is not always possible to avoid reflections.

According to a report from the Siemens and Halske laboratories, this difficulty can be largely overcome by winding the deflection coils of the receivers in several sections and building them by means of suitable condensers into an artificial line properly terminated to have the same surge impedance as the feeder. The deflection currents can then be fed to the scanning coils without setting up any reflections. The individual sections of each deflection coil can be arranged in series along the axis of the cathode-ray tube.

BEETHOVEN 1940 SETS—A CORRECTION

IN the note on page 159 of the August 17th issue, it was stated that the P44 portable was of the all-battery type. Actually the LT is derived from an unspillable 14 AH accumulator and HT from a 90-volt battery with quick-fitting contacts.

The price of the Model B43 mentioned in the same note has been fixed at 8½ guineas. This is a 5-valve superhet with QPP output and an illuminated four-colour tuning scale.

Two or more short-wave ranges will be better than one, while the set should tune down to at least 16 metres, but preferably to 13 metres. A few years ago we would have advised a very careful examination of the tuning dial and scale, as with a few exceptions the tuning-in of short-wave stations required not only great patience but no little skill.

Whilst tuning will still have to be carried out with care to obtain the best results, so many improvements have been made in the design of scales and slow-motion tuning devices, added to which press-button selection of short-wave bands is now being adopted, that the purchaser of a new set need not really concern himself with these. Attention must, however, be given to the installation of the set in the home.

The object should be to provide the set with the best possible signal, which can only be done by erecting a good aerial. Short waves can be received on quite a short indoor aerial, but the set must then be operated at maximum sensitivity, and the inherent receiver noise will then be audible as a background accompaniment. If this were the only drawback of a short

Letters to the Editor

The Editor does not necessarily endorse the opinions of his correspondents

Replaceable Components

IN *The Wireless World* of July 27th, there is an Editorial on the problem of tuning scales for the Montreux plan. There would, in my opinion, be no problem at all were tuning scales readily accessible, but in the majority of receivers replacement of these scales can be effected only through the removal of the chassis, or at least of several components.

I have never yet discovered any adequate reason whatever why tuning scales, and still more such things as pilot lamps, should not be made easily accessible for changing or replacement.

A further point is that tuning scales often become dirty in course of time, especially in the case of mains-driven receivers, which get considerably warmed-up when they have been switched on for an hour or so, with consequent infiltration of dust behind the glass covering of the scale. Were the glass cover so arranged that it could be readily removed, this unsightly dust could be cleared out periodically. As things are now, it is most tantalising to be able to see these tuning scales and pilot lamps "so near, and yet so far!"

T. J. E. WARBURTON.

St. Leonards-on-Sea.

Reproduction Levels

THE correspondence in *The Wireless World* on reproduction level has now reached a very interesting stage, and I would like to express a few ideas which appear to have been overlooked in the discussion so far.

Mr. Hughes, and the others, agree "that for perfect reproduction the correct level is essential."

As this elusive perfect reproduction has not yet been invented, the arguments are all based on an imaginary ideal, and that for real quality reproduction it is not essential to have the correct level. Mr. Hughes appears to have the psychology of listening all wrong. When we listen to the reproduced version of an orchestra we want to be able to hear the correct proportions of the original.

We know that when we hear music reproduced to-day it has first to pass through the control room, and it is altered from the original according to the control engineer's own idea of balance.

When we keep our level of reproduction down—not by any means to a low level—our ears attenuate the high and low notes, so why should we not use tone correction? After all, what is the criterion of good reproduction? When we can sit back and receive the utmost satisfaction from it, and we can say that it was magnificent. Does it really matter if it was not quite like the original? We must not lose sight of the fact that as we cannot hear the original at the same time as the reproduced, we cannot make a comparison.

Many individuals' ears—those of musicians included—attenuate more than others, so why not make it possible for them to recreate the tonal balance as required by them through tone compensation?

If everyone had the same idea of tonal

balance, then they would all be cramped into a very small space should they decide to hear an evening's music at the Queen's Hall.

As different orchestra conductors have their own standards of tonal balance, I cannot understand why we should try to fix a standard for this.

There are too many variables from the original to what we hear to fix a standard.

To my mind, the question of reproduction level and quality is bound up with the individual's taste, and what he wants in tonal balance to suit his musical feelings; so long as he has a means of adjusting his wants to his satisfaction, it should not be argued that it is wrong.

He has to listen to reproduction through his own ears and not through the medium of another person's—which may interpret balance quite differently.

Scientists, while giving us plenty of food for thought in their articles on quality and distortion forget that we listen to reproduction through the medium of a loud speaker and not from a cathode-ray oscillograph.

London, N.4.

R. C. HARRIS.

ALL those interested in this correspondence will appreciate the clear summary and conclusions given by "Cathode Ray," but there still seems to be one important point which has not been fully considered, namely, this "listening ear at the original performance," which has been taken as an arbitrary standard. Does its position always coincide with that of the microphone, and in any case does the B.B.C. know anything about it?

I have always understood that the B.B.C. bears in mind the artistic quality of the ultimate reproduction of its musical programmes, and to this end frequently deviates from orthodox musical practice with regard to the placing of performers and instruments, even in the concert hall, while studio arrangements are usually made entirely from the point of view of the "mike." Furthermore, when two or more microphones are used the various components of the sound waves may be combined with their relative amplitudes such as could not be heard by an ear in any one position. I believe the usual routine is to balance up a concert performance at rehearsal using a loud speaker for reproduction; surely the loudness level used for this is of some importance? Do the engineers work to some approximate standards and assume, for example, that there is an ideal listening distance for a given type of performance? Some authoritative information about this side of their work would be very welcome, as in the absence of any standards most of our tone control adjustments would appear to be haphazard and meaningless except as a matter of individual taste.

It appears to be agreed unanimously that in circumstances where it is necessary for the reproduction to be appreciably below normal there is some loss of realism or naturalness, but while some listeners find it possible to restore this by tone adjustment, others do not. If we may define naturalness as the degree to which the reproduction resembles the idea in the listener's mind of how a similar performance should sound, surely we have here an explanation of the only actual

WIRELESS IN THE NAVY

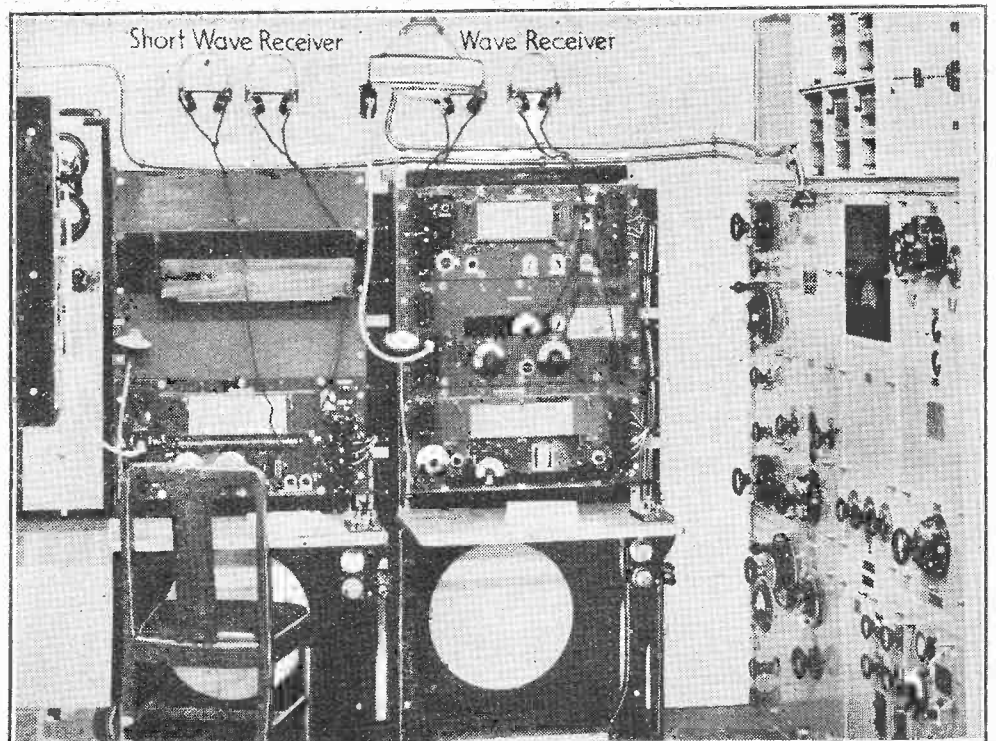

Until recently the civilian seldom had an opportunity of seeing inside the wireless "office" of a man-of-war. This privilege is given him at Olympia, where the complete transmitting and receiving equipment of a destroyer forms one of the "sideshows"

difference of opinion which has arisen, for we have introduced a factor which is likely to be different for each listener. I personally find I am much more critical of the quality of reproduction of a concert when I am familiar with the auditorium where it is being given, and often find it noticeable that the microphone is not in the position I would be in myself.

From all these rather indefinite conjectures the fact does emerge that a properly designed tone control will sometimes be found helpful to a critical listener if it is used intelligently, and with some thought as to the conditions at the other end; as a second best some degree of automatic tone compensation can be provided for the non-intelligent, but as the latter will probably not be very critical it seems doubtful if it is worth while.

It is to be hoped that some of the points raised in discussions of this nature may lead to a closer co-operation between musician and technician; I am convinced that in the near future electrical reproduction of music will prove to be of considerable importance in the progress of the whole art.

Stanmore, Middx. C. C. BUCKLE.

Call-sign Duplication ?

I SEE from your issue of August 10th that Mr. Stanley Garnett complains of piracy of his call-sign G4AW. He may be interested to know that I have a station two hundred yards from me who has G4AW as a call-sign, and cards on the wall to that effect. Have the P.O. issued two G4AWs? I wonder. J. E. THOMSON, G3RY. Stockport, Ches.

Shaver Interference: Views from Canada

THE letter from Mr. J. A. Yearsley in *The Wireless World* some time ago on the very vexatious matter of interference caused by electric shavers is rather apt to lead others astray.

My experience and experiments in suppressing the fierce radiation of these pests of the ether have shown that the cure (if and when possible) is nothing like so simple as your correspondent would have us believe. In the several different makes of shaver which I have investigated, only one has a condenser across the contact points, and this is of only very small capacity (estimated about 500 micro-microfarads), of the mica type. In this particular machine the shaving head (i.e., cutter) is insulated from the motor by a Bakelite insert.

Long ago I tried out the rather obvious cure, in a shaver which had no capacity whatever installed by the makers, of putting in a 0.01 mfd. 500 V (1,000 V test) midget condenser directly across the contact-breaker. That condenser lasted rather less than one minute! Another (same rating) stood up for several minutes—long enough to discover that sparks about $\frac{1}{16}$ in. long could be drawn from the cutter to any part of the user's anatomy, accompanied by a decidedly unpleasant pricking sensation. Again the condenser broke down under the enormously high voltage induced in the motor windings. This machine, of course, did not have the cutter-head insulated from the motor. Operating voltage was 110 V, 60 c/s.

A suitable small resistance in series with the by-pass condenser will take the edge off the extremely steep and high wave-fronts of induced voltage, and also destroy most of the RF-suppressing qualities. Also, where, in the average shaver, can one find

room for anything but the simplest and tiniest of devices inside the casing?

A suitably designed choke-plus-capacity filter, installed at the right spot (not at the wall-plug), is effective with some machines (next to useless with others, particularly the cheaper varieties).

Meanwhile, the manufacturers of the gadgets seem to know nothing, and care rather less, about the interference caused, or means of preventing it.

SYDNEY R. ELLIOTT.

Allenby, B.C., Canada.

Wireless in the Wilds

"DIALLIST" has on a number of occasions sought information on various primary cells for the solution of the battery problems of the exiles in the wide open spaces.

In these days junk motor cars fetch 50s. each. Every one has a 6- or 12-volt dynamo with cut-out and ammeter. You could probably get a dozen at any breaker's yard for 5s. or 10s. each. The rotors are on ball bearings, and they start charging at about 2 amps at some 500 r.p.m.

The only other requirements seem to be a 6- or 12-volt battery, a simple windmill, and an old bicycle. Then, even if the wind drops, there's always leg-power.

FREDK. GRISLEY.

Leigh-on-Sea, Essex.

Start Point: Complaint from the West

A FLY remains in the ointment of quality reception in these parts. Start Point is a great asset, but one is precluded from using broad tuning or a wide band filter by the fact that Rennes-Bretagne occupies the next channel, only 10 kc/s away, and geographically only just across the Channel, about 160 miles away.

I suppose it would be too much to expect the B.B.C. to swop over wavelengths now so that stations adjacent geographically shall not be neighbours in frequency, too. Having waited fifteen years for a decent service, the part of the country showing the highest proportion of licences to population will meekly wait another nine months (until the Montreux Plan comes into force) for a few more crumbs to be thrown to it. So we see that it is not sufficient to lay down that stations sharing a channel shall be set far apart or use directional transmission; the

same rule should apply to cases like the present; Start Point has the necessary equipment, but Rennes hasn't, and it would hardly be reasonable to ask an inland station to reduce its radiation over an important part of its service area.

L. J. VOSS.

Plympton, Devon.

"Free Grid's" Speed Indicator

"FREE GRID'S" speed indicator is very interesting. I cannot, however, refrain from questioning the use of the Doppler principle as an explanation of its action, both by the author and "Henry Farrad."

According to the Theory of Relativity the velocity of light with regard to any observer is the same whatever the relative velocity of the source and observer. Radio waves, being also an electromagnetic radiation, will act in the same way, and will pass the airman at the same velocity independent of the speed at which he is flying. So they can scarcely change their frequency unless they are also prepared to change their length.

The velocity of light, three times 10^{10} m. per sec. is also laid down as a limiting velocity greater than which no velocity can exist. Thus the wave cannot have a velocity greater than this relative to the airman. If it did it would possess peculiar properties such as that of being in two places at once.

"PARASITE."

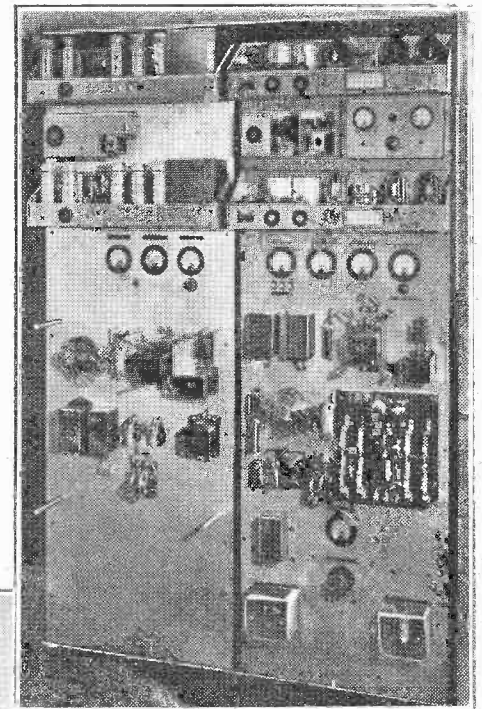

WIRELESS CONTROL of the lighthouse on Fourteen Foot Shoal, Lake Huron, maintained by the United States Lighthouse Service, is carried out from a point on shore about four miles distant. The extensive equipment comprises lantern, fog signals and a radio-beacon; any of these devices can be put into operation from the remote point. Power is supplied from a 110-volt accumulator battery, the charging equipment for which is automatically started and stopped. The inset photograph shows apparatus in the lighthouse control room.

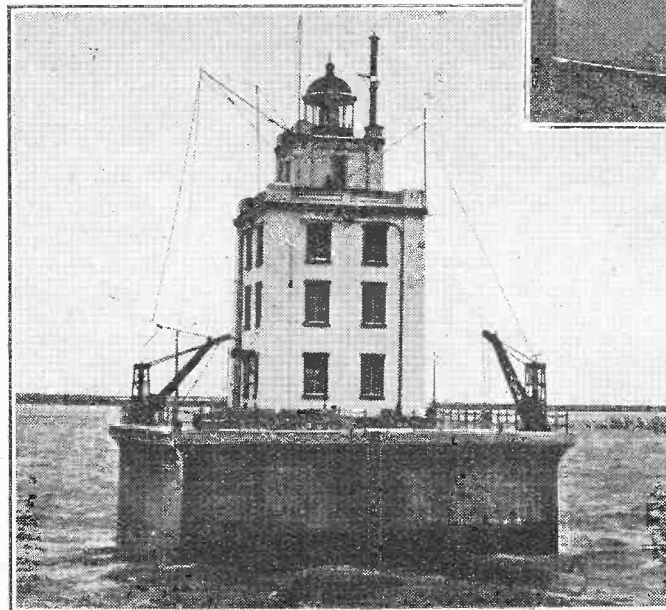

What is "Fluctuation Noise"?

By "CATHODE RAY"

IF you have any experience of very high-amplification receivers you know that unless they are tuned to a station of at least moderate strength, or are provided with a quietening device, they emit a noise that may be anything from a faint hiss to a roar. You may think that this is due to atmospheric, or a defect in one of the valves, or some such cause. Well, perhaps it is. But even when the aerial has been disconnected (to keep out atmospheric), and suppressors have been put in the main leads (to keep out any other sort of interference), and all defective valves or components have been replaced by good ones, the set still utters a rushing sound if it amplifies enough. It may be possible to reduce the noise corresponding to a given amplification, but only to a certain extent. Devices such as "Q.A.V.C." silence it by cutting down the amplification, so don't count.

The noise that is left after all avoidable causes have been eliminated is known by so many names—thermal agitation, fluctuation noise, Johnson noise, Schottky effect, "schrotteffekt," shot effect, etc.—that it is not surprising if readers get muddled. Actually there are two closely related phenomena: the first three of the foregoing names apply to one, which occurs in all ordinary electric circuits; and the last three apply to the other, which occurs in the spaces between the electrodes of valves.

Both are due to the ultimate structure of matter. A distant view of a sand beach after the tide has gone down gives the im-

If water is examined, even through a microscope, it is impossible to distinguish between one particle of water and another; in fact, in spite of modern education, probably most people suppose it is quite continuous. Anybody with even a smattering of scientific knowledge knows, however, that water, air, glass, copper and everything else is actually composed of small particles separated by wide open spaces. The wideness of the spaces is, of course, relative: the most powerful microscope is totally inadequate to reveal them, still less the particles themselves.

A large proportion of the particles are of the particular type known as electrons, and whenever an electron moves there is an electric current. Moreover, all electrons are always moving very rapidly (unless the temperature happens to be 273 degrees below zero Centigrade, and that eventuality can be neglected for practical purposes, though it is very interesting and important theoretically). Since electric currents consist of the movements of electrons, and all matter is composed largely of electrons, and all the electrons are moving, it seems as if electric currents must be everywhere. This disagrees with experience (fortunately!), for two reasons. One is that many of the electrons, especially those in what we know as insulators, are bound up with particles of the opposite electrical polarity; so the electric currents resulting from movements of these

is that their own movements cancel out.

This is one of the so-called statistical laws of nature, which means that it is true if the average is taken of a sufficiently large number. It is a statistical law of nature that when a coin is fairly tossed the chances of its being heads or tails are equal. If you toss a coin 10 times you may get seven heads and three tails. It is just possible that you might get ten tails and no heads. But if you tossed it 1,000,000,000 times the number of heads and tails would each be almost exactly 500,000,000. As electrons exist in vastly greater quantities than this, even in drops of water and grains of sand, the chances of

FACTORS THAT SET A LIMIT TO RANGE

any appreciable surplus happening to move in one direction at the same moment are small. But not nil. In the ordinary way these unbalanced movements are not detectable, but the enormous magnification that is possible with a multi-valve amplifier is sufficient to reveal them. The electrons in a piece of wire may be thought of as a crowd of people or a swarm of gnats rushing about absolutely at random. Over a space of time the chances are in favour of as many electrons moving up the wire as down it; so the electric currents cancel out. But if it were possible to account for every single electron out of the trillions present, it would be found that at one moment a few more were moving up the wire; the next moment the tendency might be reversed; occasionally a fairly large number might happen to be moving together. Therefore, although the average current is nil, there is a very small current continually fluctuating in direction and strength. The nature of this current has been closely studied, and it is rather a paradoxical thing (as it is with the tossed coin) that although the result in any one particular case is entirely unpredictable, yet the average result—which is the only one of any practical importance where electrons are concerned—is known with a large degree of accuracy. So accurately, in fact, that it is used for the calibration of certain instruments such as standard signal generators.

Temperature Effect

In the first place, the higher the temperature the faster the electrons move, and therefore the greater current a given number causes. Then the greater the resistance of the circuit or component the greater the voltage set up by these small currents. Finally, the currents include all frequencies equally, from zero up to high radio frequencies at any rate. So you can reduce the amount of noise in the output of a receiver by narrowing the band of frequencies accepted by the amplifier. Even if one wasn't obliged to do this in order to tune out interfering stations, it would be

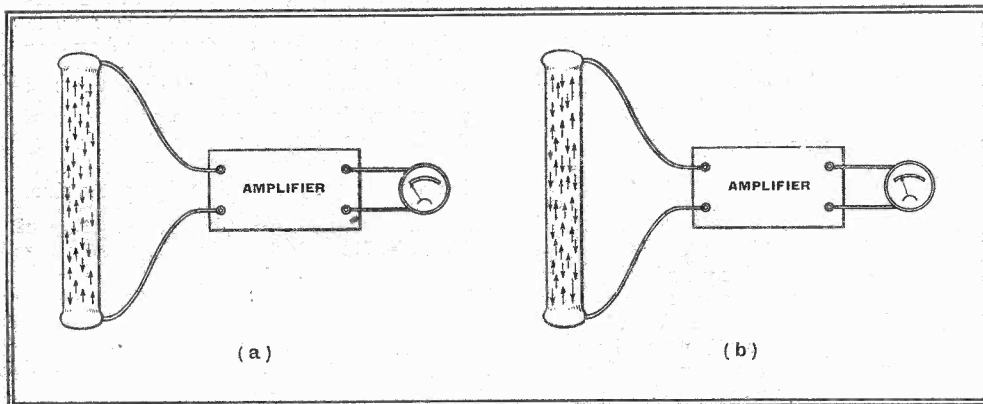

The electrons in, say, a resistor that is not connected to any source of electricity are moving about at random. At the instant represented by (a) equal numbers are moving up and down (those moving sideways, etc., are not shown), and the voltages developed by these minute currents in the resistor all cancel out. At another moment (b) it happens that more are moving up than down, so there is a small resultant voltage that can be detected by the use of sufficient amplification. With a resistance of about 100,000 ohms, the average may be a few microvolts. A tuned circuit is equivalent to a high resistance so far as fluctuations of the resonant frequency are concerned.

pression that it is one continuous substance; whereas close examination soon shows it to be made of separate small particles. These particles can be crushed into still smaller fragments, of microscopic size.

married couples exactly cancel out. The other reason is that unless there is any special influence at work even the free electrons do not move in any one direction more than another and therefore the effect

What is "Fluctuation Noise" ?—

worth doing it to reduce noise. Reducing the resistance of, say, the first tuned circuit (which is equivalent to a high resistance at the frequency to which it is tuned) is no good, because it reduces the "signal" more rapidly than the noise. So actually it pays to make the tuned-circuit resistance as high as possible, which is done by making the series resistance of the coil and condenser as small as possible. As regards the temperature, you can get a very satisfactory reduction in noise by cooling the first tuned circuit with liquid helium. But you might find it rather a troublesome treatment to apply!

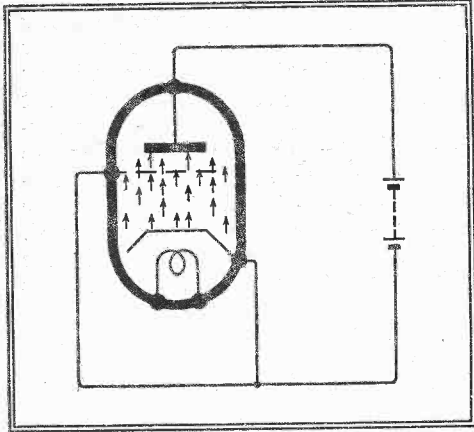

In a vacuum valve the electrons are all going the same way; but the current is not quite free from fluctuations, because the number of electrons in transit varies from moment to moment.

Why have I referred particularly to the first tuned circuit? Because it is followed by the largest amount of amplification. If the first stage amplifies 100 times, then it is obvious that the noise due to the second tuned circuit is negligible compared with the hundredfold noise from the first. Even when the amplification is small—around ten times—as it is at television wavelengths, the second circuit is hardly worth considering compared with the first.

How about the shot effect? The current through a valve is rather a different sort of affair from those in wires and other things. It crosses empty space, so there is no permanent swarm of gnats to dart to and fro. No electrons are allowed in the vacuum except on business. When a current is drawn across to the anode by the HT battery or other attraction, it consists of a one-way stream of electrons released by the heating of the cathode. But although it is one-way, and the electrons are very small, there are slight irregularities in the rate of arrival, just as the pressure on a steel plate peppered by a thousand machine guns would be subject to continual slight variations.

At first, a valve was treated as a resistor heated to the temperature of the cathode; but although that gives something like the right answer in certain cases, the matter was found actually to be much more complicated. It has now become the practice to refer to the shot noise generated by a valve under given working conditions in terms of the resistance at the input (grid

to cathode) that would be necessary to produce the same amount of noise voltage. A typical equivalent resistance is 10,000 ohms. This means that the shot noise of the valve with its input short-circuited is the same as that produced if shot noise could somehow be abolished and all the noise were due to thermal agitation in a 10,000 ohm resistor, amplified by the valve. At medium broadcast frequencies the tuned circuit resistance is likely to be about 100,000 ohms; perhaps more. So the added effect of 10,000-ohm shot noise is not very significant. But for short waves the tuned circuit resistance, allowing for the input resistance of the valve itself, may be less than 10,000 ohms, and the shot effect of the valve in question would then contribute the majority of the noise.

Shot noise is decided largely by the design of the valve, but one way in which it

can be kept to a minimum is by avoiding passing any anode or screen current that is not accompanied by at least a corresponding increase in amplification.

In practice it is impossible to eliminate either type of noise entirely, so they are often referred to as inherent amplifier noise, and form a natural boundary limiting the amount of amplification that it is practicable to employ. The very elaborate receivers used for important services—for example, the Post Office receiver I described a few weeks ago—are ingeniously contrived for getting the maximum signal with the minimum noise; and although the total number of valves used may be enormous the number of actual stages between aerial and output is never very large. The idea of connecting up 50 stages of amplification and receiving a 1-watt transmitter anywhere just doesn't work!

Random Radiations

By "DIALLIST"

For Overseas—and Home

ONE thing that may strike you at Olympia is that some of our wireless manufacturers have at last awakened in good earnest to the vast possibilities of the overseas markets. Till lately, they didn't seem to be bothering much about these, though *The Wireless World*, which has readers everywhere and has therefore excellent sources of first-hand information, has repeatedly urged them to be up and doing ere others stepped in and skimmed the cream. What is specially interesting is that *The Wireless World* told them from the very first just what kind of set was needed. "In the marketing of these export sets," writes one firm to me, "British manufacturers found that there was a considerable demand for an almost identical type of set amongst connoisseurs and short-wave enthusiasts in this country." In other words, what the overseas market—the Empire part of it anyhow—wants is a set that is first rate on the short waves as well as on the medium; not a medium- and long-wave set with a single short-wave range added as a make-weight. And that is also the kind of receiver that so many of us at home have been asking for for so long. Visit the export section of the Exhibition and see for yourself, if you haven't done so already.

High-speed Tuning

The chief innovation this year in the press-button receivers with motor-operated tuning is that the pointer travels literally in double-quick time from one station to the next when you dab with the forefinger. No bad thing, that; for in some of the early models you had to wait an unconscionably long time whilst the pointer crawled over the dial. There's one aid to quicker manual tuning, too, that I'd like to see on more receivers. That's a big tuning knob, with a recess or hole in or near the rim into which you can stick your forefinger when you've come to one end of the scale and want to go back to the other. I'm glad to see that automatic wave-range changing is to be found in many of the sets. It may seem a small thing, but I don't think it's altogether trifling; an automatic set should be as fully automatic as you can make it,

and there's no sense in having to push two buttons if one will do the work.

Vision Receivers

A fine show of television receivers this year. I can't claim to have counted them, but I am told there are over a hundred different models on the stands of the twenty odd firms displaying them. I've just been talking to a cricket widow whose husband is reputed to wear out innumerable pairs of trousers each season on the benches of famous cricket grounds as he watches Test and county matches. She complains bitterly that she seldom sees him once the cricket season has started. "Why not," I asked, "put in a television set and keep the wanderer at home?" She is seriously thinking it over. She fears, though, that if the B.B.C. is televising from Lord's, he'll take it with him to the Oval and so be able to watch two matches at once. Anyway, there's a fine choice of vision receivers for cricket widows or others, and I'm very much impressed with the excellence of the reproduction given by even the least costly models. No one can say now that television hasn't genuine entertainment value.

The Conventions

To-day sees the last of the "popular technical conventions" which have been such an excellent feature of this year's show. In case you'd forgotten it, the subject today is "Television," and the rendezvous, the Conference Room at 6 p.m. Admission is free so long as you're inside Olympia. These conventions are just what has been wanted for a long time. The lay papers have mostly ceased to give their readers any information about the technical side of wireless, so that the man in the street has little idea of what progress is being made. All that he gathers in the ordinary way is that receivers have been getting cheaper for some time, though not changing much, and that, depending upon what paper he reads, the B.B.C. is either a magnificent provider of entertainment or the world's prize collection of incompetent half-wits. That being so,

he doesn't see any reason for discarding the old set in favour of a new one, so long as it makes some kind of intelligible noise when he switches on.

Wireless Back-numbers

Many manufacturers of wireless receivers would, I'm sure, be surprised if they knew the kind of reproduction that many people are content with, not knowing that there is anything better. It is no more and no less a fact that there are heaps of folk who put up with poor volume, with horrible background noises, with woolly speech and with music minus most of the treble plus carpet-beater "bass" because they believe that wireless can't be any better than that. Most of us have heard such sets; have also heard their owners express mild astonishment when it was hinted that their performance wasn't quite up to modern standards. It seems a pity that, with the transmissions as excellent as they are now, this kind of things should go on.

All-dry

LATELY I've been trying one of the newest "all-dry" portables to see how I liked it. I've had for some time an older portable of the suitcase type by a first-class maker and I thought it would be interesting to try the two against one another. I don't mean as station-getters, for there the "all-dry" would naturally win hands down, since it is a superhet while the other is a straight designed for short- rather than long-range working. It was volume and quality that I had in mind to compare. The old set wins as regards quality; it has a rather better loud speaker and the background is dead silent. But the "all-dry" can produce remarkable volume and handle it without undue distortion. In fact, what these little valves with their minute requirements in the way of LT and HT current can do is amazing. I was surprised to find how many foreign stations the "all-dry" would bring in—and not too badly either. After dusk, I was able to pick up at respectable strength a round score of stations in France, Holland, Germany, Italy and even further

afield. It seems to me that now its use of dry batteries for all current supplies makes it really light, the portable is worth cultivating.

Virtues of the Frame

IT'S some time now since I used a frame aerial for DX purposes, and I must say that when I was trying that portable on foreign stations I was impressed by the useful addition to overall selectivity provided by the directional properties of that kind of collector. If it wasn't for the fact that it is so prone to pick up interference in the home to-day, I think I'd dig out an old frame that is lying about somewhere and adapt my big set for use with it. I once had a superhet which worked off a diamond-shaped frame with 18-inch sides. That was in the days before interference became so bad, and I used to say of it that its selectivity was such that you could almost separate a station from its own call-sign. Using a frame there is one kind of interference—not man-made—whose effects you can sometimes defeat. Atmospheric are often radiated from a definite centre of disturbance and so arrive from a fixed direction. When this is happening rotate the frame till you find the position that gives a minimum of atmospheric annoyance. Then listen to any stations that can be picked up without moving the frame, bringing up the volume when necessary by means of the volume control. The frame might, I suppose, be used in the same way against man-made static coming from a single source; but it can't do anything when it's arriving from all points of the compass.

HENRY FARRAD'S SOLUTION

(See page 216)

WHEN a battery is old its internal resistance is high; and changes in current through the output pentode cause changes in voltage across this battery resistance, which are passed through the coupling condenser, stepped up by the

transformer, and applied to the grid. Whether they are in a direction that increases the current changes or reduces them depends on the way the transformer is connected. If the former, the amplification around the loop may be enough to cause continuous low-frequency oscillation; as appears to be so in the present case. By reversing one of the transformer windings the positive feedback is converted into negative feedback, with some loss of volume. If this loss is to be avoided, it is necessary to decouple the circuit, as, for example, by connecting a condenser of large capacity across the HT battery.

Television Programmes

Sound 41.5 Mc/s

Vision 45 Mc/s

The "Come and be Televised" feature from 11 a.m. to 12 noon will continue throughout the duration of Radiolympia, but from Monday, September 4th, the usual film for demonstration purposes will be given during that period. The National or Regional programme will be relayed on 41.5 Mc/s from approximately 7.45 to 9 p.m. daily.

THURSDAY, AUGUST 31st.

3, Fashion Parade with Bobby Howell's Band.* 3.30, Gaumont-British News. 3.40, 261st edition of Picture Page. 4-4.30, The Zoo, O.B. from Regent's Park.

9, Elizabeth Welch in songs. 9.10, Night shots from the Zoo. O.B. from Regent's Park. 9.30, British Movietonews. 9.40-10.20, 262nd edition of Picture Page.

FRIDAY, SEPTEMBER 1st.

3, Cabaret, with Bennett and Williams. 3.20, British Movietonews. 3.30, Cartoon Film. 3.35, Mantovani and his Orchestra. 4.5-4.30, The Zoo, O.B. from Regent's Park.

9, Variety, with Nosmo King and Hubert, Adelaide Hall and Bobby Howell's Band.* 9.30, Ray Ventura et ses Collegiens. 10, Gaumont-British News. 10.10, Film. 10.20-10.30, Pas Seul No. II.

SATURDAY, SEPTEMBER 2nd.

3, Punch and Judy. 3.10, Cartoon Film. 3.15, Gaumont-British News. 3.25, "Bits and Pieces," light entertainment. 4-4.30, The Zoo, O.B. from Regent's Park.

9, Cabaret Cartoons. Cartoons by Harry Rutherford. Cabaret with Trudi Binar. 9.40, British Movietonews. 9.50, Shove Ha'Penny. A match described by Charles Garner. 10.5, Cartoon Film. 10.10-10.20, Ena Baga, pianoforte.

SUNDAY, SEPTEMBER 3rd.

9.5-10.20, "The Circle" by Somerset Maugham. Cast includes Alan Wheatley and Belle Chrystall.

MONDAY, SEPTEMBER 4th.

3-4.15, "A Cup of Happiness," a comedy by Eden Phillpotts. Cast includes Leon M. Lion, Roger Livesey and Amy Veness.

9, Beatrice Lillie with Sam Walsh at the piano. 9.10, Speaking Personally. 9.20, British Movietonews. 9.30, Cabaret. 9.50, "Nancy's Puppets," presented by Nancy Worsfold and Elspeth Holland. 10.5, Cartoon Film. 10.10-10.20, Picture Story by Robert Gibbings.

TUESDAY, SEPTEMBER 5th.

3-4.20, "The Pelican," a play by F. Tennyson Jesse and H. M. Harwood. Cast includes Athole Stewart and Mabel Terry-Lewis.

9, Gaumont-British News. 9.10-10.25, "Knock, or the Triumph of Medicine," a comedy by Jules Romains. Cast includes Marius Goring and Marjorie Bryce.

* O.B.'s from Radiolympia.

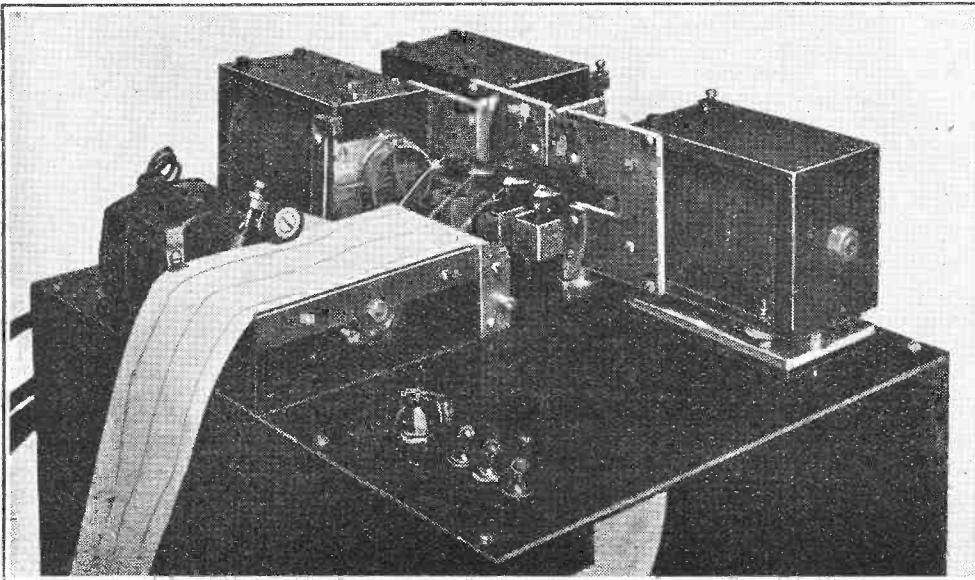

ELECTROENCEPHALOGRAPH: A feature of the Ediswan stand at Radiolympia is a device for recording brain activity. Known as the Electroencephalograph, it has been developed by Mr. Grey Walter and is manufactured by the Edison Swan Electric Co., Ltd. Four pads are placed on the head of the patient to give four points of electrical connection and are connected via high-gain amplifiers to three recording pens. Brain activity causes variations in the output and the presence and position of tumours can be gauged from a comparison of the three traces. The above photograph shows the recording mechanism; it is connected by cables to the amplifiers which are of special low-noise design.

Recent Inventions

SHORT-WAVE MAGNETRONS

A TYPE of short-wave magnetron has recently been developed in which a cathode is placed outside one end of a "split" cylindrical anode, the electrons from the cathode being forced by an external magnetic field to travel through the anode in a spiral path. They are then absorbed by a tuned Lecher-wire circuit shunted across the two split halves of the anode.

In one example of this type—called the Sentron—the anode is divided longitudinally into two semi-cylinders; whilst in another type, called the Osaka tube, the cylindrical anode is cut up at right-angles to its axis, into two or more rings. Alternatively, the anode could, with advantage to operating efficiency, be split up in both these ways, i.e., into rings and semi-cylinders, but this introduces difficulties in exciting the various parts of the anode in proper phase.

According to the invention the expedient is adopted of dividing the cylindrical anode by two "cuts" which run spirally along the main axis. In this way the electrons coming from one or both cathodes meet the magnetic field, across the slots or gaps in the anode, at right-angles to their own movement, thereby increasing the efficiency of the magnetron as a short-wave oscillator.

Telefunken Ges. für drahtlose telegraphie m.b.h. Convention date (Germany) January 26th, 1938. No. 505426.

ELIMINATING INTERFERENCE

LOCAL interference due to inductive fields does not usually extend very far above the earth.

Brief descriptions of the more interesting radio devices and improvements issued as patents will be included in this section.

The aerial A is therefore placed as high as possible, and is earthed through a coil L, which is coupled to a secondary coil L₁ and a balanced transmission line B to the receiving set R. The primary winding L₂ of the input transformer to the set is protected by an earthed screen S, and its midpoint is also earthed. The two wires of the transmission line are twisted, or spaced, so as to match the impedance of the two transformers. Since the line B is symmetrically connected to earth, it need not be screened since any inductive pick-up is automatically balanced out. The line B should be kept as far away as possible from the earth-lead E.

E. M. Lee; F. R. W. Stafford; H. G. Stedman; and Belling and Lee, Ltd. Application date, November 10th, 1937. No. 505838.

USW RADIO ALTIMETER

THE figure shows a radio installation for determining the height of an aeroplane above the ground, particularly at night or in foggy weather. Ultra-short waves, from one to five metres in length, are transmitted from dipole aerials T, which are arranged to give minimum radiation in the direction of the corresponding receiving dipoles R, mounted at the other end of the wings. Other means are also provided to prevent direct pick-up, so that reception is substantially confined to the wave which is returned after reflection from the ground.

For altitudes up to three times the wing spread, unmodulated ultra-short waves give accurate results, the elevation being indicated by the phase difference between

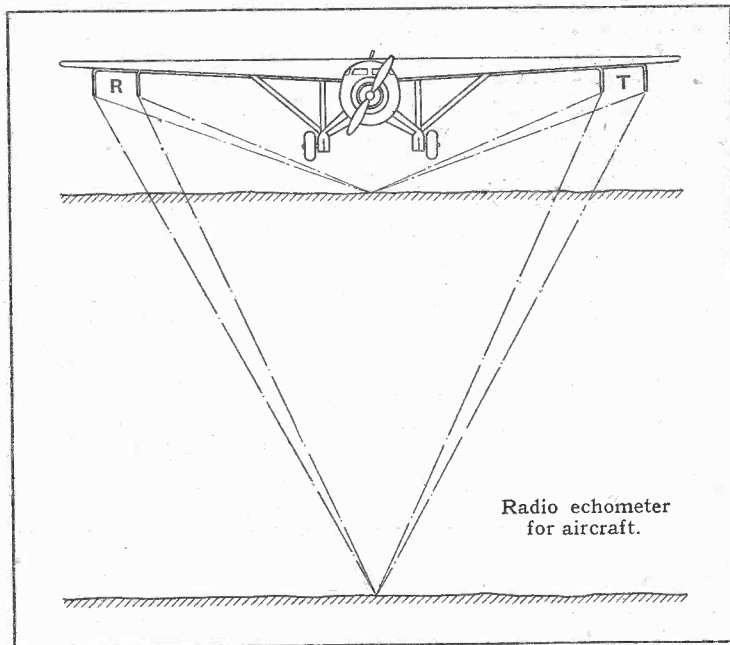

the reflected and outgoing wave as measured by a synchroscope. For higher altitudes, a short carrier wave is modulated by a longer wave, having a frequency of say, 60 kc/s for a cruising height of 2,000 feet. The phase of the reflected wave, after demodulation, is then compared in a synchroscope with the 60 kc/s frequency used to modulate the outgoing wave.

Standard Telephones and Cables Ltd. (Assignees of R. A. Heising). Convention date (U.S.A.), May 15th, 1937. No. 504767.

AVC FOR TELEVISION

ALTHOUGH it is desirable to use automatic volume control to prevent the fading of television signals, a special difficulty arises owing to the fact that the general level of the carrier wave is deliberately varied at the transmitter in order to convey to the receiver a voltage representative of gradual changes in the average or background illumination of the picture. If the normal type of AVC were applied to such a signal, this valuable DC component would be automatically wiped out.

Accordingly, instead of using changes in the amplitude of the carrier wave as the source of the AVC voltage, the required control voltage is obtained from the synchronising impulses, which are first passed through a "storage" circuit consisting of a condenser shunted by a resistance. When fading occurs, the amplitude of the synchronising signals naturally

falls off, and they develop an imperfect or truncated shape when discharged from the storage circuit. This change of shape is then utilised in the process of rectification to develop an AVC voltage of varying value.

Marconi's Wireless Telegraph Co., Ltd.; D. J. Fewings; and R. J. Kemp. Application date August 25th, 1937. No. 501349.

TELEVISION INVISIBLE OBJECTS

AN aeroplane or other object, even when hidden by fog or mist, can be "seen" by focusing a beam of infra-red light upon it, and then picking up the reflected rays on a special type of television transmitter. Infra-red light having, say a wavelength of 10 microns will pass through fog thick enough to disperse and scatter ordinary white light.

The ordinary photo-sensitive screen used in television will not respond to the long infra-red rays required for this kind of work. The inventors accordingly provide a special screen made of a sheet of mica coated with a very thin film of the rare metal germanium. This possesses a high thermoelectric coefficient, and so develops localised potential differences corresponding to the shape or outline of the invisible object.

Marconi's Wireless Telegraph Co., Ltd. (assignees of H. A. Iams). Convention date (U.S.A.) December 30th, 1936. No. 505686.

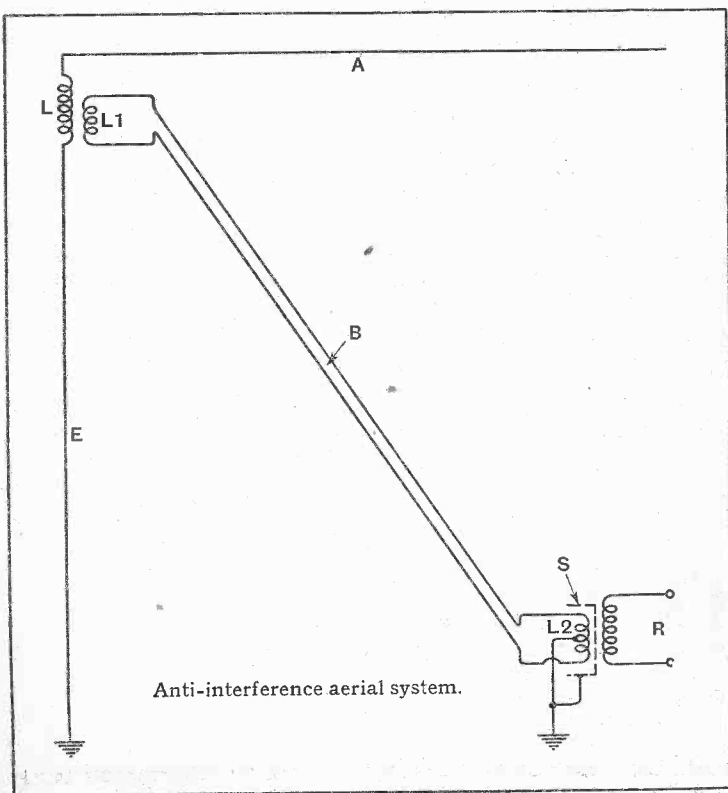

The British abstracts published here are prepared with the permission of the Controller of H.M. Stationery Office, from specifications obtainable at the Patent Office, 25, Southampton Buildings, London, W.C.2, price 1/- each.

A NEW CONCEPTION OF HIGH FIDELITY REPRODUCTION

4 Vital Facts about

GOODMANS

Infinite Baffle LOUDSPEAKER

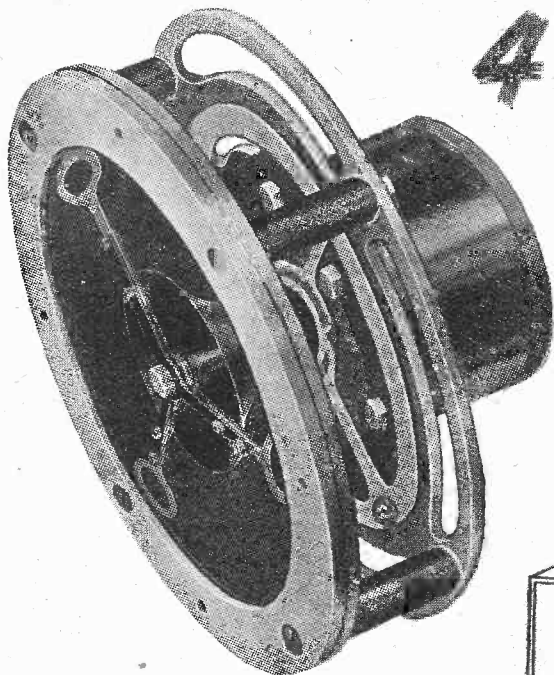

- (1) Unique diaphragm suspension ensures absence of resonance. No "colouration."
- (2) High Flux Density Magnet and light diaphragm assembly provides exceptionally good transient and high note response.
- (3) Unusually flexible suspension eliminates frequency doubling.
- (4) Entirely new and unorthodox chassis design, of extreme mechanical rigidity ensures freedom from resonance and reflection.

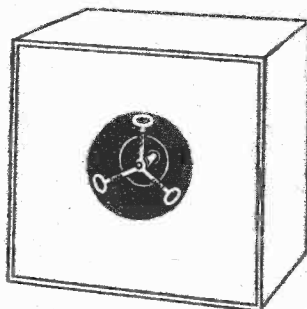

GOODMANS "Infinite Baffle" Loudspeaker makes possible in the home a fidelity of reproduction hitherto confined to the laboratory. In effect the result is that of employing a baffle not less than 8 ft. square but, adapting the principle of the "Helmholtz" resonator, Goodmans have produced a loudspeaker which is only 18" cube with a smooth and true response to the lowest audible frequency.

SPECIFICATION:—Useful frequency range 30 c.p.s. to 12,000 c.p.s. Power Rating Capacity: 15 watts A.C. Peak. Speech Coil impedance: 2.5 ohms. Weight: 42 lbs. Supplied fitted in plain loudspeaker case 18" x 18" x 18", finished grey.

£10 (Excluding Transformer).

High grade cabinets also available in various finishes.

POST THIS COUPON FOR FREE TECHNICAL BOOKLET

To:—GOODMANS INDUSTRIES LTD., Lancelot Road, Wembley, Middx.

Please send me full details of the new "Infinite Baffle" Loudspeaker together with a copy of your 20-page technical booklet "The Attainment of an Ideal." I enclose 1½d. stamp towards postage.

Name.....

Address.....

W.W. 31.8.39. Attach this to your card on letterheading.

GOODMANS INDUSTRIES LTD., Lancelot Rd., Wembley, Middx. Phone: WEMBLEY 4001 (5 lines)

For Listeners to America

Every week WORLD-RADIO publishes two "American Pages."

In them short-wave listeners will find a guide to the American programmes which can be received most satisfactorily in this country.

News from America, stock market reports, concerts and speeches, variety programmes and dance bands—you can hear them all if your set brings in the short waves IF YOU KNOW THE RIGHT STATION AND THE RIGHT TIME.

This is only one of the many indispensable features to be found in each issue of World-Radio, the BBC's foreign programme journal.

For full enjoyment and appreciation of short-wave programmes place a regular order, where you buy your "Wireless World," for a weekly copy of

World-Radio

3d. Every Friday

Mention of "The Wireless World," when writing to advertisers, will ensure prompt attention.

CLASSIFIED ADVERTISEMENTS

NOTICES

THE CHARGE FOR ADVERTISEMENTS in these columns is

12 words or less, 3/- and 3d. for every additional word.

Each paragraph is charged separately and name and address must be counted.

SERIES DISCOUNTS are allowed to Trade Advertisers as follows on orders for consecutive insertions, provided a contract is placed in advance, and in the absence of fresh instructions the entire "copy" is repeated from the previous issue: 13 consecutive insertions 5%, 26 consecutive, 10%; 52 consecutive, 15%.

ADVERTISEMENTS for these columns are accepted up to FIRST POST on MONDAY MORNING (previous to date of issue) at the Head Offices of "The Wireless World," Dorset House, Stamford Street, London, S.E.1, or on SATURDAY MORNING at the Branch Offices, 8-10, Corporation Street, Coventry; Guildhall Buildings, Navigation Street, Birmingham, 2; 260, Deansgate, Manchester, 3; 26b, Renfield Street, Glasgow, C.2.

Advertisements that arrive too late for a particular issue will automatically be inserted in the following issue unless accompanied by instructions to the contrary. All advertisements in this section must be strictly prepaid.

The proprietors retain the right to refuse or withdraw advertisements at their discretion.

Postal Orders and Cheques sent in payment for advertisements should be made payable to ILLIFFE & SONS Ltd., and crossed & Co. Notes being untraceable if lost in transit should not be sent as remittances.

All letters relating to advertisements should quote the number which is printed at the end of each advertisement and the date of the issue in which it appeared.

The proprietors are not responsible for clerical or printers' errors, although every care is taken to avoid mistakes.

ARMSTRONG

QUALITY YEAR

The age of "gadgets" has passed. To-day the marvel of radio has become commonplace through use and familiarity. In our opinion there is a vital reason for purchasing a new set—Quality! Since last season we have worked exclusively to this end and believe with these new chassis we have achieved our objective.

—OUR NEW 1940 CHASSIS—

include the following:

SUPERHET - STRAIGHT 10 - VALVE ALL-WAVE

HIGH FIDELITY RADIOGRAM. MODEL SS10 incorporating Two Independent Circuits, Superheterodyne and Straight, having R.F. Pre-amplifier and R.C. Coupled Push-Pull Triode Output capable of handling 8 watts.

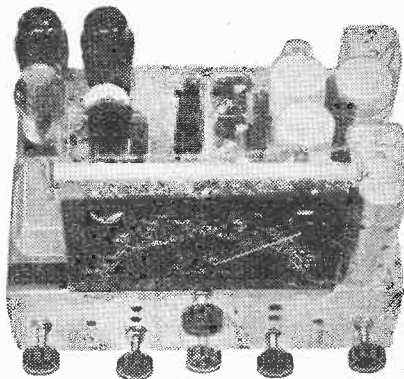

The circuit of the SS10 is unique. When used as a STRAIGHT receiver two HF stages are in operation with A.V.C. Diode Detector is used for distortionless detection together with Triode Push-Pull output. A turn of only one knob is necessary to switch from "Superhet" to "Straight." The Gramophone Amplifier has been specially studied and records can be reproduced with excellent quality..... 12 gns.

SEE AND HEAR THEM ON STAND 69 RADIOLYMPIA

MODEL SS2B—10-V SUPERHET-STRAIGHT 2-WAVEBAND HIGH FIDELITY RADIOGRAM

This model has all the outstanding features of the SS10, the circuit being identical in every respect, except that the chassis is designed for Broadcast bands only, no provision being made for Short Waves. It has the same extremely lively performance on "Superhet" and high quality reproduction on "Straight"..... 11 gns.

MODEL AW38—8-V ALL-WAVE SUPERHET

This radiogram chassis has R.C. Coupled Push-Pull Output capable of handling 6 watts. This being our Quality Year we have carefully studied the design of our more economically priced models and it's now possible for those requiring quality with economy to satisfy their desire. 8 gns.

MODEL AW125PP—12-V 5-BAND ALL-WAVE RADIOGRAM (12-550 continuous, 1000-2000 m)

with R.F. Pre-Amplifier, 2 i.F. stages with Variable Selectivity. Manual R.F. gain control and 10 watts R.C. coupled Triode P.P. Output.

Readers need no introduction to this most popular model, so favourably reviewed by *The Wireless World* on Jan. 5th last. Basically, it remains the same but the frequency response has been still further improved to conform to the higher standard of quality..... 17 gns. We have set ourselves this year.....

Illustrated Art Catalogue giving full specification and details of our 8 Models will be sent upon request.

All chassis on 7 days' approval, carriage paid.

12 MONTHS' GUARANTEE.

ARMSTRONG MANUFACTURING CO.
WALTERS ROAD, HOLLOWAY, LONDON, N.7
(Adjoining Holloway Arcade.) 'Phons: NORTH 3213.

NUMBERED ADDRESSES

For the convenience of private advertisers, letters may be addressed to numbers at "The Wireless World" Office. When this is desired, the sum of 6d. to defray the cost of registration and to cover postage on replies must be added to the advertisement charge, which must include the words Box 000, c/o "The Wireless World." All replies should be addressed to the Box number shown in the advertisement, c/o "The Wireless World," Dorset House, Stamford Street, London, S.E.1. Readers who reply to Box No. advertisements are warned against sending remittances through the post except in registered envelopes; in all such cases the use of the Deposit System is recommended, and the envelope should be clearly marked "Deposit Department."

DEPOSIT SYSTEM

Readers who hesitate to send money to advertisers in these columns may deal in perfect safety by availing themselves of our Deposit System. If the money be deposited with "The Wireless World," both parties are advised of its receipt.

The time allowed for decision is three days, counting from receipt of goods, after which period, if buyer decides not to retain goods, they must be returned to sender. If a sale is effected, buyer instructs us to remit amount to seller, but if not, seller instructs us to return amount to depositor. Carriage is paid by the buyer, but in the event of no sale, and subject to there being no different arrangement between buyer and seller, each pays carriage one way. The seller takes the risk of loss or damage in transit, for which we take no responsibility. For all transactions up to £10, a deposit fee of 1/- is charged; on transactions over £10 and under £50, the fee is 2/6; over £50, 5/-. All deposit matters are dealt with at Dorset House, Stamford Street, London, S.E.1, and cheques and money orders should be made payable to Illiffe & Sons Limited.

SPECIAL NOTE.—Readers who reply to advertisements and receive no answer to their enquiries are requested to regard the silence as an indication that the goods advertised have already been disposed of. Advertisers often receive so many enquiries that it is quite impossible to reply to each one by post. When sending remittances direct to an advertiser, stamp for return should also be included for use in the event of the application proving unsuccessful.

NEW RECEIVERS AND AMPLIFIERS

RADIO CLEARANCE, Ltd.

ALL Lines Previously Advertised Still Available.

ALL Orders Over 5/- Carriage Free; under this amount sufficient postage must be included with order.

ALL Enquiries Must Enclose 1½d. Stamp.

RADIO CLEARANCE, Ltd., 63, High Holborn, W.C.1. [8859]
Holborn 4631.

CHALLENGER Range for 1940.

CHALLENGER RADIO CORPORATION.—2d. stamp for illustrated catalogues of battery, battery-mains, car radio and mains sets; 63/- to £28.—Challenger Radio Corporation, 31, Craven Terrace, London, W.2. Nearest point Lancaster Gate Station. [8862]

CROSLEY 1939 Brand New, 8v. 4wb., £6/6; 10-valve 5wb., £7/15.—Superadio, Dantzic St., Manchester. [8852]

AMAZING Offer.—Famous 7-valve push button 1339 models in maker's sealed cartons, issued 13½ gns.; £5/19/6; list free.—Shippers, 18, Corporation St., Manchester. [0639]

ARMSTRONG Co.—After many years at our old premises at Camden Town we have removed to a new building in Warlters Rd., Holloway, N.7 (see displayed advertisement).

ARMSTRONG Amplifier Division Has Removed to New Premises at 94, Camden Rd., N.W.1. In addition to our standard range of 6- and 12-watt push-pull high fidelity amplifiers and local station feeder units, we manufacture equipment for special purposes, pre-stage units, electronic mixers, tone control units, etc.

ARMSTRONG Are Always Pleased to Assist in the Solution of Special Problems; details of standard equipment free on request.

ARMSTRONG Co. (Amplifier Division), 94, Camden Rd., N.W.1. [8752]

£5/15.—Ambassador 6778 Universal 7-valve chassis and speaker (10in.), four band, R.F. stage; a few only, being surplus production, at this low price; cash with order, money refunded if not genuinely satisfied.—Ambassador Radio Works, Hutchinson Lane, Brighouse, Yorks. [8812]

CAR RADIO

1939 Automatic, £3/15; aerials, 8/6; suppressors, 1/-; 12v. resistances, 3/6.—Superadio, Dantzic St., Manchester. [8853]

1939 Models from 4½ gns., 6 new car aerials, from 9/6; trade enquiries solicited; lists free.—Shippers, 18, Corporation St., Manchester. [0622]

PUBLIC ADDRESS

VORTEXION P.A. Equipment.

IMITATED, but unequalled.

WE Invite You to a Demonstration.

A.C.-D.C. Dance Band Amplifier, 10 watts output, complete in case, with moving coil microphone, speaker and cables, weight 22lb.; 12 gns.

A.C.-20 15-20-watt Amplifier, 38-18,000 cycles, independent mike and gram, inputs and controls, 0.037 volts required to full load, output for 4, 7.5, and 15 ohms speakers, or to specification, inaudible hum level, ready for use; 8½ gns. complete.

C.P. 20 12-volt Battery and A.C. Mains Model, as used by R.A.F., output as above; 12 gns.

A.C.-20, in portable case, with Collard motor, Piezo pick-up, etc., £14; C.P.20 ditto, £17/17.

50-WATT Output 6L6s, under 60-watt conditions, with negative feed back, separate rectifiers for anode screen and bias, with better than 4% regulation level response, 20-25,000 cycles, excellent driver, driver transformer, and output transformer matching 2-30 ohms impedance electronic mixing for mike and pick-up, with tone control, complete with valve and plugs; £15.

COMPLETE in Case, with turntable, B.T.H. Piezo pick-up and shielded microphone transformer; £20.

80-WATT Model, with negative feed back; £25, complete.

120-WATT Model, with negative feed back; £40, complete.

250-VOLT 250 m.a. Full Wave Speaker field supply unit; 25/-, with valve.

ALL P.A. Accessories in Stock; trade supplied.

VORTEXION, Ltd., 182, The Broadway, Wimbledon, S.W.19. 'Phone: Lib. 2814. [8241]

TANNOY 25-watt Amplifier, Ad-on-Unit, A.C. mains, complete; £10.—Easco, 18w, Brixton Rd., S.W.9. [0643]

"PARTRIDGE P.A. Manual," standard handbook on electro-acoustics, amplifiers, and audio circuits; price 2/6 (free to trade).

"PARTRIDGE Amplifier Circuits," describes many modern constructional amplifiers, 2w. to 45w. output, battery, A.C.-D.C., etc.; price 2/- (no free copies).

PARTRIDGE, N. B.Sc., A.M.I.E.E., King's Buildings, Dean Stanley St., London, S.W.1. [0630]

MICROPHONES, moving coil, 29/6; bio-transverse, 37/6; Rothermel crystal, £3/5; Velodyne, £3/15.—Superadio, Dantzic St., Manchester. [8857]

ALEXANDER BLACK, Ltd., pioneers of hiring microphone amplifying equipment since 1928. Booklet on request.—55, Fbury St., S.W.1. Sloane 6129. [0598]

PUBLIC Address Contractors Can Hire P.A. Vans, loud speakers, microphones and equipments of all types from Hire Dept., Gramplan Reproducers, Ltd., Kew Gardens, Surrey. Tel.: Richmond 1175-6-7. [0618]

VORTEXION 50 W AMPLIFIER

£15 in Chassis Form

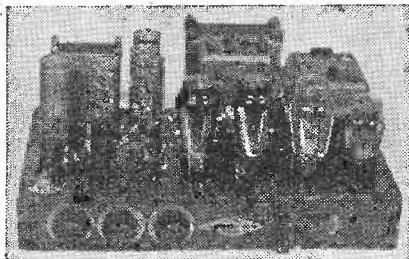

VORTEXION, LTD., are offering their new 50 W amplifier at £15 as a chassis with valves and plugs, or at £20 complete in black leatherette-covered cabinet with Collaro turntable, piezo-electric pick-up and shielded microphone transformer.

A pair of matched 6L6's with 10 per cent. negative feed-back is fitted in the output stage, and the separate HT supplies to the anode and screen have better than 4 per cent. regulation, while a separate rectifier provides bias.

The 6L6's are driven by a 6F6 triode connected through a driver transformer incorporating feedback. This is preceded by a 6N7, electronic mixing for pick-up and microphone. The additional 6F5 operating as first stage on microphone only is suitable for any microphone. A tone control is fitted, and the large eight-section output transformer is available in three types:—2-8-15-30 ohms; 4-15-30-60 ohms or 15-60-125-250 ohms. These output lines can be matched using all sections of windings and will deliver the full response (40-18,000 c/s) to the loudspeakers with extremely low overall harmonic distortion.

Write for Illustrated Catalogue.

We are 25 minutes from Olympia and can give full demonstrations of any model.

CALL AND SEE US!

Vortexion, Ltd., 182 The Broadway, Wimbledon, S.W.19. Phone: LIBerty 2814.

AMBASSADOR

ALWAYS

FINEST PERFORMANCE & VALUE

Send for details

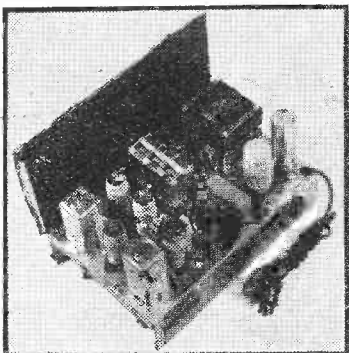

MODEL 6779

CASH PRICE

£11

with Valves and Speaker A.C. ONLY

SPECIFICATION:

Six valve super-het chassis using MAZDA Octal valves. Powerful R.F. stage on all bands covering 12.5/52 metres, 175/550 metres, 1,000/2,000 metres. Large plate glass dial. Electrical Band Spreading. Sensitivity control. New High Speed A.V.C. Automatic distortion cancellation. Electro dynamic reproducer with 40/8,000 response. 6.8 watts output. Heavy plated chassis total weight 37 lbs.

Wholesale and Export Enquiries Invited

AMBASSADOR RADIO WORKS

HUTCHINSON LANE, BRIGHOUSE, YORKS

Telephone: 283

NEW MAINS EQUIPMENT

VORTEXION Supply G.P.O., B.E.C., L.P.T.B. Why not you?

ALL Models Super Shrouded, primaries screened and tapped, 200-250v., filaments C.T.

ANY Model Fitted 5v. or 6.3v. Filaments if Required.

500-0-500 150 m.a., 4v. 4a., 2.5a., 4v. 2a., 4v. 2a., 4v. 2a., 35/-; 400 or 350v., same price.

500-0-500 120 m.a., 4v. 4a., 4v. 2.5a., 4v. 1-2a., 4v. 1-2a., 28/-; 400v. or 450v., same price.

425-0-425 150 m.a., 4v. 8-10a., 4v. 2.5a., 4v. 1a., 4v. 1a., 32/-.

350-0-350 120 m.a., 4v. 4a., 4v. 2.5a., 4v. 1-2a., 21/-; with extra 4v. 6a., 25/-.

350-0-350 75 m.a., 4v. 2-4a., 4v. 1-2a.; 18/-.

250-0-250 60 m.a., 4v. 2-4a., 4v. 1-2a.; 15/-.

AUTO Transformers, 100-120 to 200-240v., 80 watts, 11/-; 120 watts, 14/6; 200 watts, 21/-; 250 watts, 25/-; 300 watts, 28/-; 500 watts, 47/6.

W.W. Q.A. Output Transformer, 21/-.

MICROPHONE Transformers, in heavy magnetic shielding; 12/6.

CHOKES.—30h., 60 m.a., 7/6; 7-13h., 120 m.a., 12/6; 30h., 150 m.a., 15/-; 25h., 150 m.a., 21/-.

TRANSFORMERS and Chokes to Any Specification.

CAR Battery Charger, 6 and 12v., 1½ to 2 amperes; 30/- complete.

VORTEXION, Ltd., 182, The Broadway, Wimbledon, London, S.W.19. Telephone: Liberty 2814. [8860]

NEW LOUD-SPEAKERS

SINCLAIR Speakers for All Types.—Pulteney Terrace, Copenhagen St., N.1. [0603]

BAKERS New Corner Horn Speakers, triple cone versions; from 29/6, and surplus speaker bargains.—Bakers Selhurst Radio, 75, Sussex Rd., South Croydon. [8728]

LOUD-SPEAKERS

SECOND-HAND, CLEARANCE, SURPLUS, ETC.

3,000 Speakers from 5/6 each, P.M. and ensigned 4in. to 14in., including several Epoch 18in.—Sinclair Speakers, Pulteney Terrace, Copenhagen St., N.1. [0591]

TRANSMITTING APPARATUS

A.C.S. RADIO, specialists in short wave apparatus, communication receivers, including Hallicrafters, National and R.M.E. transmitting equipment, valves and components. Send for free catalogue to A.C.S. Radio, 16, Gray's Inn Rd., W.C.1. Holborn 9894-5. G2NK, Technical Manager. [0550]

G5N1—The oldest and largest distributor of amateur equipment transmitting and receiving; short-wave catalogue, 1/6d. G5N1 70-page Manual, 7/6d., post free; authorised direct distributor for Collins, National, R.M.E., Thordarson, Hammerlund, Biley, Taylor, Eimac, etc., etc.—44, Holloway Head, Birmingham. [0531]

CABINETS

A CABINET for Every Radio Purpose.

CONVERT Your Set into a Radiogram at Minimum Cost; surplus cabinets from noted makers under cost of manufacture (undrilled); 30/- upwards; motors at wholesale prices.

"FIT-A-GRAM" Cabinet, 31x17x15, 21/-.

UNDRILLED Table Console and Loud-Speaker Cabinets from 3/6.

INSPECTION Invited; photos loaned to country cus tomers.

H. L. SMITH and Co., Ltd., 289, Edgware Rd., W.2. Tel.: Pad. 5891. [0485]

DYNAMOS, MOTORS, ETC.

ALL Types of Rotary Converters, electric motors, battery chargers, petrol-electric generator sets, etc., in stock, new and second-hand.

A.C.-D.C. Conversion Units for Operating D.C. Receivers from A.C. Mains, 100 watts output, £2/10; 150 watts output, £3/10.

WARD, 46, Farringdon St., London, E.C.4. Tel.: Holborn 9703. [0518]

RECORDING EQUIPMENT

ALL Recording Discs and Materials in Stock, tracker units, £4/7/6; recording motors, £3/17/6.—Write for further details, Will Day, Ltd., 19, Lisle St., W.C.2. [0595]

FEIGH Recording Sets are Within Reach of All; ball bearing gear box, worm drive, traverser; records on any disc, Morse, speech or music; diamond cutter-pickup on tone arm, the set 37/6; 6in. blanks, 3/3 doz.; 10in. discs, 7/- doz.—Electradix, 218, Upper Thames St., London, E.C.4. [0620]

L.R.S.

FOR

ARMSTRONG CHASSIS

on CASH, C.O.D. or

EASY TERMS

ALL MODELS IN STOCK

After thorough tests we can fully endorse all Messrs. Armstrong claim for their new

MODEL S510

SUPERHET-STRAIGHT

10-v. ALL-WAVE RADIOGRAM CHASSIS

(See adv. opposite page)

At the turn of a switch this chassis has the unrivalled quality of a STRAIGHT set and the far-reaching capabilities of the most sensitive SUPERHET.

Unless something revolutionary in radio technique is unexpectedly developed, we are convinced that this set will remain an outstanding leader for a very long time and will prove to be a good investment.

CASH or C.O.D. Price 12 guineas or 27/- with order and 12 monthly payments of 18/4.

Illustrated literature giving full particulars of all models will be sent free upon request, with details of our convenient terms.

FULL RANGE IN STOCK. WRITE TO-DAY!

In addition to the Armstrong range, we shall be glad to quote for all other high grade equipment, such as Sound Sales Amplifiers, Voigt Speakers, Haynes Radio, Avometers, etc.

Estd. — 1925 Phone NATIONAL 6828

THE LONDON SUPPLY COMPANY
11 OAT LANE NOBLE ST LONDON EC2

M.R. SUPPLIES for Exclusive Modern Bargains

Did you see our interesting announcement in the advertisement columns of this journal last week? It will be well worth your while to refer back as we still have a few left of each item advertised—but we now have to advise early application. The following additional items are now offered:—

MINIATURE P.M. M/COIL UNITS. Only 3in. diameter. 15 ohms imp. perfect m/coil mikes—ideal for intercomm., 9/11. (Courtesy note to "waiting list customers"—stocks have now arrived and goods are being despatched immediately.)

ISMAY ("Blue Spot") ENERGISED M/COIL SPEAKERS, 8in. dia., with transformer. Field 10,000 ohms—right for universal or D.C., well made, fine response, handle 8-watts, to clear 7/11 each.

G.E.C. SPEAKER COUPLERS. Remarkable offer of the last few of these brand new 19/6 instruments, complete with full instructions. They protect speaker windings, assist matching and overcome instability on extension speakers. Final opportunity, 3/6 each.

SINGLE 'PHONES. (Standard Telephones.) Here's a long-awaited opportunity. Highly sensitive and suitable for all receivers. In fine black moulded casing, 2 1/2in. dia., 1/6 ea., or 2/6 pair.

SLIDING RESISTORS. Fully enclosed with laminated sliding brushes. Capacity 120-watts. Ideal for control of cine and other small motors. 400 and 600 ohms, either, 9/11.

WIRE-WOUND RESISTORS (Standard). On porcelain bobbin 1in. x 1in. Res. 400, 150, 120, 110, 85, 60 and 15 ohms. Capacity 15-watts. Tolerance 2 per cent. 43d. each, 3/9 dozen, or 12/6 for 50 assorted.

MINIATURE 20-WATT RESISTORS, only 1in. long, vitreous, 2,000 ohms only (Makers, Standard Telephones), 3d. each, 2/6 doz., or 50 for 8/-.

STANDARD RESISTANCE BOXES, by Elliott, Paul, Gambrell, Muirhead, etc. (Second choice requested). Total 120-ohms in 17 taps. Manganin elements. New or as new—all perfect, 35/-.

ELECTROLYTIC CONDENSERS. Two very special popular offers:—Plessey 8mf. (450 v. 8.) plus 24 mf. (350 v. 8.) Can type with nut and leads, 2/6 each. Hunts carboid tubular, 8 plus 8 mf. (120 v.) and 5 mf. (25 v.). Right for most midsets, 1/11 each to clear.

MILLIAMMETERS. First class spring controlled m/iron, A.C./D.C., 0/20, 0/50, or 0/250 m.a., 2in. dia. flush panel mounting, neat black finish, any one 7/9. These meters have been very favourably commented upon by "W.W."

VALVES. Final offers of new Tungram and Hivac. Following types at real clearance prices:—Battery:—VP215B and DDT215, any one 2/11, or three for 8/6. V/X/2 (Var. mu. hex.) 3/6. Mains:—DDT13, DD13, HI13 (all useful types), any one 2/9, or three for 7/6.

LINE COIL RESISTANCES for all American Midsets. American socket at one end and combined plug-adaptor the other, well made, 3/9.

G.E.C. MICROPHONE STANDS. Massively made, bronze, with square tilting frame within square outer frame. Telescopic Table, 15/6. Floor, with heavy claw-foot (List 45), 32/6. Heavy duty Tripod Floor Stands, completely rigid for rough outdoor positions and can be used as speaker tripods. Extend to 6ft., 22/6.

BIRCO ALL-WAVE ANTI-INTERFERENCE AERIALS (Latest from U.S.A.). Complete kit with two transformers, di-pole aerial, down-lead, insulators, etc., with fullest instructions, 14/11. Essential for ideal listening. Latest supplementary list sent with each order. Buy with confidence from the firm which NEVER DISAPPOINTED A CUSTOMER.

M. R. SUPPLIES, 68, NEW OXFORD ST., LONDON, W.C.1 (MUSEum 2958)

BLESSED IS HE THAT DOESN'T EXPECT

One might well expect to find their ideal Radio Set at the Radio Exhibition, and yet the ever increasing number of Sound Sales customers who appreciate that we are unfortunately unable to exhibit owing to the number of Government Contracts from all Departments on which we are actively engaged, will disagree with this conjecture. They know perfectly well that they found their own ideal Radio in Sound Sales Showroom, which is only 15 minutes from the West-End, and that it is not half so confusing to make a "sound" choice in every sense under these conditions.

Sound Sales' specialised Products sell themselves anyway!

If we are to be denied the pleasure of seeing you, may we send our latest Catalogue and Technical Manual, price 6d., which gives details of real quality Radios from £20-0-0, also our exclusive Tri-Channel system.

Specified by  the Experts

SOUND SALES

MARLBOROUGH RD. UPPER HOLLOWAY, LONDON, N.19. (Contractor to the G.P.O., etc.)

LIMITED. Tel.: Archway 1661/2/3

Hours of Business—Monday to Friday, 8.30 a.m. to 6 p.m.

SATURDAYS CLOSED

VACANCY EXISTS FOR RADIO TECHNICIAN

Component Development & Assist Research Dept.
Fulllest details to Box 904, c/o The Wireless World.

For PROMPT DELIVERY of High Quality

LOUDSPEAKERS, LOUD-SPEAKER CONES, LOUD-SPEAKER COMPONENTS, TRANSFORMER LAMINATIONS, TRANSFORMER HOUSINGS, TRANSFORMER WINDINGS, CHOKE WINDINGS, FIELD COIL WINDINGS, PERMANENT MAGNETS, PRESS TOOLS AND PRESSINGS, JIG BORING. AUTOMATIC SCREW MACHINE PARTS UP TO 2" DIAMETER.

Contractors to the Admiralty, War Office and Air Ministry

Call on **BRITISH ROLA LTD.**
MINERVA ROAD, PARK ROYAL, N.W.10.
PHONE: WILLESDEN 4322-3-4-5-6

VALVES

SPECIAL Line of Rogers and Majestic Tubes, types 551, 227, 551s, 55s, 6B7, 56 and 58, 2B7, 6 red 5 and 53; 3/6.

ALL Types of American Tubes in Stock of Impex and Arcturus makes at competitive prices.

WE Can Also Supply a Full Range of Guaranteed Replacement Valves for Any British non-ring, American or Continental type at an appreciably lower price.

SEND for Lists of These, and also electrolytic condensers, line cords, resistances, etc.

CHAS. F. WARD, 46, Farringdon St., London, E.C.4. Tel.: Holborn 9703. [0452]

AMERICAN, 2/9; 1,000 non-ring British from 1/9; bargains galore; lists free.—Shippers, 18, Corporation St., Manchester. [0607]

AMERICAN, 2/8; Tungram 2 amp. pentodes, 4/9; 4-pin vibrators, 6 or 12v., 9/6.—Superadio, Dantzic St., Manchester. [8854]

METROPOLITAN RADIO SERVICE.—Special offer. American valves, in maker's cartons, 3/- each, Octals, 3/6 each; American valves, first grade, in all types; trade supplied.—1021, Finchley Rd., N.W.11. Speedwell 3000. [0436]

METERS, ETC.

NEW Triplett 2,000 o.p.v. Meter, Model 1200A; offers.—Radio E18N, Longford, Ireland. [8842]

TEST EQUIPMENT

BEEDE 0/1 M/A Meter, 3 1/2 in., 100 ohm internal, 1,000 ohm shunts, 21/6.—Superadio, Dantzic St., Manchester. [8855]

COMPONENTS

SECOND-HAND, CLEARANCE, SURPLUS, ETC.

RADIO CLEARANCE, Ltd.

ALL Lines Previously Advertised Still Available.

ALL Orders Over 5/- Carriage Free; under this amount sufficient postage must be included with order.

ALL Enquiries Must Enclose 1 1/2d. Stamp.

RADIO CLEARANCE, Ltd., 63, High Holborn, W.C.1. Holborn 4631. [8858]

PREMIER SUPPLY STORES.

PLEASE See Our Displayed Advertisement on page 11. [0488]

RADIO SUPPLIES, Britain's Leading Mail Order House, offer the following brand new lines at unbeatable prices

THE Latest 1939-40 "Crosley" 8-valve Receiver, 4 waveband, 7 push buttons, 10 watts output, massively built cabinet finished in selected veneers, all in sealed cartons; £6/5.

LIMITED Number of the Latest "Air-King" 11-valve High Fidelity Receiver, 4 wavebands, 12 watts output, twin speakers, large Magnavox auditorium and tweeter, variable selectivity, large floodlit dial, magic eye tuning indicator, beautifully finished cabinet, listed at 25 gns.; exceptional value at £10/10.

1940 Battery Portables, 4-valve superhet, medium and long waveband, no accumulator required, complete with battery, very light for carrying, no aerial or earth required; £4/10.

AIR-KING 4-valve Midgets, A.C./D.C., 100-250 volt, medium and long waves; £2/15.

SPECIAL Offer in Car Radios to Motorists, just a few left, 1939 Travler, 6-valve, push button, 60R12 volt, one wave model; £4/10. Two wave model; £5/5.

TUNGSRAM Double Diodes, 6/- a doz.; magic eye holders, with 7-way cable, 9d. or 7/6 a doz.

CENTRALAB Pots, less switch, long spindle, 10,000, 50,000, 500,000; 1/- each or 11/- a doz.

AMERICAN Goat Cans; 2/- a doz. with base. Magnavox output transformers; 1/9 each.

GUARANTEED Boxed American Valves, 1st grade; G 2/3 each or 24/- a doz. 6A7, 78, 6D6, 6C6, 80, 84, 6X5, 6K7, 75, 6A8, 6Q7, 4L, 42, 80, 39/44, 38, 25Z5, 43, 18 and 6L16.

ROLA 8in. P.M.'s with Universal transformer; 8/6 each. Ferranti, 7-pin H.F. pentodes, type SPT4A; 2/9 each.

PHILIPS Pots, long spindle, mixed sizes; 3/- a doz. medium and long waveband pass coils, ideal for replacements; 9d. each, 6/- a doz.

RADIO SUPPLIES, 22, Faraday Avenue, Manchester, 8. Tel.: Col. 1261. [8861]

COULPHONE RADIO, Ormskirk.—6L6G octal valves, 3/6, boxed, guaranteed; 1 1/2d. stamp catalogues. [8849]

VAUXHALL.—All goods as previously advertised still available; write for free list.—Vauxhall Utilities, 163a, Strand, W.C.2 [8727]

SOUTHERN RADIO, 46, Lisle St., London, W.C. Ger-rard 6653.—Stocks of receivers and replacement components as previously advertised. [8548]

THE DENCO 1939/40 RANGE—

will include several new low loss components using polystyrene insulation, including variable condensers, coils etc. for transmission and reception, also a special range of S.W. receivers and converters of new design.

Full particulars will be given in our new catalogue ready on Sept. 1st. (Enclose 2d in stamps.)

Polystyrene insulation available from stock in sheet 1/8", 3/16" and 1/4", rod 1/4", 3/8" and 1/2" and tube 1/2", 3/4" and 1".

Our complete range will be on view at the R.S.G.B. EXHIBITION (STAND No. 11) at The Royal Hotel, London, W.C.1, Sept. 21st, 22nd and 23rd.

DENCO

(New Office and Works)
WARWICK ROAD,
CLACTON, ESSEX
Telephone 1387 and 770



"1940 RADIO INSIDE OUT."

NOW AVAILABLE.—A Revised Edition of this most popular Radio Manual. Up-to-date Chapters on Modern Receivers. Tabulated list of exact Service Replacements: Valves, Condensers, Volume and Tone Controls, etc. A host of practical hints for the Technician. Colour Codes, Charts, Technical Formulae, New Valve base connections, etc.

One Book in Three Sections. Available from W. H. Smith & Son and all Booksellers. **STAND No. 12, RADIOLYMPIA**

2/6

Published by **NORMAN ROSE (Electrical) LTD.**, WAREHAM ROAD, 45, Lamb's Conduit St., London, W.C.1.

RADIOMART

G5NI (BHAM) LTD.

THE SHORT-WAVE SPECIALISTS

SPECIAL OFFER!!!
Fully shrouded Transformer: by America's largest manufacturer. While they last.

AH 283 v. primary and fully impregnated.	
T28708—375/375 v. 150 m/A., 6.3V5A, 2.5V5A, 5V3A	15/-
T19610—350/350 v. 150 m/A., 2.5V6A, 2.5V2A, 5V3A	12/6
T7236—375/375 v. 120 m/A., 6.3VCT, 4A, 5V3A	10/6
T7326—350/350 v. 100 m/A., 6.3VCT, 3A, 3V3A	8/6
T7307—350/350 v. 80 m/A., 6.3VCT, 3A, 3V3A	7/6
T7000—320/320 v. 80 m/A., 6.3V4A, 5V3A	7/6
T6023—320/320 v. 80 m/A., 2.5V6A, 5V3A	7/6
T404919—10V1A Primary Tapped 110—250 v.	5/6
T1113AB—110/230 v. 500 watt Auto Transformer	20/6

The following choices are interwired and impregnated.

T7007—250 m/A., 135 ohms, 20-8 Hy., cadmium shrouded	12/6
T7007A—150 m/A., 250 ohms, 30-12 Hy., cadmium shrouded	12/6
100 m/A., 20 Hy., 500 ohms, unshrouded	4/11
60 m/A., 15 Hy., 250 ohms	1/11

HEAVY DUTY TRANSFORMER for models, bells, etc., 6 v. 3 a., 2/3 4 ml., 1,500 v. test 500 v. wkg. oil filled condensers, 2/-.

HEAVY DUTY Mains Transformer, worth 45/-, 350-550, 150 m/A. H 4 v. 2.5 a. CT. 4 v. 8 a. CT. 12/6; 300-500 v., 80 m/A., 4 v. 3 a. CT. 4 v. 2 a., CT. 6/6. Moving Coil Speaker Transformers, power, pentode or push pull, 1/11. WB Heavy duty ditto 2/11.

GANG CONDENSERS with Airplane Dial, 8 and 20-1. Cost 35/-. Few only. 4/11. Utility 2/6. Micaoid, 5/9.

W.B. 8in. PERMANENT MAGNET SPEAKERS AT ONE-THIRD COST Extension Type (no Transformer), 8/11. Standard Type (with Transformer) 10/6. Energised 8", 1200 ohms with Transformer, 6/11.

PUSHBACK Wire, 6 yds. 6d., heavy 9d. Resin-cored Solder, 6ft. 6d.; Screened Flex, single, 6d. yd.; twin, 9d. yd. Assorted Solder Taps, 6d. packet. Humdimmers 6d. each. Centralab pots, all sizes, 1/6 switched, 2/-; tubular fuses, 2d. Milliammeters, 25 m.a., upwards 5/9.

VALVES: Reliable replacements for all types, British and American, showing saving of over 50 per cent.

OUR NEW 66-PAGE MANUAL, packed full of valuable information. Communication receivers, transmitters, etc. 7th. post free.

THE NEW RAYBART CATALOGUE shows dozens of New Short-wave Components and is yours for 1 1/2d. post free. **TRADE ENQUIRIES** solicited for all types of communication equipment, transmitters, receivers, etc.

RADIOMART Telephone: MIDland 3254
G5NI (Birmingham) Ltd.
44, HOLLOWAY HEAD, BIRMINGHAM

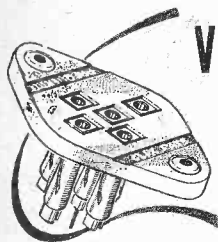

VALVEHOLDERS

The CLIX valveholder range covers patterns to accept all the recognised English and American valves, including Octal, Midget and Acorn types.

There is a specially designed Low-loss type having Frequentite bases fitted with Clix Patent Floating Sockets. The Frequentite base is protected against splitting when mounting on chassis, by the use of Clix metal inserts.

CLIX Valveholders are specified for the PRE-SET QUALITY RECEIVER

Here is the list of types specified:—

- 3. Type X.111. 4-pin Each 5d.
- 3. Type X.111. 5-pin " 6d.
- 2. Type X.112. 7-pin " 9d.

All contact-tubes are of the CLIX RESILIENT type, machined from the solid (not stampings) and, by a process involving helical slotting, are given a stout resilience which guarantees perfect contact irrespective of the valve-pin construction.

TRIMMER CONDENSERS

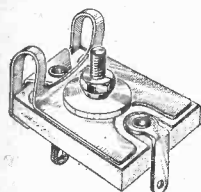

Here is another component in which the use of "Frequentite" Ceramic is unrivalled. The unique design of vane permits the condenser to be suspended in the wiring without "sag" and risk of any disturbance through any possible movement of connecting leads.

- Midget, Type R.480, single, variable 3-30 mmfd., and Type R.481, 4-50 mmfd. Each 6d.
- Double, Type R.482, 3-30 mmfd. " 116

Send for Clix Radio and Electrical Catalogue - Post Free



British Mechanical Productions Ltd., 79a, Rochester Row, London, S.W.1.

COMPONENTS—SECOND-HAND CLEARANCE, SURPLUS, ETC.

MAINS RADIO DEVELOPMENT COMPANY Offer Immediate Carriage Paid Delivery; call mornings. Telephone Tudor 4046. Stamp for List 250 (100 new season's bargains).

MICA Tag Condensers, 0.0001 to 0.002 T.C.C., Ormond, etc., six different sizes in each parcel of twelve for 1/-, thirty for 2/-.

T.C.C. 8 mfd. 600v. Peak Metal Can Dry Electrolytics, one hole fixing, 2/3; T.C.C. midget tubular card ditto, 1/6.

ERIE One-watt Colour Coded Unused Resistors, any size, 50 ohms to 5 megohms, your selection, 3d., 2/6 dozen; two-watt, 6d.

CENTRALAB Latest Potentiometers, long standard spindle, unused, all sizes, 5,000 ohms to 2 megohms, 2/-; with switch, 2/3.

TUBULAR Condensers, 400v. working, wire ends, best make, 0.0001-0.05 mfd., 4d.; 0.1 mfd., 4d.; 0.25, 0.5 mfd., 6d.

CLIX Unused Chassis Valve Holders, 5-pin, 7-pin, 3d.; American sizes, 6d.; best sleeving, 1/2d. yard.

FIFTY Unused N.S.F. 1/2, 1, 2-watt resistors, wire ends, marked and colour coded, 20 different useful sizes in each parcel; 50 for 2/6

MAINS RADIO DEVELOPMENT COMPANY, 4-6, Muswell Hill Rd., London, N.6. Tudor 4046. [8778

600V. Test 8 mf. Tubular Condensers, 1/3; Coaxial cable, 6d. yd.; Collaro gramophone motors, AC37, complete pick-up tone arm, 35/-; mixer auto changer, £5/5.—Superadio, Dantzic St., Manchester. [8856

RYALL'S RADIO, 280, High Holborn, London, W.C.1. —Goods previously advertised still available. [8846

VOIGT Latest Light Twin Coil, with B.B.C. corrector, reflector horn, field rectifier, W.W. P.A. 12-watt amplifier and 3 valve-leader, Haynes Model R.2 tuner, whistle filter, all perfect.—Offers to Sergeant, The Bristol, Paston Place, Brighton, 7. [8841

50 Assorted Condensers, 4/6; 50 assorted resistors, 4/6; 20 only Magic Eye tuning units with escutcheon, 2/6 each complete; 30 only American short wave coils, 4 in box, 10-200 meters, 2/6 per box; 4 only crystal mikes, 25/- each; stands for same, 5/- each; 1 only lapel mike, list price 2 gns., our price 25/-; 1 only 2 1/2 to 10 meter receiver, used, 50/-; all the above goods are brand new.—Reeves, 23, Meanwood Rd., Leeds. [8848

REPAIRS AND SERVICE

"SERVICE with a Smile."

AMERICAN Valves, spares, lineords, rewinds, repairs, of all types of American and British receivers.—E.R.I., Ltd., 22, Howland St., W.1. Museum 5675. [0434

LOUND-SPEAKER Repairs, British, American, any make, 24-hours' service; moderate prices.—Sinclair Speakers, Pultney Terrace, Copenhagen St., N.1. [0590

GUARANTEED Repairs, Any Transformers, choke, motor armature, converter, dynamo, etc., keenest prices, immediate quotation, prompt, dependable service.—See below.

L.T.P. (LONDON TRANSFORMER PRODUCTS, Ltd.), Willesden, N.W.10. Willesden 6486 (3 lines). [6892

MAINS Transformer Service, Repairs, rewinds, or construction to specification of any type, competitive prices and prompt service.—Sturdy Electric Co., Dip-ton, Newcastle-on-Tyne. [0516

METROPOLITAN RADIO SERVICE.—Guaranteed repairs to American and British receivers; American valves, service parts and rewinds, trade supplied.—1021, Finchley Rd., N.W.1. Speedwell 3000. [0435

REPAIRS to Moving Coil Speakers a Speciality; cones and coils fitted, fields altered; prices, including eliminators quoted; loud speakers, 4/-; L.F. and output transformers, 4/-, post free, guaranteed satisfaction, trade invited, estimates free; prompt service.—Loud-Speaker Repair Works, 5, Balham Grove, London. Battersea 1321. [0394

SITUATIONS VACANT

CROWN AGENTS FOR THE COLONIES.

COLONIAL Government Appointments.

APPPLICATIONS from Qualified Candidates are Invited for the Following Post:—

WIRELESS Engineer Required for the Posts and Telegraphs Department, Gold Coast, for three years, with possible permanency. Salary £450, rising to £720 a year. Free passages and quarters and liberal leave on full salary. Candidates, age 27-37, must possess the City and Guilds certificate in radio-communication, telephony and telegraphy, and have a thorough theoretical and practical knowledge of commercial wireless transmitters and receivers. They must be able to instal and maintain a wireless station, and to supervise repairs in the Department's Workshops. Preference will be given to General Post Office employees with some knowledge of modern trunk line circuits and to candidates with a knowledge of morse and ability to operate.

APPLY at Once by Letter, stating age, whether married or single, and full particulars of qualifications and experience, and mentioning this paper, to the Crown Agents for the Colonies, 4, Millbank, London, S.W.1, quoting M/5976. [8850

DRAUGHTSMEN Required (in the Midlands); used to small part mechanisms; write, giving particulars of experience, also state age and salary required.—Box 921, c/o The Wireless World. [8843

EFFICIENT SERVICE

requires

DEPENDABLE INSTRUMENTS

The same precision and intrinsic value that has been the feature of Everett, Edgcombe Industrial Instruments is built into RADIOLAB testing equipment.

ALL-PURPOSE TESTER



For example, the All-Purpose Tester (illustrated here) has A.C. and D.C. volt ranges 1-5-25-250 and 500. A.C. and D.C. current 1, 5, 25, 250 and 1,000 m.a. — 5 Capacity and 2 resistance ranges, and is

priced at £6 6s. 3d.

THE WORKSHOP TEST SET

is not merely a Resistance and capacity bridge but combines this feature with a continuously variable voltage supply for Leakage Current Testing on Electrolytic Condensers together with an Insulation Resistance tester and also a most useful valve Voltmeter having a range 5-100 volts. Price £8 0s. 9d.

ELECTROSTATIC VOLTMETER FOR TELEVISION SERVICE

3 RANGE VOLTMETER for A.C. and D.C. 0-2,000 0-4,000 0-8,000

£6.6.3 NETT.

as used by set manufacturers.

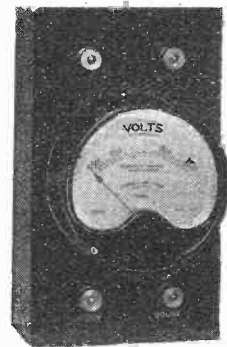

For further details, write for Sheet 730w.

EVERETT, EDGCUMBE & CO., Ltd. Colindale Works, London, N.W.9

Why Solon Electric Soldering is easier



Ordinary iron requires cleaning after heating

No cleaning with the Solon

Don't worry about flux or dirt. Use a Solon and Solon resin-cored solder. The resin runs out and acts as a flux. No dirt—the Solon is heated by the element clamped inside the bit. 15 hours' use for 1 unit. Ready for use in 4 minutes—maintains constant heat at the point.

Supplied complete with resin-cored solder, flex and lamp adaptor, 8/6.

Solon resin-cored solder, 6d. per reel.



W. T. Henley's Telegraph Works Co. Ltd. (Dept. 2/E), Holborn Viaduct, London, E.C.1.

ELECTRADIX

ILLUMINATED MILLIAMMETER: 8 m/a back of panel illuminated milliammeters (as illustrated). Skeleton type, 970 ohms D.C. with plain scale and lin. needle 2in. mica panel, back lamp and bracket. Neat and compact. Can be used as voltmeter with extra resistance. Great bargain at 3/9 post free. Bulgin Midgets, 8 m/a, 6/-; Sittim, 1 1/2 in., 10 m/a, 8/6. Moving Coil Milliammeters, all ranges in stock, 2,000 meters to select from.

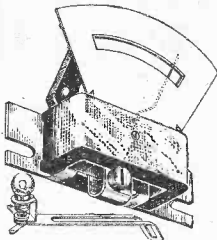

100 EMERGENCY ENGINE SETS. STUART Petrol Electric sets, water cooled, 150 watts coupled to 30 v., 5 amps. dynamo, £12. Larger size 50 v., 10 amps, 500 watts, £18.

A.R.P. WARDENS and Others.—Portable 'Phones in case, with handcomb, 45/-. Pocket Headphones, W.D., all leather headband, strap and cords, 2/6 pair. Wireless type with aluminium headbands, 2/9. 4,000 ohms, 4/6. Unbreakable Govt. Cable, 55/- mile. Portable Day and Night Signal Lamps, Addis or Lucas. Army type. Hand or tripod. Mains Bells for warnings, D.C. or A.C. Hand Generators for field or emergency transmitters (D.C.), 800 volts and 1,500 volts. Morse Inker Recorders for use when 'phone unsuitable, makes code message record on paper tape. Walnut cased, as new, portable field type, spring driven, with taper key and meter indicator, £7. Open G.P.O. type with tape reel in base, £5/10/-. A few soiled and incomplete, with perfect spring drive, 35/-. Dry coils work inkers, no radio needed. G.P.O. Sounders, 7/6. 3-colour light switch box with Morse Key fitted for code signals, 4/6. D.C. Generators, 500, 800 and 1,500 volts. Electric Motor Pumps, will deliver 120 galls. per hour 6ft. on a 12 v. car battery or mains, A.C. or D.C., £37/6. Electric Blowers, Foul Air Exhausters, 25/-.

ALARM BELLS.—BELLS for all purposes. House, wall and table 'phone bells for battery and mains. Single stroke per push Works Bells, Call Buzzers. Fire Alarm Bells and Pushes. First-class British, cheap.

WIND DYNAMOS. Start generating at 300 revs. up to 2,000 revs., 8/10 amps, ball-bearing, enclosed type, 35/-.

LUCAS AERO, 9/12 volts, 250 watts D.C. with enclosed Automatic Cut-out. Used on aircraft for L.T. supply to lighting, heating and wireless. Cost £15. Sale 25/-.

H.T. DIAL, cost £12. 600 volts, 100 m/a, and L.T. 6 volts, 5 amps. Sale 20/-.

HOME SOUND RECORDING AS AN AID TO LEARNING MORSE. The FEIGH RECORDER fits any Radio-gram, positive drive, worm gear and rack. Complete ready for use, only 37/6. Super Feigh Fidelity Set, 42/6. Tracking Gear only, 21/-. Blank Discs only, 3/3 per dozen. Pre-amplifiers for Recording Mikes, 1-valve Battery Model in cabinet, 25/-. A.C. Mains pre-amplifiers, with valve rectifier, steel-cased model, 60/-.

ELECTRIC LIGHT, 1,000 Porcelain Ceiling Roses with Ramie Junction Connectors, 3/- doz.

SMALL MOTORS. In almost new condition. 1/100th h.p. to 3/8 h.p. are offered at bargain prices. All voltages.

MOTOR BARGAINS in midge h.p., for A.C. or D.C. 200/230 volts, 1/110th h.p. D.O.T. type enclosed K.B., 2,000 revs., at a price never before offered, 7/6 only. Next larger G.M. No. 2 type, high speed, 1/60th h.p., 4,000 revs., 9/6. Larger, 1/45th h.p. Model G.E. No. 1, 12/6. All first rate for model driving or light duty.

EMERGENCY 12-VOLT LIGHTING SETS. "V" Dynamo sets for use with 12-volt battery, 12/16 volts, 10 amps. Enclosed, ball bearings, Vee pulley, 35/-. Switchboard for same with ammeter, max.-min. auto cut-out and in. Main Switch and Fuses. The set 65/-. Generator only, 35/-. C.Z. Meter, 7/6. 30 AMP. 1/2 k.w. Model T.B. Generator, 12/16 volts, 45/-. A.C. D.C. Crypto Constant Potential Charger for 220 volts single phase with output, D.C. of 8 volts 50 amps. and 100 volts 1 amp.

SWITCH-GEAR, CIRCUIT BREAKERS, 3 single-pole, open type breakers—50 amps., adjustable trip, each 27/6. One single-pole open type 200 amp. time lag 5 to 20 secs., 60/-. S.P. Small Circuit-breakers, totally enclosed, up to 4 amps., 6/6, with thermal delay trip, 10/-; 10 amps., 14/-; 20 amps., 18/6. Also in D.P. and triple. 100 amp., 600 v., D.P. Ironclad Switch, 20/-.

CONTACTORS, S.P., 5 to 15 amps., A.C. and D.C., 100 v., 220 v., 250 v., 67/6. Mercury Switches, 230 volt, D.P., 22/-. 15 amps., S.P., 20/-; D.P., 25/-. With time lag of 30 secs., 15 amps., 220 volts, 35/-. Two Starter 20 amps., S.P. Ironclad, 220 volts, D.C. coil, 25/-. Three 4-pole or twin D.P. open type Contactors on bakelite panel, 25 amps., 220 v., D.C. coils, 27/6. Triple ditto and two on one, 25/-. Battery charge autos, 15 amps., 10/6. X-Ray Time ex-Switch, 1/2 to 15 secs. trip, hand type, 40/-.

5/- BARGAIN PARCEL of 10 lb. of components: resistances, tubulars, micas, variables, wire steering, vol. controls, coils, magnets, chokes, switches, mouldings, terminals, etc., post free; 10 lb., 5/-.

Over 1,000 other Bargains in our enlarged Illustrated List "W"

ELECTRADIX RADIOS
218, UPPER THAMES STREET, LONDON, E.C.4
Telephone: Central 461x

ENGINEERS! ARE YOU EARNING LESS THAN £10 PER WEEK?

If so, you cannot afford to carry on without reading our 268-page Handbook. The book explains clearly and definitely many ways of carving out a successful career. Among other things it explains the Services of our unique Appointments Department: outlines Home-Study Courses in all branches of Civil, Mechanical, Electrical, Motor, Aero, Wireless, "Talkie" Engineering, Building, Govt. Employment, etc., and gives details of B.Sc., A.M.I.C.E., A.M.I.E.E., A.M.I.Mech.E., A.M.I.A.E., A.M.I.W.T., A.M.I.R.E., A.M.I.R.E., G.P.O., MATRIC, and all Exams. We Guarantee — "NO PASS—NO FEE." Whether you be an old hand or a budding apprentice get this book to-day. FREE and POST FREE.

BRITISH INSTITUTE OF ENGINEERING TECHNOLOGY,
337, Shakespears House, 17/19, Stratford Place, London, W.1.

268 PAGES Free!

SITUATIONS VACANT

AIR Ministry.

REF. No. A.337 I. Draughtsmen, Grade I, required at the Royal Aircraft Establishment, South Farnborough, Hants, for each of the following classes of work:—

- (A) Detail design work on light mechanical and electrical apparatus.
- (B) In connection with the design of aircraft and other instruments.
- (C) Detail design work on aircraft equipment. A knowledge of aircraft armament is desirable, but not essential.
- (D) Illustration of technical publications. A general knowledge of aircraft and aircraft engines is desirable.
- (E) In connection with the design of wireless apparatus. Candidates should have had good technical training in electrical engineering and drawing office, and workshops experience on radio, telephone or scientific instrument work, or work of an allied character.

CANDIDATES for the Above Posts should have had Good Technical Training and Workshops and Drawing Office Experience of a Character Appropriate to the Post for which application is made.

SALARY Scale:—£220 a year, rising by annual increment of £10 to £260 a year, and thence by £12 to £330 a year. Commencing salary up to £260 a year, according to qualifications and experience. Also

REF. No. A.338. I. Several Draughtsmen, Grade II, for work in the above categories.

SALARY Scale:—Up to 82s. a week, commencing salary according to qualifications and experience.

THE Appointments are Non-pensionable. Entrants to Grade I will be eligible for consideration for appointment to pensionable posts in the event of vacancies arising on the permanent establishment. Promotion from Grade II to Grade I is governed by merit.

REQUESTS for the Necessary Application Form should be made (quoting the appropriate reference No.) to the Chief Superintendent, Royal Aircraft Establishment, South Farnborough, Hants, enclosing stamped addressed envelope. The closing date for the receipt of form is 8th September, 1939. [8845]

YOUNG Men with Experience of Wireless Operating.

REQUIRED for Three Years' Service as Constables in the Palestine Police Force. Pay £11 a month (plus trade pay of £3 per month when employed as Wireless Operators), uniform, rations and quarters. Free passages and leave on full pay. Candidates, age 21-28, must be single, of good physique and physically fit, and must hold a Postmaster-General's Certificate in wireless telegraphy. Apply, stating exact age, height and particulars of education and training, to the Crown Agents for the Colonies, 4, Millbank, London, S.W.1. Head your letter "Palestine Police." [8851]

EXPERIENCED Television Serviceman Required for Indoor and Outdoor Work. Also vacancy for Valve and C.R.T. Tester, with manufacturing experience; only written applications considered; state age, education, previous trade experience, and if owner-driver.—G.E.C. Service Depot, Greycoat St., Westminster, S.W.1. [8844]

ELECTRIC DRY SHAVERS

REMINGTON. Rand, Shavemaster, Packard, Casco, Rabaldo.—Trade enquiries to Leonard Heys, 36, Henry St., Blackpool. [0633]

MISCELLANEOUS

CHEAP Printing.—1,000 billheads, 3/6; sample free.—Creteway Press, 18, Buxted, Sussex. [8180]

EVERY Radio Dealer Who is Not a Regular Reader send his trade card at once for a specimen copy and full details of the "Trader" Services. The Wireless and Electrical Trader has the widest influence, the largest weekly circulation, and is read by all the leading manufacturers and traders. Trade only. 15/- per annum, post free.—Published at Dorset House, Stamford St., London, S.E.1. [0615]

"ENGINEER'S Guide to Success" Shows How to Quality in Television Radio Engineering and Servicing, sound, recording, wireless communicating, etc., by studying at home with the T.I.G.B. Write to-day for this Great Guide—free—which gives full particulars, contains the world's widest choice of engineering courses—over 200—and alone gives the regulations for qualifications such as A.M.I.E.E., A.M.I.R.E., A.M.I.T.E., A.M.I.W.T., C. and G., etc. Training until successful guaranteed.—The Technological Institute of Great Britain, 82, Temple Bar House, London, E.C.4. (Founded 1917. 20,000 successes.) [8782]

PATENT AND TRADE MARK AGENTS

GEE and Co. (H. T. P. Gee, Mem. R.S.G.B., etc.), 51-52, Chancery Lane, London, W.C.2. Holborn 4547-8. Handbook free. [0001]

TUITION

RADIO Training.—P.M.G. exams and I.E.E. Diploma; prospectus free.—Technical College, Hull. [0611]

PRACTICAL Postal Courses, radio television; test equipment design; I.P.R.E. and I.W.T. exams.—Write I.P.E., 3, Shirley Rd., London, W.4. [8838]

WIRELESS.—Complete training Marine, broadcast and television; posts waiting; mod. fees; boarders taken; approved college, prosp.—Dept. W, London Radio College, Grove Park Rd., London, W.4. (Chi. 3244.) [0580]

Come and refresh your ears!

DURING RADIOLYMPIA

at
2, BEACONSFIELD TERRACE RD.

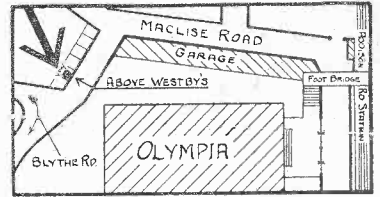

11 to 1 and 3 to 10.30 (half-hour after Olympia closes).

VOIGT PATENTS LTD.

THE COURTS, SILVERDALE, LONDON, S.E.26

Telephone: Sydenham 6666 Regd. Office: 22, Castle Street, E.C.1

THE INSTITUTE OF WIRELESS TECHNOLOGY

(Founded in 1925. Incorporated.)
EXAMINATION ENTRIES
Candidates for the November Examinations must apply not later than September 30th.
Application Forms and Syllabus may be obtained from the Secretary:—Harrie J. King, F.C.C.S., Institute of Wireless Technology, 4, Vernon Place, Southampton Row, London, W.C.1.
Phone: Holborn 4879.

Lockwood CABINETS

ACOUSTICALLY DESIGNED
A complete range for all Wireless World Receivers and Commercial Chassis
Special Drawings free on request
Send 1½d. stamp for details of Standard Models
Lockwood & Co., 65, Lowlands Road, Harrow
Telephone: Byron 1313

Pamphonic AMPLIFIERS

Pamphonic Reproducers Ltd. (Associated with P.Y.E. Ltd.)
45, St. Pancras Way, London, N.W.1.
Phone: EUSton 1727.

THE NORTHERN POLYTECHNIC, HOLLOWAY ROAD, N.7.

Department of Musical Instrument and Radio Technology.

Head of Department: S. A. Hurren, M.I.R.E., F.I.W.T.
Day and Evening Courses in

RADIO SERVICING AND TELEVISION SERVICING

in preparation for all recognised qualifications in these subjects. Practical laboratory and workshop experience provided.
Prospectus free on application to Secretary.
New Term begins September 11th.
Evening Enrolment September 21st and 22nd.

Third Edition of

WIRELESS DIRECTION FINDING

BY R. KEEN, B.Eng.

A BOOK OF INSTRUCTION AND REFERENCE FOR ENGINEERS, TECHNICIANS, TELEGRAPHISTS AND OTHERS ENGAGED OR INTERESTED IN THE USE OF DIRECTIVE WIRELESS TELEGRAPHY FOR THE NAVIGATION OF SHIPS AND AIRCRAFT.

The third edition of this well-known book deals with the principles of Wireless Direction Finding and gives an account of the circuits and apparatus used in its application to navigation. The Adcock Aerial has a separate chapter covering its principles together with much information on its installation and performance. Further chapters are included on Shore, Ship and Aircraft installations as well as a special section on the choice of a suitable site for the Aircraft Ground D.F., with Adcock Aerials.

Engineering students and research engineers will find useful references to a selected list of some 600 of the more important contributions to the literature of D.F.

800 pages 550 illustrations

PRICE:

25/- net By post 25/9

ILIFFE & SONS LTD., DORSET HOUSE, STAMFORD STREET, LONDON, S.E.1

W.W. 00

BUSINESSES AND PROPERTY FOR SALE, TO BE LET, OR WANTED

"THE Wireless and Electrical Trader" is an essential part of the equipment of every Wireless Trader; its pages reflect the very latest turn of trade events, and it is read by all the leading dealers and manufacturers, for particulars of businesses offered or wanted. By subscription to the trade only, 15/- per annum, post free.—Send your trade card for specimen copy to Dorset House, Stamford St., London, S.E.1. 10614

BOOKS, INSTRUCTION, ETC.

AMERICAN Valve Data.—The 200-page Raytheon Data Book gives full characteristics, applications, all types American valves; invaluable to servicemen; post free anywhere; 2/3.—Leonard Heys, 36, Henry St., Blackpool. 10594

ALL Wireless and Radio Engineering Books Available through new financial terms as low as 2/6 monthly.—Write a card or call personally for details and lists from the Radio Department, Phoenix Showrooms, 66, Chandos Place, Strand. 18623

ELEMENTARY Principles of Wireless Telegraphy and Telephony." By R. D. Bagnay. Revised by O. J. Brown, B.Sc. Third edition (1930). The standard textbook for wireless students and beginners. Deals with the whole subject of wireless telegraphy and telephony, avoiding too technical a treatment of the problems involved. Well illustrated. Price 7/6 net. By post 8/- from Iliffe and Sons Ltd., Dorset House, Stamford St., London, S.E.1.

"THE Wireless World" Diary for 1939 contains 77 pages of facts, formulae and general information of the kind that is always wanted but is difficult to follow. Also a list of the most important European Broadcasting Stations and short-wave stations of the world. Twelve pages of circuit diagrams of receivers, amplifiers and units.—By post 1/7 from Iliffe and Sons Ltd., Dorset House Stamford Street, London, S.E.1.

FOUNDATIONS of Wireless." By A. L. M. Sowerby, M.Sc. Second edition. An elementary textbook on receivers. Deals fully with the construction of wireless sets, valves, and the process of detection. Price 4/6 net. By post 4/11, from Iliffe and Sons Ltd., Dorset House, Stamford Street, London, S.E.1.

RADIO Data Charts." By R. T. Beatty, M.A., B.E., D.Sc. Second edition. A series of Abacs providing most of the essential data required in receiver design and enabling problems to be solved without having recourse to complicated mathematical formulae. Price 4/6 net. By post 4/10, from Iliffe and Sons Ltd., Dorset House, Stamford Street, London, S.E.1.

Fourth Edition—

WIRELESS SERVICING MANUAL

By W. T. COCKING

(of "The Wireless World")

The most complete book of reference of its kind. A reliable practical guide for amateur and professional.

The "Wireless Servicing Manual" deals fully with Testing Apparatus, and explains the methods of locating and curing faults in receiving equipment. Includes a special chapter on Television Receivers.

Ganging, Automatic Volume Control, Instability, Distortion, Mains Hum, Whistles and Local interference, are all separately treated. There is also a special chapter on the Aerial-Earth System.

Information on short-wave receivers, and on methods of operating extension loud speakers, has been added. The reference material, including base-connections for British, Continental and American valves, and the various colour codes for components, has been extended and brought up to date.

5/- net By post 5/5

Issue! in conjunction with "THE WIRELESS WORLD" and Published by the Proprietors—

ILIFFE & SONS LTD., DORSET HOUSE, STAMFORD ST., LONDON, S.E.1

W.W.20

PREMIER RADIO STOCKTAKING SALE SPECIAL CLEARANCE OFFERS!

IGRANIC WIRE WOUND POTENTIOMETERS, 3 watt rating, 2,500 ohms, 5,000 ohms, 10,000 ohms, 50,000 ohms, 2/- each.

POTENTIOMETERS WITH SWITCH, 1/2 meg., 1 me., 20,000 ohms and 10,000 ohms, 1/3 each.

POTENTIOMETERS WITHOUT SWITCH, 2 meg., 1 meg., 1/2 meg., 400,000 ohms, 25,000 ohms, 20,000 ohms, 10,000 ohms, 1/- each.

SPECIAL OFFER—CONTINENTAL MAINS VALVES, 4 v. AC Types, 5-pin only, AC/HL, AC/L, AC/P, AC/SG, AC/VMS, AC/HP, AC/VHP, 2/6 each.

F.W. RECTIFIERS, 350v. 120ma., 4/6; 500v. 120 ma., 5/6. 20 v. 18a AC/DC Types, SG. Var. Mu., SG. Power, HF Pen., 2/- each.

U.S.A. Types, 24, 30, 41, 39/44, 35/51, 55, 53, 57, 58, 71, 77, 78, 85, 2A5, 2A6, 2A7, 2B7, GA7, 12Z3, 210, 250, all 2 for 3/-.

TUBULAR CONDENSERS, .002, .0031, .0003 and .0005 mfd., 1/- doz. Your choice.

ELECTROLYTIC CONDENSERS. Metal Can. 8 mf. 320 volts, 2 for 1/6. 8+8 mf. 475 v.-10 mf. 50 v. 2 for 2/6. 8+8 mf. 450 v.+8 mf. 250 v., 2 for 2/6.

T.C.G. DRY ELECTROLYTICS. 8+8+4 mf. 500 v. 2/- each.

500 v. CARDBOARD ELECTROLYTICS. 4 mf. or 8 mf. 1/6. 8+4 mf. 2/9. 8+8 mf. 2/6. 4+4 mf. 2/4.

MAINS TRANSFORMERS—MANUFACTURERS' SURPLUS. 250—250 v. 60 ma., 4 v. 2 a., 13 v. 1 a., 3/6. 300—350 v. 60 ma., 4 v. 1—2 a., 4 v. 3—4 a., CT, 6/11.

We haven't room here to tell you all about our new lines, but details of our vast range will be found in the new

PREMIER 1940 CATALOGUE

111 PAGES — PRICE 6d.

Over 20 Pages of British and U.S.A. Valve Data

Receivers, Transmitters, Amplifiers, Components.

GET YOUR COPY TO-DAY!

HUGE REDUCTIONS IN U.S.A. VALVES

PREMIER SHORT-WAVE KITS. Complete to the last detail including all Valves and coils, as well as theoretical and wiring diagrams and lucid instructions for building and working. Each kit is supplied with a steel Chassis and Panel and uses plug-in coils to tune from 13 to 170 metres.

1 Valve Short-Wave Receiver or Adapter Kit ... 17/6

1 Valve Short-Wave Superhet Converter Kit ... 20/-

1 Valve Short-Wave A.C. Superhet Converter Kit ... 22/6

2 Valve Short-Wave Receiver Kit ... 25/-

3 Valve Short-Wave Screen Grid and Pentode Kit ... 58/6

PREMIER U.S.A. QUARTZ TRANSMITTING CRYSTALS

7 mc Band, 10/- each, with Calibration Certificate. Enclosed holder and base, 3/-.

MORSE KEYS. Excellent brass movement on bakelite base, 2/9 each.

PREMIER SHORT-WAVE COILS, 4- and 6-pin types, 13-26, 22-47, 41-94, 78-170 metres, 1/9 each, with circuit.

Special set of S.W. Coils, 14-150 metres, 4/- set, with circuit. Premier 3-band S.W. coil, 11-25, 19-43, 38-86 metres. Suitable any type circuit, 2/6.

UTILITY Micro Cursor Dials, Direct and 100:1 Ratios, 3/9.

PREMIER Short-Wave Condensers, all-brass construction, with Trolitul insulation. 15 mmf., 1/6; 25 mmf., 1/7; 40 mmf., 1/9; 100 mmf., 2/-; 160 mmf., 2/3; 250 mmf., 2/6.

TROLITUL DOUBLE SPACED TRANSMITTING CONDENSERS. 15 mmf., 2/9; 40 mmf., 3/6; 100 mmf., 4/-; 160 mmf., 4/6.

PREMIER BATTERY CHARGERS. Westinghouse Rectification. Complete. Ready for use. To charge 2 volts at 1 amp., 10/-; 6 volts at 1 amp., 16/6; 6 volts at 1 amp., 19/6; 12 volts at 1 amp., 21/-; 6 volts at 2 amps., 32/6.

COIL FORMERS, 4- or 6-pin low-loss, 1/- each.

Orders 5/- and over sent Post Free. Under 5/- please add 6d. Postage.

ALL POST ORDERS TO: Jubilee Works, 167, Lower Clapton Road, London, E.5. Amhurst 4723

CALLERS TO: Jubilee Works, or our NEW PREMISE: 169, FLEET STREET, E.C.4. Central 2833

or 50, High Street, Clapham, S.W.4. Macaulay 2381

THE WIRELESS ENGINEER

The Journal of Radio Research and Progress.

Monthly 2s. 6d. net.

ILIFFE & SONS LTD., Dorset House, Stamford St., London, S.E.1

We do quite a lot of business making up trans-formers to customers own specifications; but we have a standard list. May we send you a copy?



W. BRYAN SAVAGE LTD

Westmoreland Rd., London, N.W.9. Phone: Colindale 7131

RADIO LABORATORY HANDBOOK

By M. G. SCROGGIE, B.Sc., A.M.I.E.E.

issued in conjunction with "The Wireless World"

384 pp.

211 illustrations

PRICE 8/6 NET

By post 9/-

"Radio Laboratory Handbook" is the only practical and reliable handbook on the subject. It gives the serious wireless worker complete information from first-hand experience about laboratory equipment, the instruments which are necessary and the correct methods of operating them.

The fundamental principles are fully discussed, as well as the sources of power and signals, instruments and measurements. Other sections deal with ultra-high-frequency work, the working out of results, and reference data. There is also a collection of the most useful symbols, abbreviations, formulae, laws, curves, tables and other data.

A complete index, numbered sections and cross references enable the reader to find what is required without loss of time.

From Bookstalls and Booksellers or direct from the Publishers

ILIFFE & SONS LTD., DORSET HOUSE, STAMFORD STREET, LONDON, S.E.1

INDEX TO ADVERTISEMENTS

	PAGE		PAGE		PAGE
Ambassador Radio Works	7	Fluxite, Ltd.		Partridge, N.	
Armstrong Manufacturing Co.	6	Garrard Eng. & Mfg. Co., Ltd.	3	Peto-Scott, Ltd.	11
Automatic Coil Winder Co., Ltd.	1	General Electric Co., Ltd.	2	Premier Radio Stores	11
Belling & Lee, Ltd.		Goodmans Industries, Ltd.	5	Rose, Norman	8
Birmingham Radiomart G5N1	8	Henley's, W. T., Telegraph Works Co., Ltd.	9	Salford Electrical Co., Ltd.	Inside Front Cover
Birmingham Sound Reproducers, Ltd.		H.M.V.	Back Cover	Savage, W. Bryan, Ltd.	11
British Institute of Engineering Technology	10	Institute of Wireless Technology	10	Scophony, Ltd.	
British Mechanical Productions, Ltd.	9	Lockwood & Co.	10	Sound Sales, Ltd.	8
British Pix		London Radio Supply Co.	7	Steatite & Porcelain Products, Ltd.	4
British Rola Co., Ltd.	8	McClure, John, Ltd.	12	Taylor Electrical Instruments	
Bulgin, A. F. & Co., Ltd.		M.R. Supplies	7	Varley, Ltd.	
Cossor, A. C., Ltd.		New Times Sales Co.	10	Voigt Patents, Ltd.	10
Degalliers		Northern Polytechnic	10	Vortexion, Ltd.	7
Denco	8	Pamphonic Reproducers, Ltd.	10	Westinghouse Brake & Signal Co.	Inside Back Cover
Dubilier Condenser Co., Ltd.	4			Whiteley Electrical Radio Co., Ltd.	3
Edgecumbe, Everett & Co., Ltd.	9			"World Radio"	5
Electradix Radios	10				

McCLURE HANDBUILT RADIO

SUPER COMMUNICATIONS RECEIVER

This is a first class set incorporating every desirable feature. The "R" meter works well on both CW and Phone, noise level is exceptionally low while the B.F.O. does not bring up background noise. Sensitivity better than one microvolt on all bands.

BRIEF SPECIFICATION.

13 valves. 9 to 600 Metres. 5 bands, no gaps. Electrical Band-spread. HF on all bands. HF gain control. Two 465 Kc Iron cored I.F.s. Continuously Variable Selectivity. BFO with variable pitch and zero beat adjustment. Variable delayed AVC, separate valve amplifies DC. Undelayed amplified "R" meter. Differential crystal gate. Two phone jacks. Separate RF Oscillator. Standard rack size. Two AF stages, 6L6 OP. 4,000, 2,000 and 1.5 ohms O.P. Dipole and single aerial input. Illuminated dial. Steel cabinet chromium and black crystal finish.

Price £27.10.0

I.P.T. Terms can be arranged.

Write: Edward Thomas, Facilities Dept.,

JOHN McCLURE LTD., (66JM)

ERSKINE RD., LONDON, N.W.3. PR11956-6

Every McClure product incorporates the latest refinements and is designed with unlimited care to do its work faithfully and to give efficient and lengthy service.

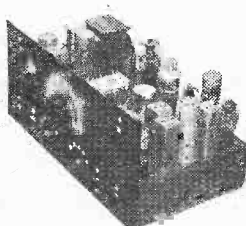

SECOND EDITION

—Completely Revised

RADIO DATA CHARTS

A SERIES OF ABACS

Providing most of the essential Data required in receiver design

By R. T. BEATTY, M.A., B.E., D.Sc.

PRICE 4/6 net

BY POST 4/10

From all leading booksellers, or direct from the Publishers. Published from the offices of "THE WIRELESS WORLD," DORSET HOUSE, STAMFORD STREET, LONDON, S.E.1

W.W.93

RADIO INTERFERENCE SUPPRESSION

By

GORDON WM. INGRAM, B.Sc.

An invaluable book for every electrical and radio engineer, which will also be appreciated by servicing experts and wireless enthusiasts.

It classifies types and causes of interference and their remedy. The text and three appendices provide immediate and practical analysis of causes, whilst the subdivision of electrical apparatus into groups makes for easy reference.

The contents include:— Coloured supplement: Interference Diagnosis.

Sections on:—The nature of electrical interference and its classification. The production of interference by electrical plant. Technical considerations and the design of suppression apparatus. The industrial application of suppression. Tables and Reference List.

Appendices:—Interference Classification Table—Suppression Method Table—Anti-Interference Aerials.

162
PAGES

60
ILLUSTRATIONS

PRICE

5/-
NET
By post 5/3

BINDING
CLOTH BOARDS

SIZE
7½" x 5"



YOU NEED THIS BOOK

You can get a copy from STAND 30, RADIOLYMPIA, or, if you are not visiting the Exhibition, one will be sent you by return on receipt of the coupon and 3d. in stamps.

“The All Metal Way” contains 56 pages of technical information and circuits relating to rectification and includes chapters on television H.T. supply, telephony monitoring, reduction of interference, etc.

NOW READY
Obtainable direct or through any Bookseller.

Published by

ELECTRICAL REVIEW LTD.
DORSET HOUSE
STAMFORD STREET
LONDON S.E.1

-----COUPON-----

WESTINGHOUSE BRAKE & SIGNAL CO., LTD.
82, York Way, King's Cross, London, N.I.

Please send me a copy of “The All Metal Way” for which I enclose 3d. in stamps.

Name.....

Address.....

W.W. 31/8/39



*Advanced Listening
in 1940 with*

"HIS MASTER'S VOICE"

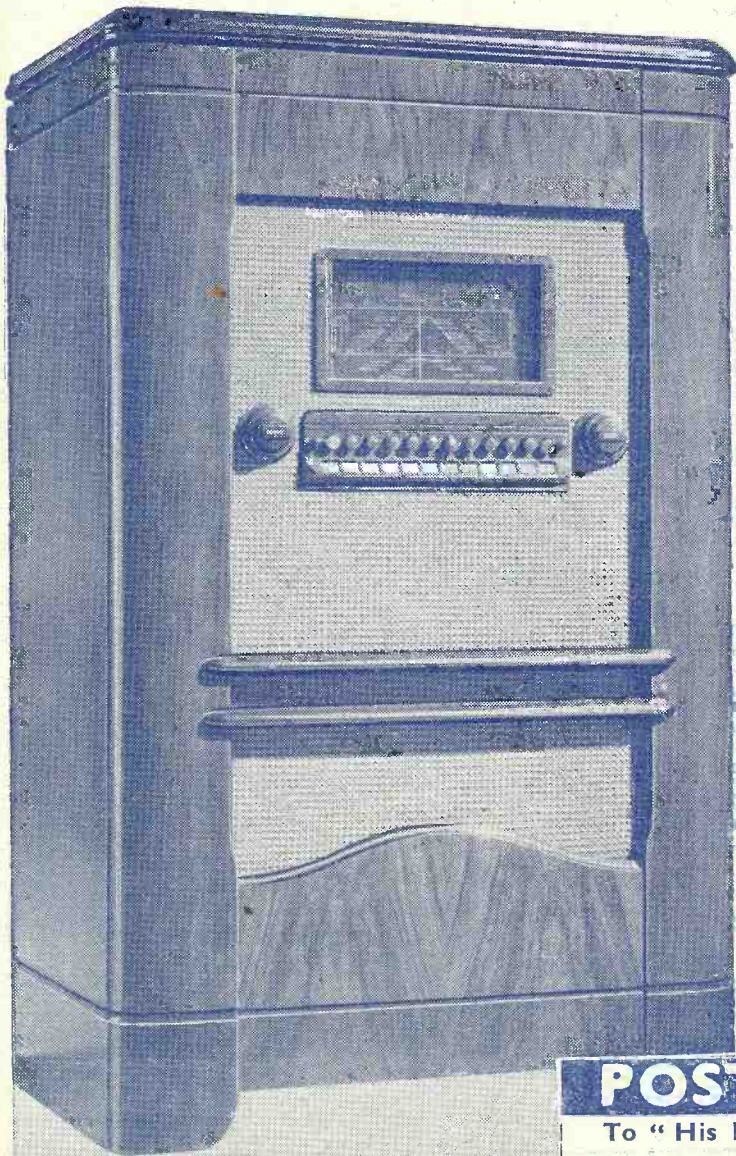

MODEL 1500. "H.M.V." 6-valve all-world Superhet Radiogram, with push-button tuning on radio, and music of your own choice on the electric gramophone. — 24 GNS. or by hire purchase.

By achieving perfect naturalness in the reproduction of every word, note and sound "His Master's Voice" technicians have provided radio enthusiasts with "advanced listening" for 1940 . . .

Important "H.M.V." technical advances enable you to derive greater enjoyment from broadcast transmissions, and to elicit from your favourite records a tonal realism hitherto unrealised . . . Beautiful cabinets combine accurate acoustic matching with the appeal of good furniture.

In high definition television, too, "H.M.V." offer you at popular prices, more vivid and reliable reception. Ask for a demonstration at your dealer, and/or post the coupon.



POST THIS COUPON NOW

To "His Master's Voice," 98-108, Clerkenwell Road, London, E.C.1.

I should be pleased to receive a copy of your coloured booklet illustrating the complete new range of "His Master's Voice" * { Radio Instruments. Television Receivers.

NAME.....

ADDRESS.....

* Cross out item not required.